

**ΤΕΥΧΟΣ ΕΞΑΣΦΑΛΙΣΕΩΝ
ΠΟΛΥΓΩΝΟΜΕΤΡΙΚΟΥ ΔΙΚΤΥΟΥ ΤΩΝ ΠΕ 08 & ΠΕ 10**



**Σ Π Υ Ρ Ι Δ Ο Π Ο Υ Λ Ο Σ Β.
Γ Ρ Η Γ Ο Ρ Ι Ο Σ**

**Ι Ω Α Ν Ν Η Χ Α Λ Κ Ι Δ Η 63
Α Μ Π Ε Λ Ο Κ Η Π Ο Ι**

**Τ Η Λ Γ ρ α φ . : 2 3 1 0 7 2 5 9 0 0
 Κ ι ν . 6 9 3 6 8 6 5 6 2 4**

Α ρ . f a x : 2 3 1 0 7 2 5 9 0 0

Η μ ε ρ ο μ η ν ι α : 1 / 6 / 2 0 1 1

ΤΙΤΛΟΣ ΜΕΛΕΤΗΣ:

**« Ο Ρ Ι Ζ Ο Ν Τ Ι Ο Γ Ρ Α Φ Ι Κ Η & Υ Ψ Ο Μ Ε Τ Ρ Ι Κ Η Α Π Ο Τ Υ Π Ω Σ Η
Ο Δ Ω Ν Γ Ι Α Μ Ε Λ Ε Τ Η Α Ν Α Π Λ Α Σ Η Σ Τ Ω Ν Π Ο Λ Ε Ο Δ Ο Μ Ι Κ Ω Ν
Ε Ν Ο Τ Η Τ Ω Ν Π Ε 0 8 & Π Ε 1 0 Τ Η Σ Δ Η Μ Ο Τ Ι Κ Η Σ
Κ Ο Ι Ν Ο Τ Η Τ Α Σ Α Μ Π Ε Λ Ο Κ Η Π Ω Ν »**

S7A
 X= 408534.019
 Y=4500830.395
 H= 17.705
 E1= 4.06
 E2= 7.73
 E3= 16.14

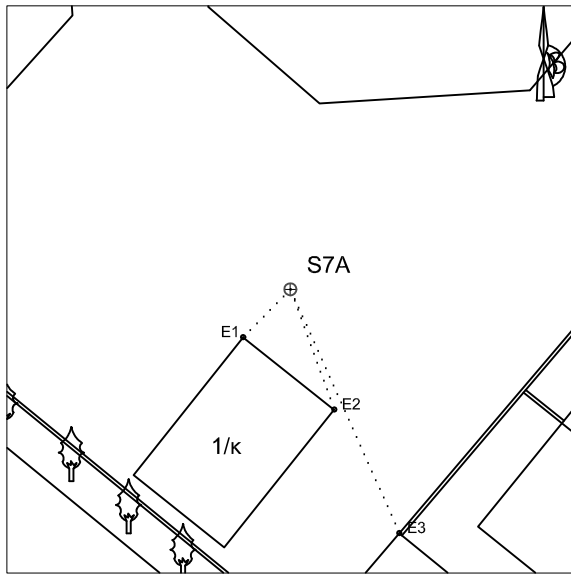

S108
 X= 408533.938
 Y=4500794.484
 H= 17.469
 E1= 12.3
 E2= 8.93
 E3= 11.33

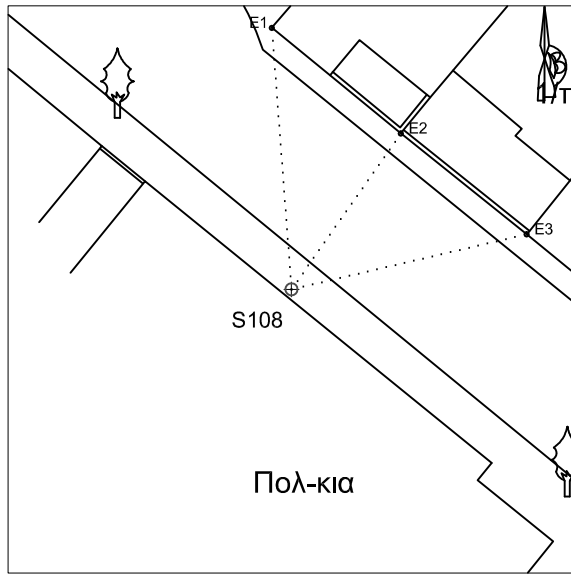

S109
 X= 408557.073
 Y=4500776.662
 H= 17.274
 E1= 12.42
 E2= 14.46
 E3= 11.04

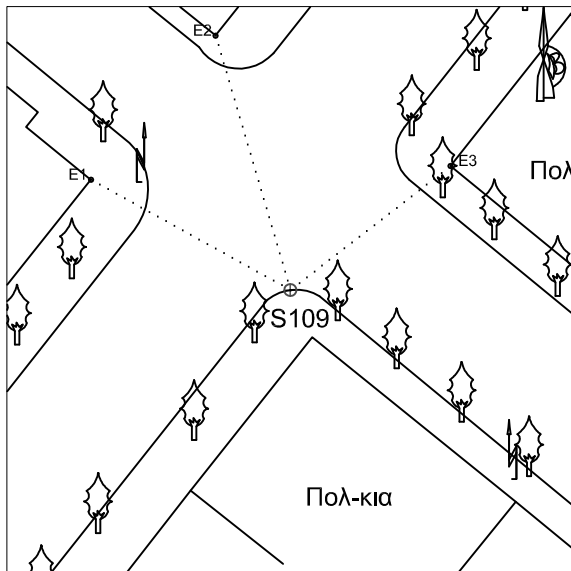

S110
 X=408518.03
 Y=4500745.096
 H= 16.923
 E1= 0.83
 E2= 7.19
 E3= 14.26

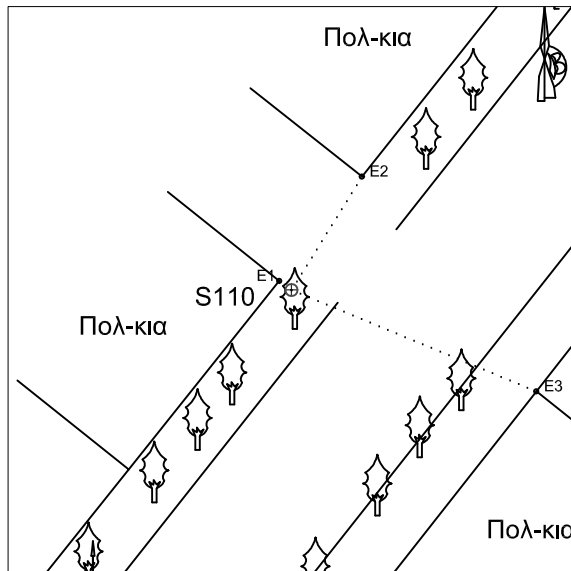

S111
 X=408581.457
 Y=4500756.694
 H= 17.391
 E1= 1.35
 E2= 11.19
 E3= 9.22

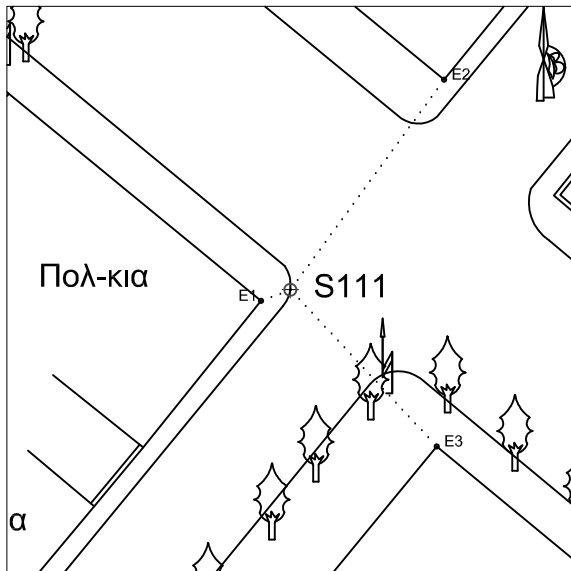

S112
 X= 408591.737
 Y=4500817.194
 H= 17.703
 E1= 13.05
 E2= 0.63
 E3= 13.67

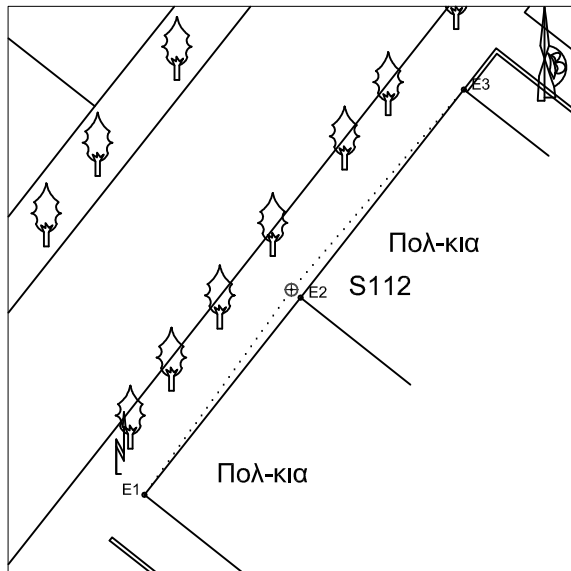

S113
 X= 408487.072
 Y=4500686.168
 H= 16.237
 E1= 13.56
 E2= 3.16
 E3= 13.43

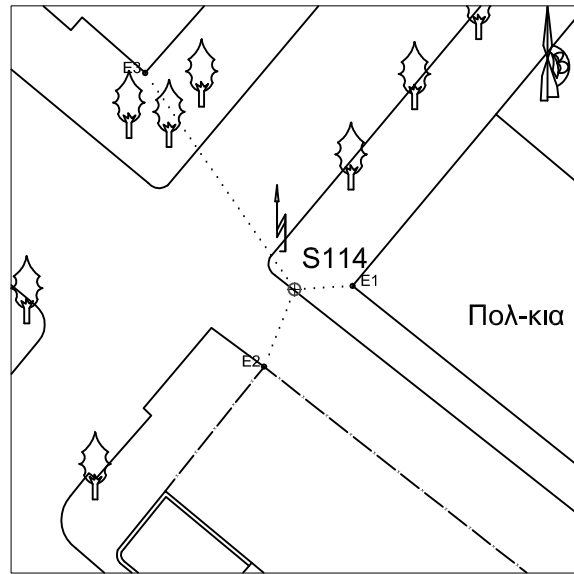
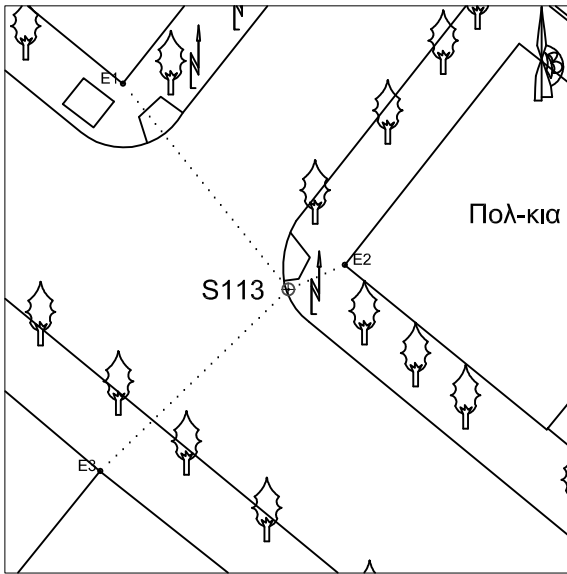

S114
 X= 408625.652
 Y=4500732.104
 H= 17.053
 E1= 2.84
 E2= 4.04
 E3= 12.8

S115
 X= 408544.702
 Y=4500711.811
 H= 16.821
 E1= 4.11
 E2= 12.69
 E3= 6.18

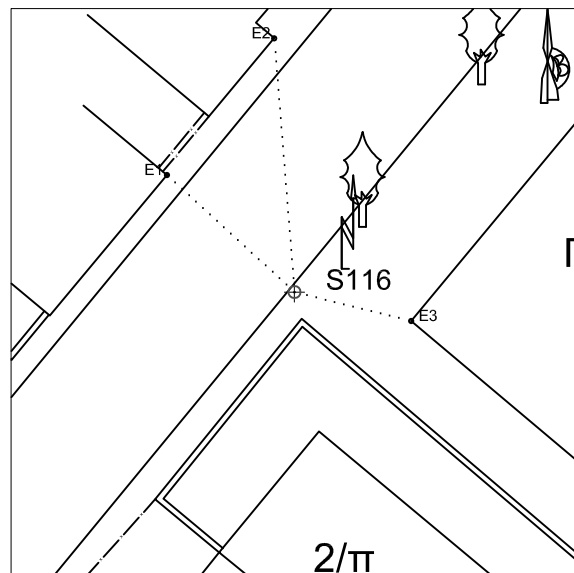
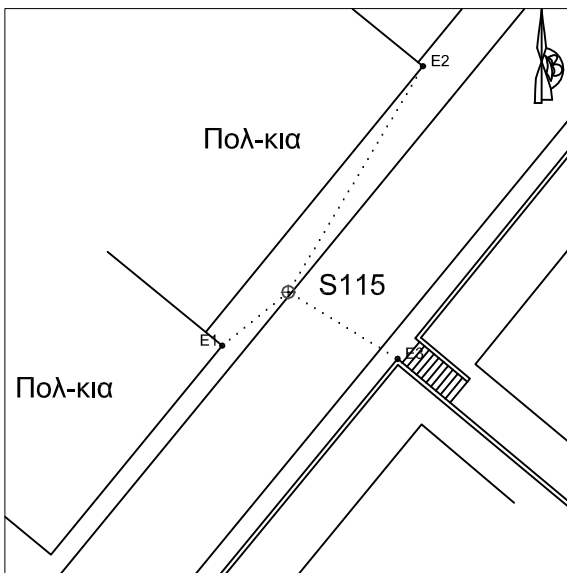

S116
 X= 408629.616
 Y=4500806.689
 H= 17.787
 E1= 5.99
 E2= 8.8
 E3= 4.16

S117
 X= 408516.162
 Y=4500665.665
 H= 16.171
 E1= 8.03
 E2= 12.27
 E3= 2.27

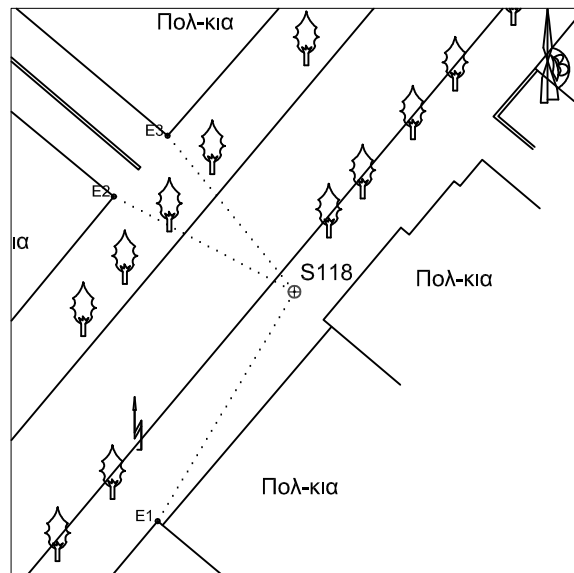
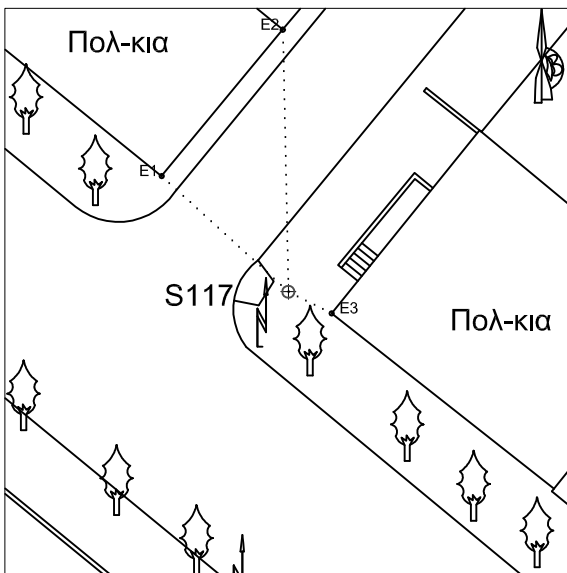

S118
 X= 408663.241
 Y= 4500777.76
 H= 17.553
 E1= 16.28
 E2= 12.44
 E3= 12.26

S119
 X= 408647.961
 Y= 500714.588
 H= 17.302
 E1= 7.22
 E2= 6.93
 E3= 8.98

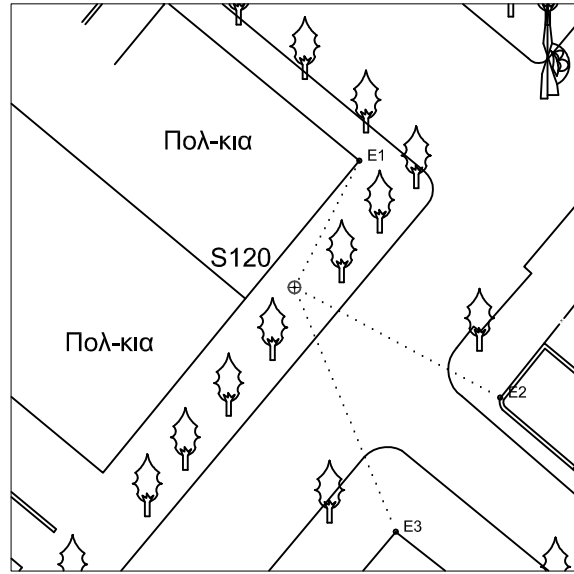
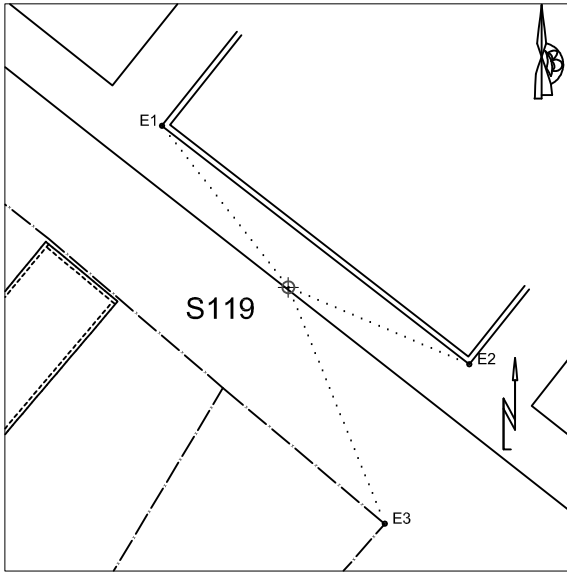

S120
 X= 408606.211
 Y=4500725.227
 H= 16.930
 E1= 7.5
 E2= 12.29
 E3= 13.93

S121
 X= 408639.869
 Y=4500698.306
 H= 17.338
 E1= 2.94
 E2= 10.4
 E3= 8.58

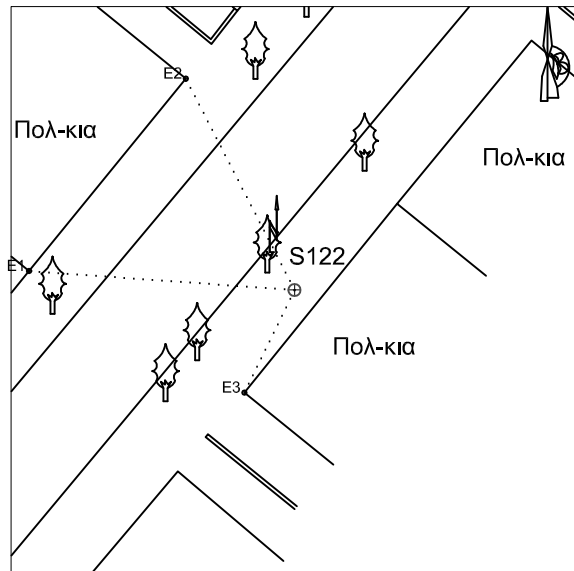
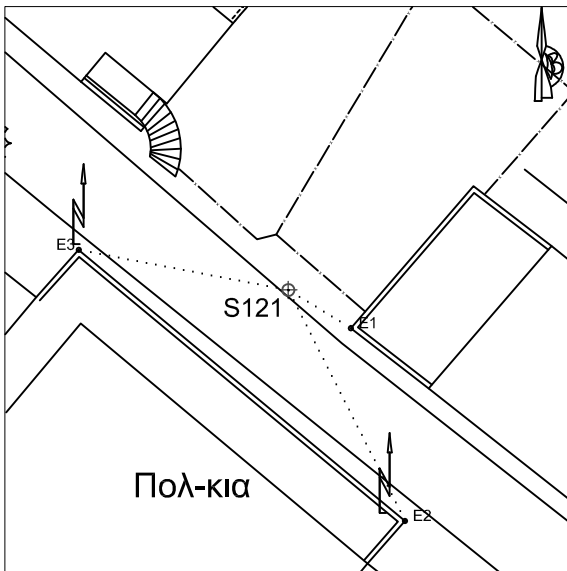

S122
 X= 408578.469
 Y=4500674.498
 H= 16.525
 E1= 15.2
 E2= 13.58
 E3= 6.52

S123
 X= 408548.901
 Y=4500638.492
 H= 16.059
 E1= 12.59
 E2= 1.54
 E3= 15.13

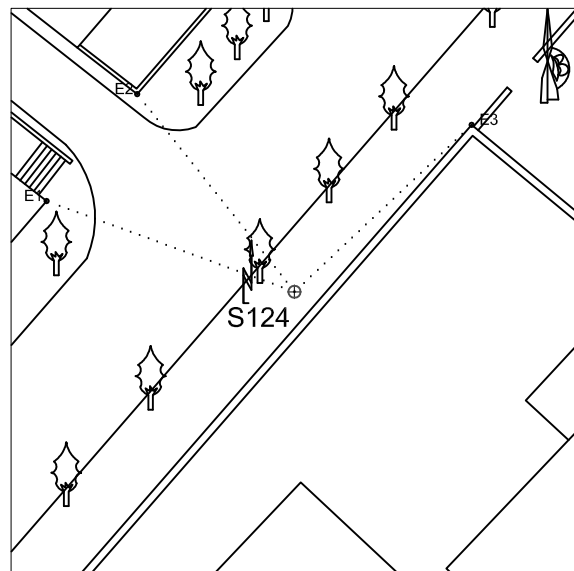
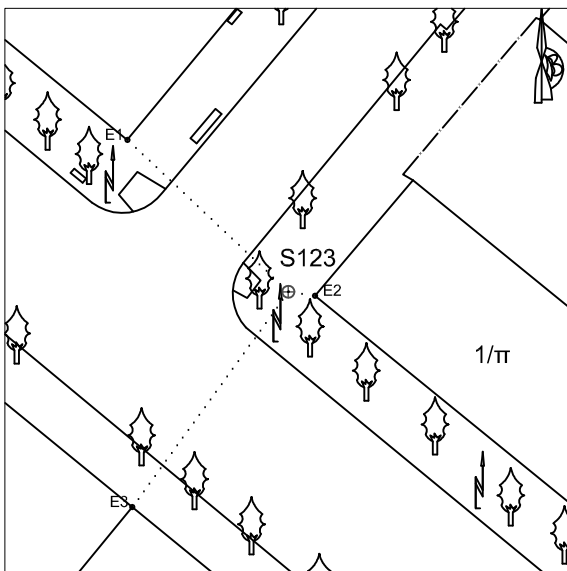

S124
 X= 408675.132
 Y= 4500667.28
 H= 16.979
 E1= 13.56
 E2= 12.97
 E3= 12.5

S125
 X= 408653.037
 Y=4500642.515
 H= 16.658
 E1= 13.72
 E2= 12.25
 E3= 10.21

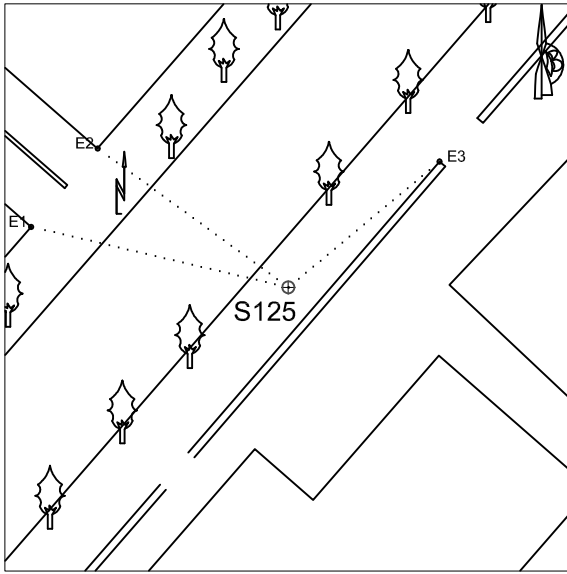

S126
 X= 408710.606
 Y=4500708.075
 H= 17.567
 E1= 16.89
 E2= 16.16
 E3= 13.99

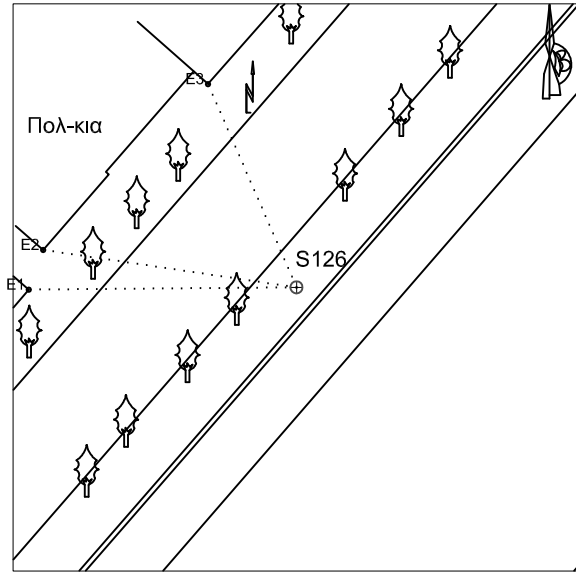

S127
 X= 408607.743
 Y=4500588.985
 H= 16.123
 E1= 15.69
 E2= 13.16
 E3= 1.35

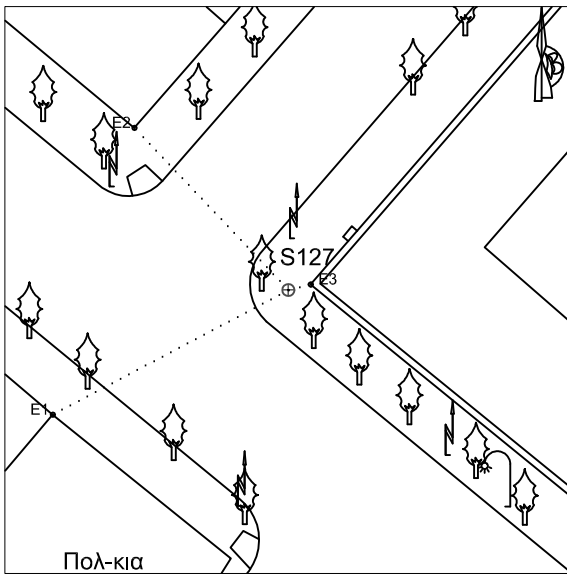

S128
 X= 408729.386
 Y=4500728.384
 H= 17.950
 E1= 1.94
 E2= 13.72
 E3= 3.33

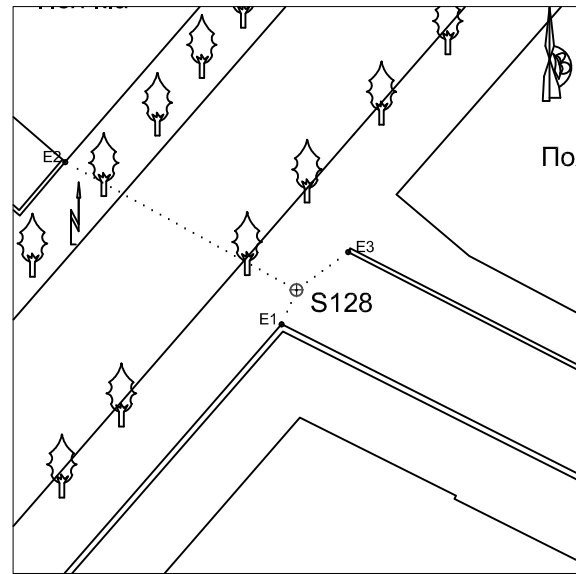

S129
 X= 408782.27
 Y=4500700.815
 H= 18.550
 E1= 10.32
 E2= 17.2
 E3= 23.24

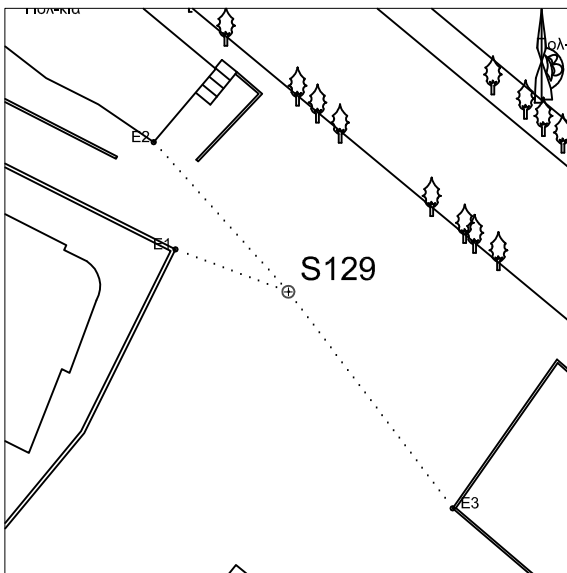

S130
 X= 408747.63
 Y=4500652.389
 H= 18.491
 E1= 10.08
 E2= 8.41
 E3= 11.24

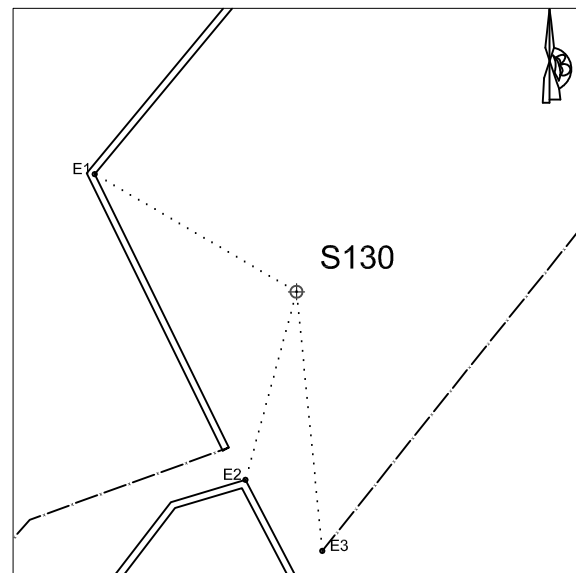

S131
X= 408754.333
Y=4500628.461
H= 18.270
E1= 2.42
E2= 8.43
E3= 3.66

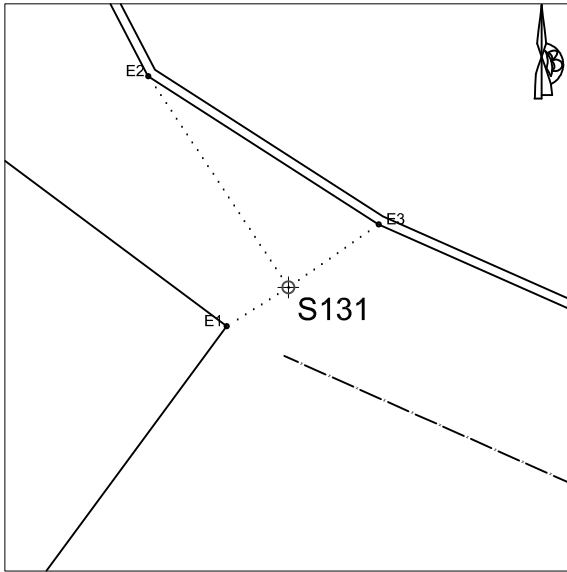

S132
X= 408810.389
Y=4500602.536
H= 17.678
E1= 8.21
E2= 4.62
E3= 12.37

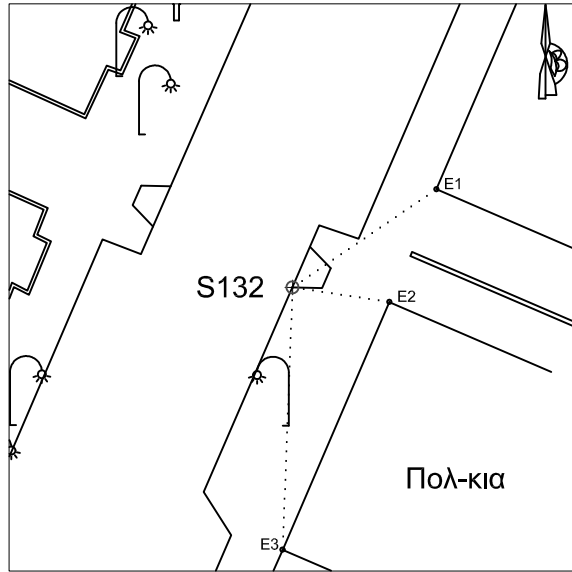

S133
X= 408829.591
Y=4500642.106
H= 18.088
E1= 2.62
E2= 23.17
E3= 14.65

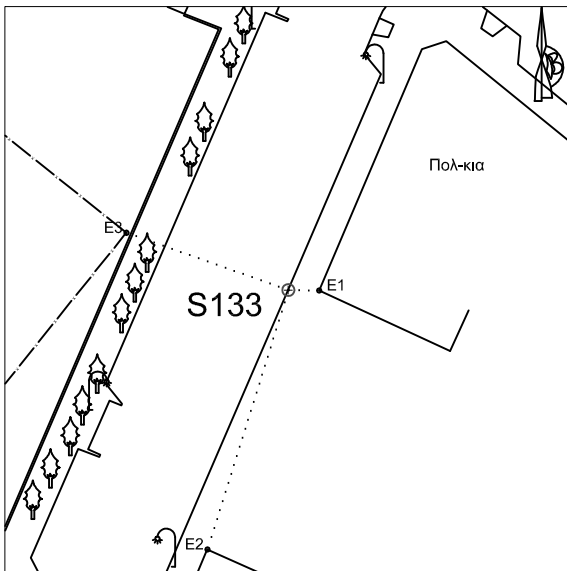

S134
X= 408796.776
Y=4500567.326
H= 17.245
E1= 11.69
E2= 3.07
E3= 17.31

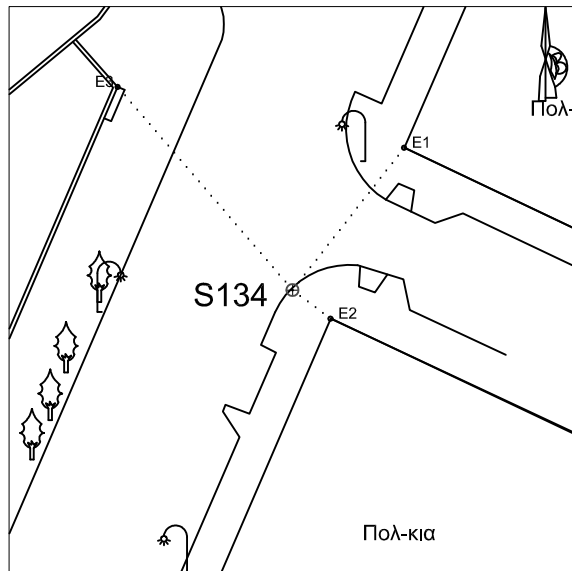

S135
X= 408768.64
Y=4500528.002
H= 16.626
E1= 3.22
E2= 10.02
E3= 13.71

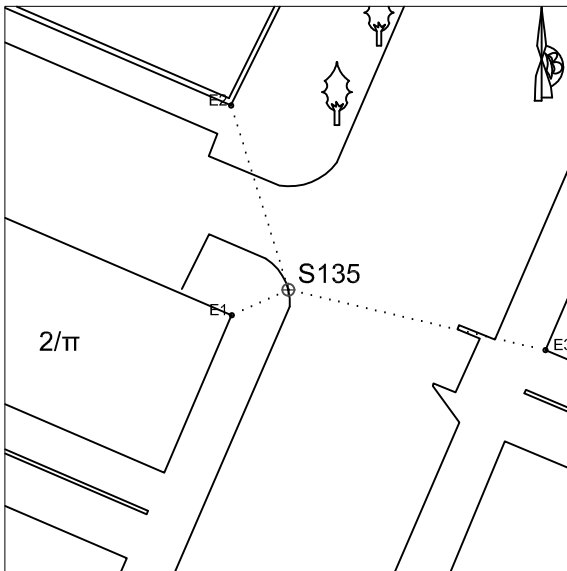

S136
X= 408739.058
Y= 4500547.74
H= 16.610
E1= 1.83
E2= 9.77
E3= 15.63

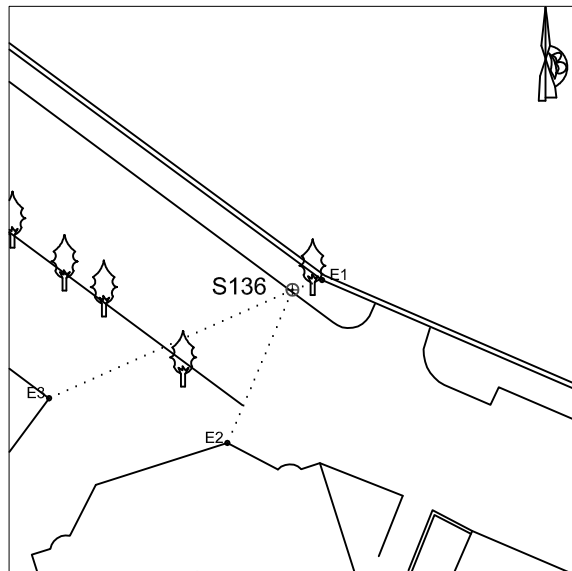

S137
 X= 408753.332
 Y=4500474.704
 H= 16.118
 E1= 4.48
 E2= 8.04
 E3= 20.92

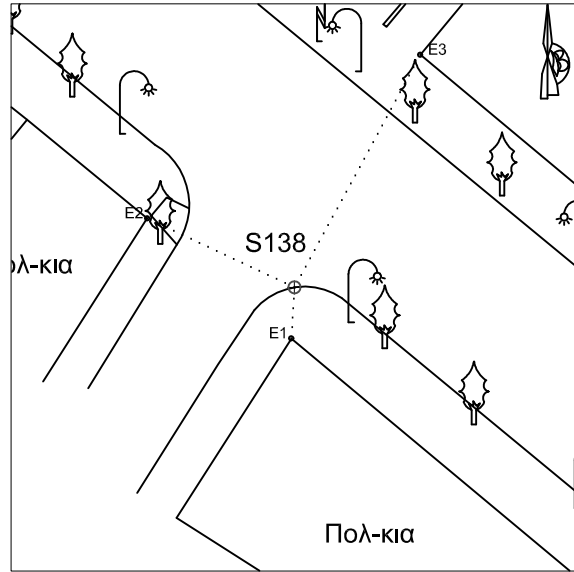
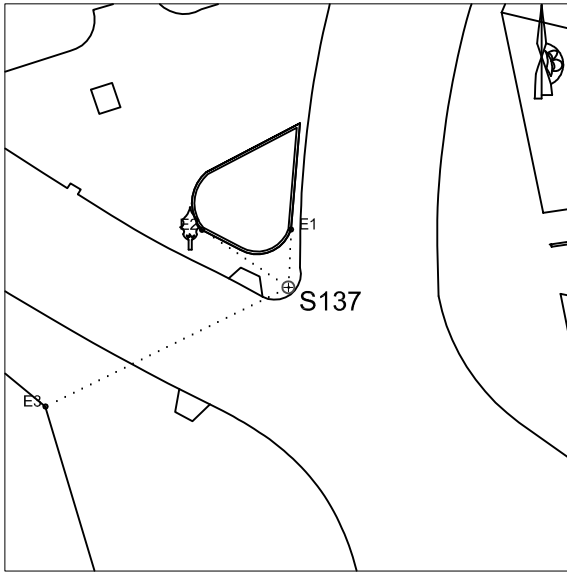

S138
 X= 408701.117
 Y=4500496.069
 H= 15.933
 E1= 2.66
 E2= 8.47
 E3= 13.77

S139
 X= 408661.9
 Y=4500542.926
 H= 15.859
 E1= 16.75
 E2= 13.3
 E3= 10.71

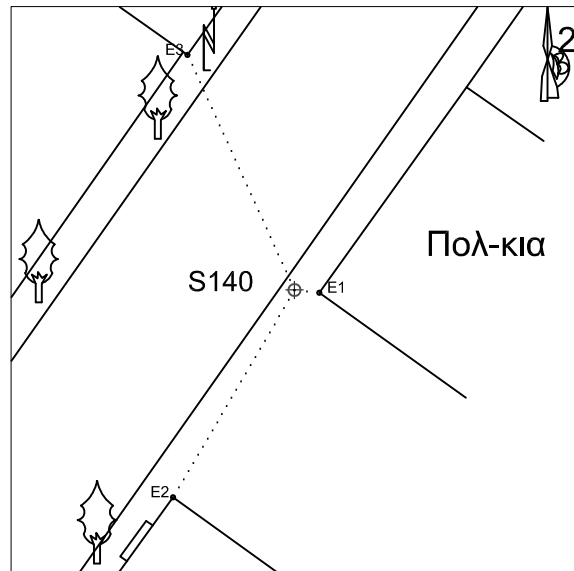
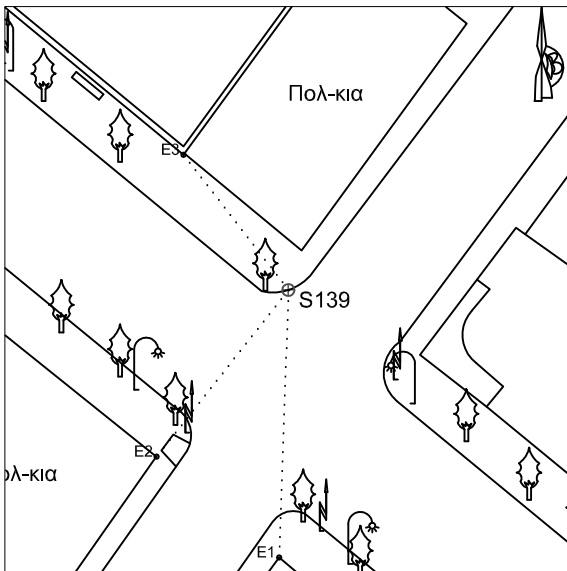

S140
 X= 408639.883
 Y=4500497.519
 H= 15.063
 E1= 0.99
 E2= 9.5
 E3= 10.22

S141
 X= 408690.615
 Y=4500582.869
 H= 16.334
 E1= 2.29
 E2= 5.16
 E3= 13.6

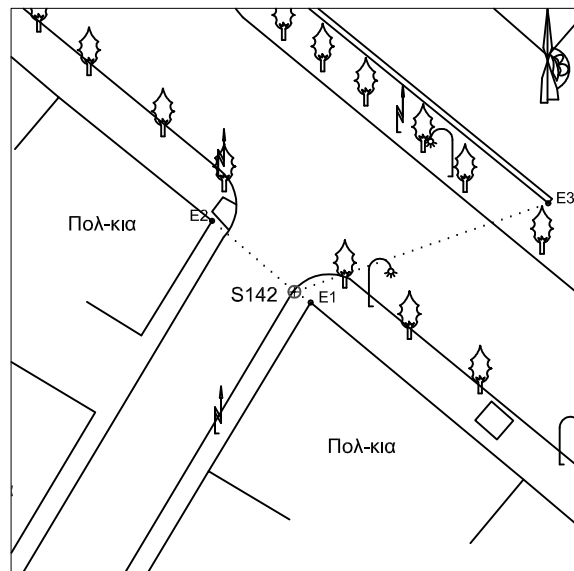
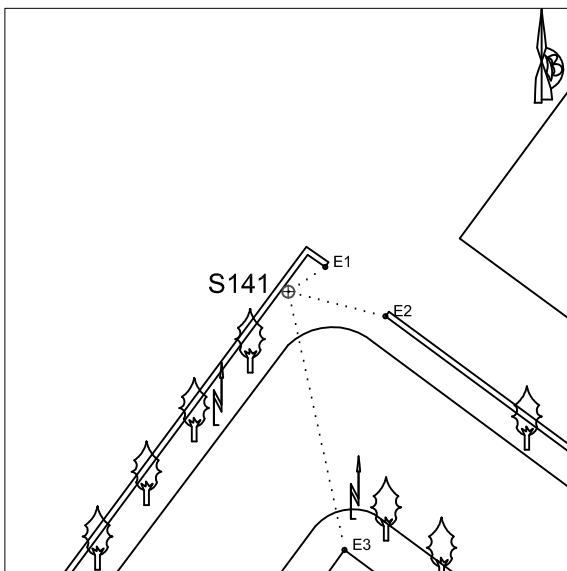

S142
 X= 408609.992
 Y= 4500568.35
 H= 15.901
 E1= 1.33
 E2= 7.43
 E3= 18.4

S139A
 X= 408642.488
 Y=4500560.833
 H= 16.046
 E1= 13.32
 E2= 15.94
 E3= 18.24

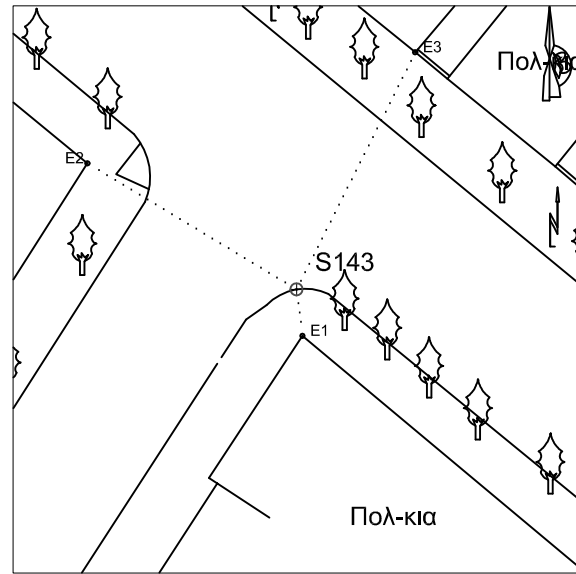
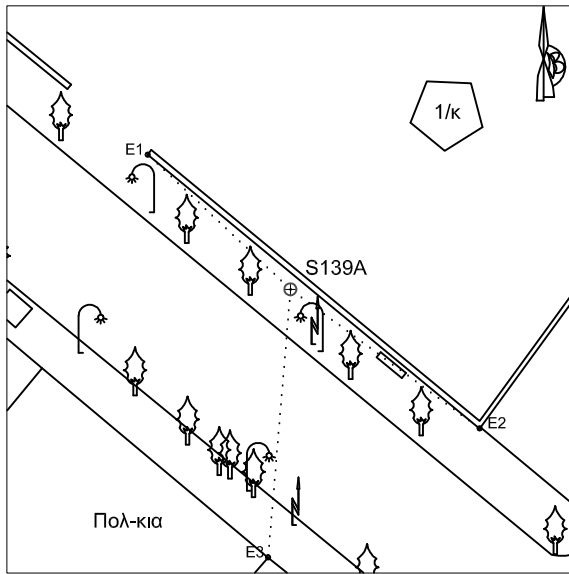

S143
 X= 408560.925
 Y=4500611.582
 H= 15.851
 E1= 2.54
 E2= 13.26
 E3= 14.41

S144
 X= 408534.792
 Y=4500571.206
 H= 15.190
 E1= 9.92
 E2= 15.36
 E3= 13.58

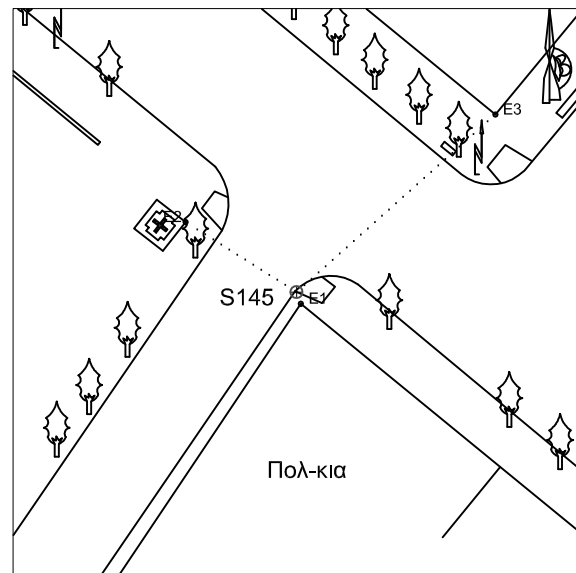
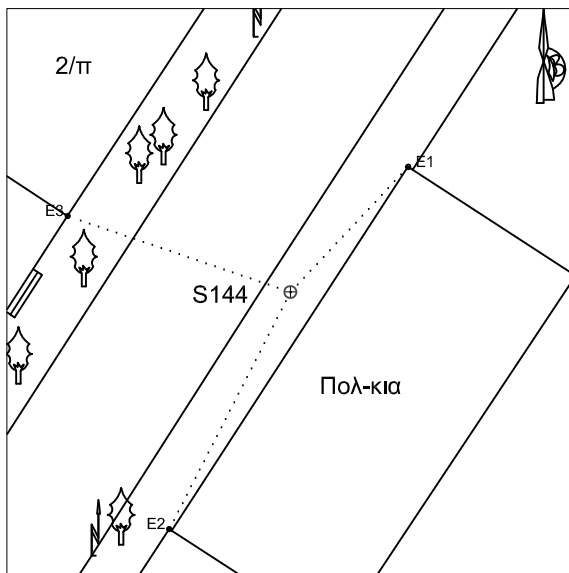

S145
 X= 408527.953
 Y=4500636.605
 H= 15.945
 E1= 0.75
 E2= 7.76
 E3= 15.8

S146
 X= 408484.838
 Y=4500583.969
 H= 15.391
 E1= 1.38
 E2= 14.48
 E3= 13.36

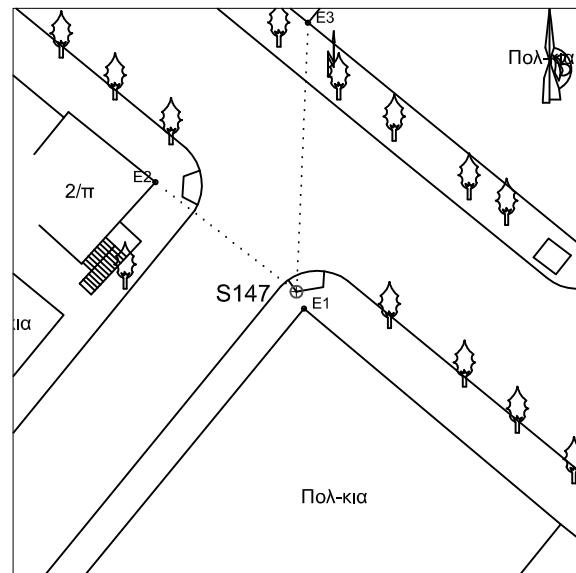
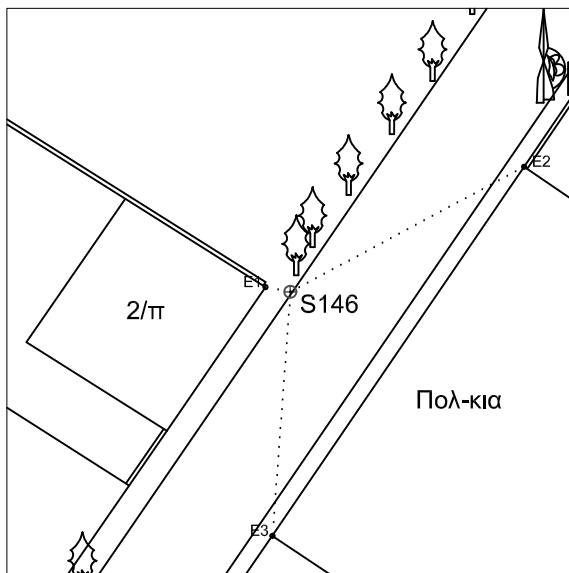

S147
 X= 408458.761
 Y=4500693.255
 H= 16.343
 E1= 1.31
 E2= 12.61
 E3= 19.01

S148
 X= 408425.393
 Y=4500721.557
 H= 16.503
 E1= 7.11
 E2= 6.77
 E3= 13.55

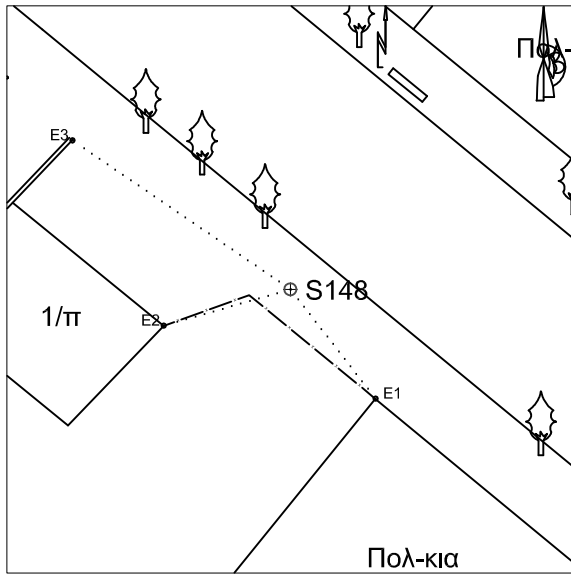

S149
 X= 408416.58
 Y=4500656.912
 H= 15.445
 E1= 2.68
 E2= 10.63
 E3= 14.42

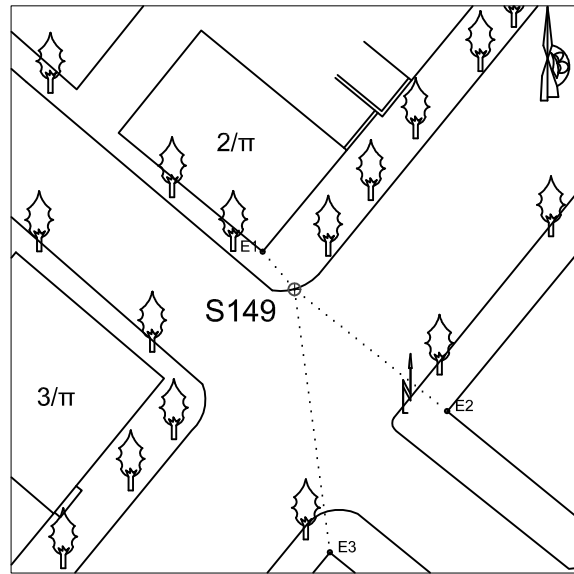

S150
 X= 408468.349
 Y=4500612.399
 H= 15.739
 E1= 1.42
 E2= 4.87
 E3= 24.53

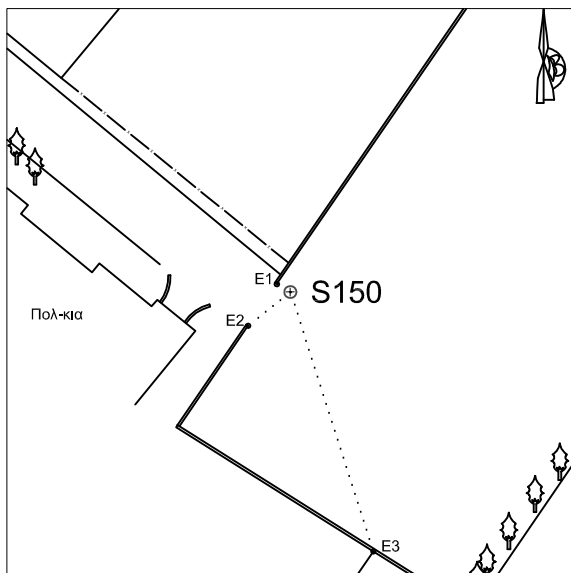

S151
 X= 408391.142
 Y=4500610.379
 H= 14.825
 E1= 9.76
 E2= 9.5
 E3= 12.71

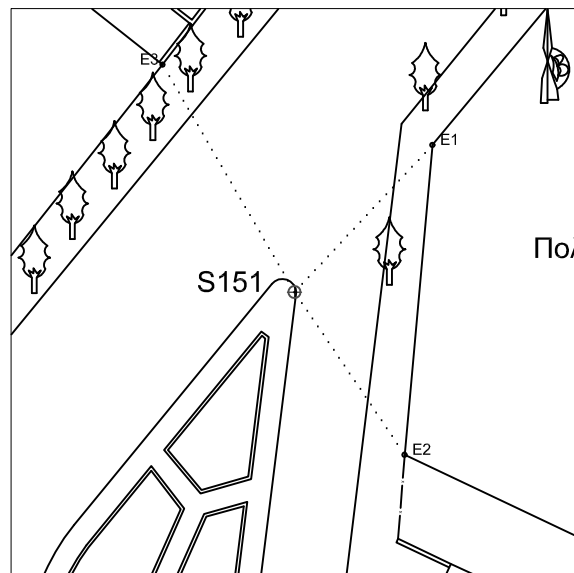

S152
 X= 408369.695
 Y=4500687.506
 H= 15.223
 E1= 2.49
 E2= 8.39
 E3= 7.9

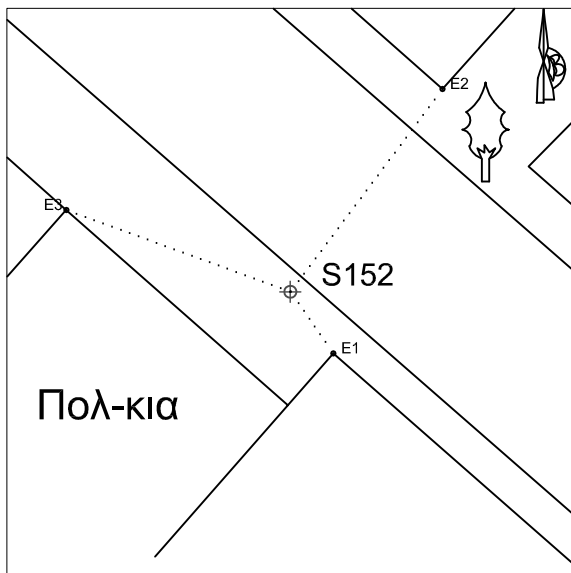

S153
 X= 408460.619
 Y=4500540.274
 H= 14.958
 E1= 1.2
 E2= 4.46
 E3= 9.67

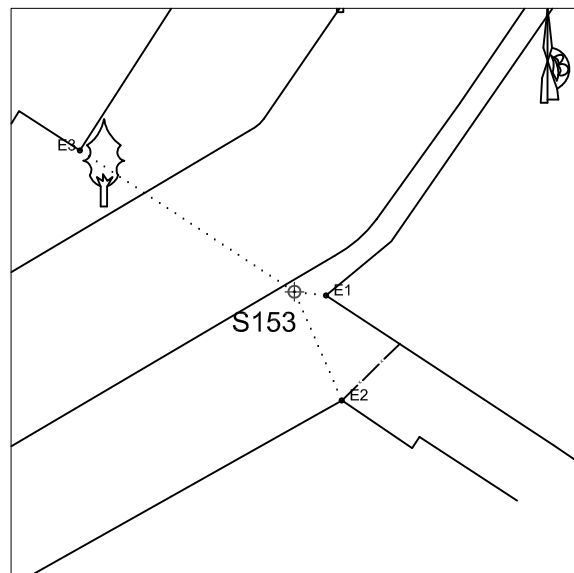

S154
X=408418.544
Y=4500522.711
H= 14.622
E1= 2.15
E2= 7.21
E3= 12.88

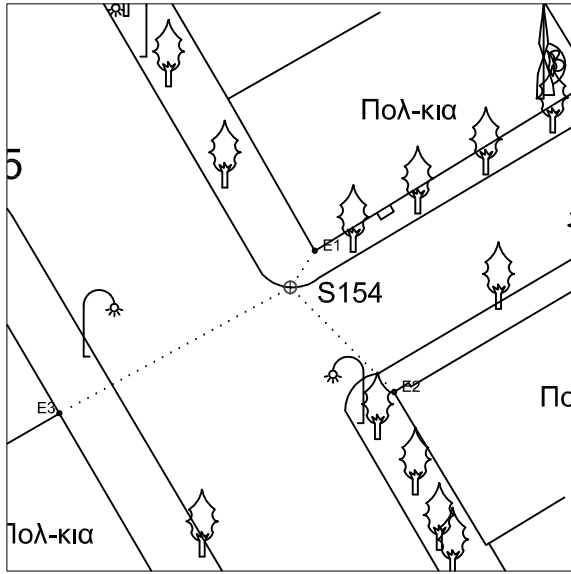

S155
X= 408403.596
Y=4500526.236
H= 14.527
E1= 13.2
E2= 22.06
E3= 2.21

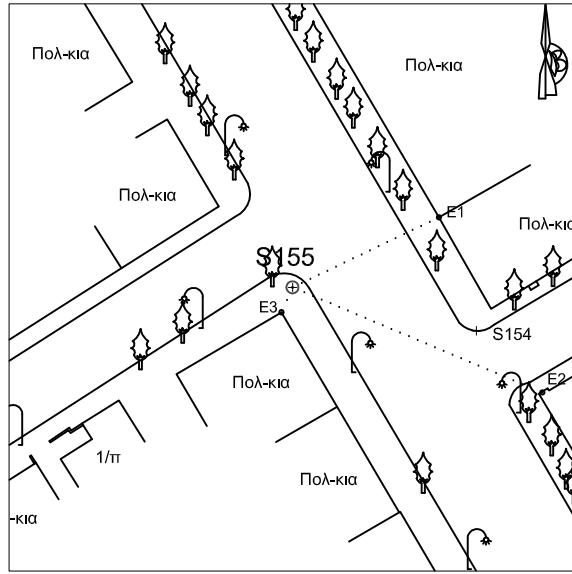

S156
X= 408429.726
Y=4500480.916
H= 14.376
E1= 2.24
E2= 14.25
E3= 16.18

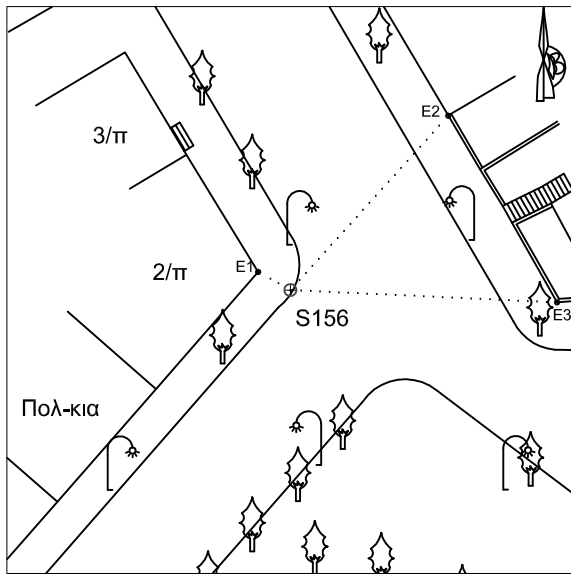

S157
X= 408339.362
Y=4500493.923
H= 14.021
E1= 12.51
E2= 13.38
E3= 4.91

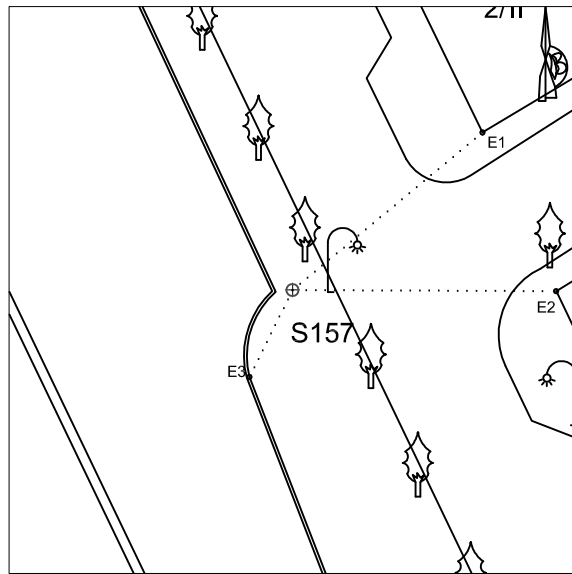

S158
X= 408386.484
Y=4500576.24
H= 14.448
E1= 9.89
E2= 11.83
E3= 14.93

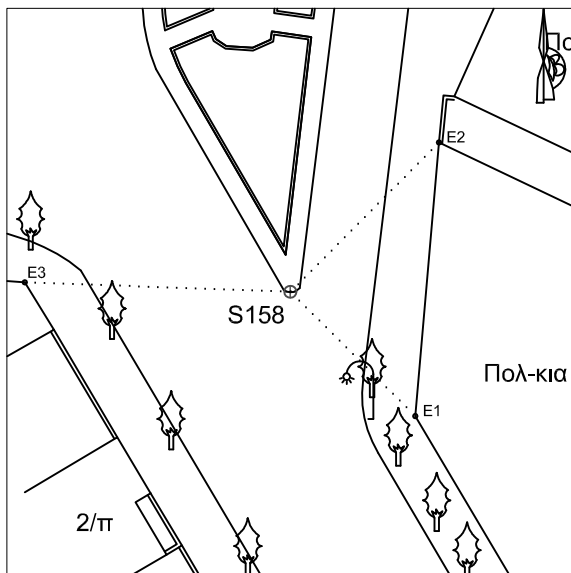

S159
X= 408464.596
Y=4500463.041
H= 14.283
E1= 4.18
E2= 13.42
E3= 6.77

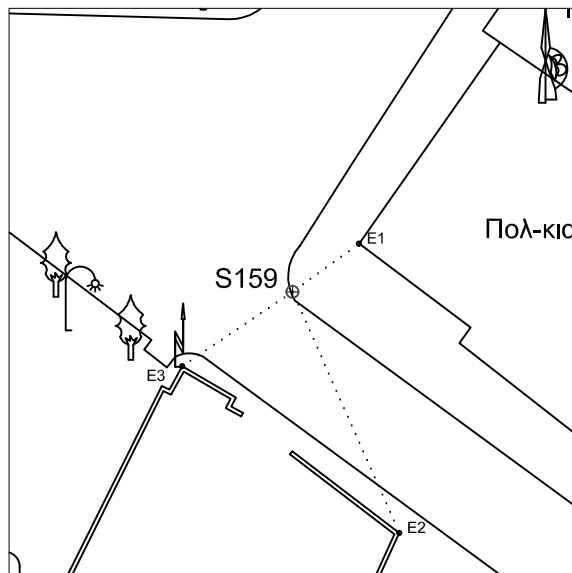

S160
 X= 408370.399
 Y=4500407.183
 H= 13.535
 E1= 30.47
 E2= 17.29
 E3= 13.79

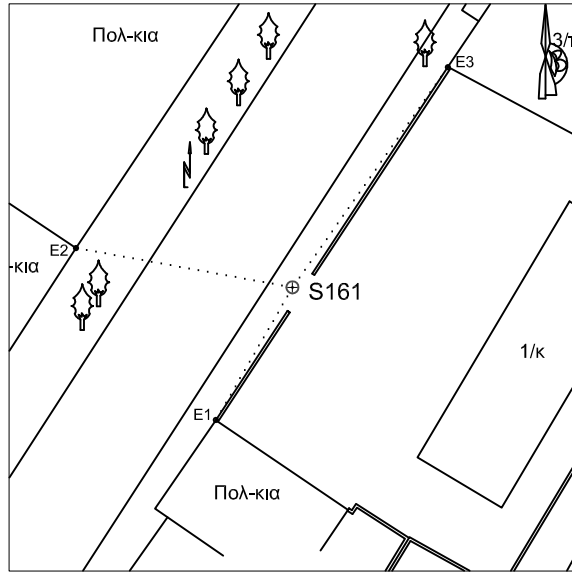
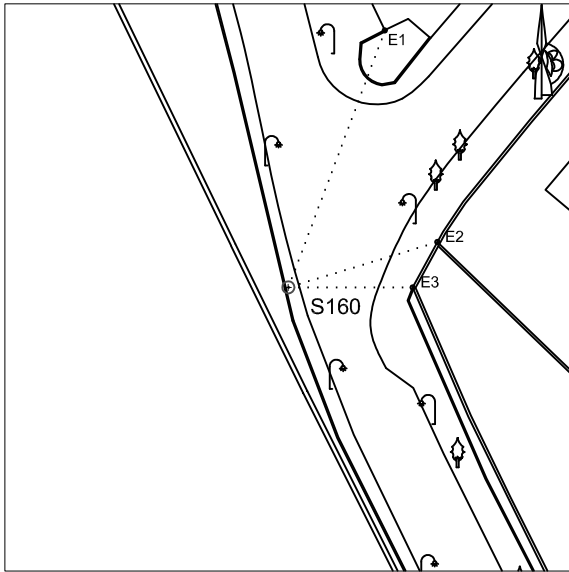

S161
 X= 408484.105
 Y=4500492.132
 H= 14.296
 E1= 10.95
 E2= 15.74
 E3= 19.28

S163
 X= 408494.444
 Y=4500531.279
 H= 14.617
 E1= 10.82
 E2= 8.38
 E3= 15.17

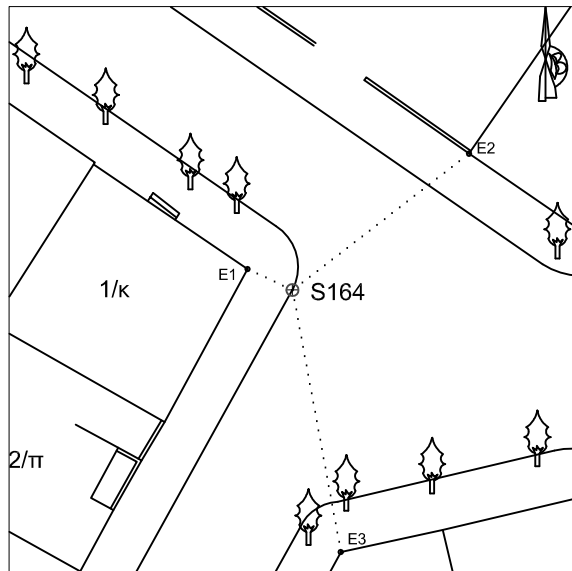
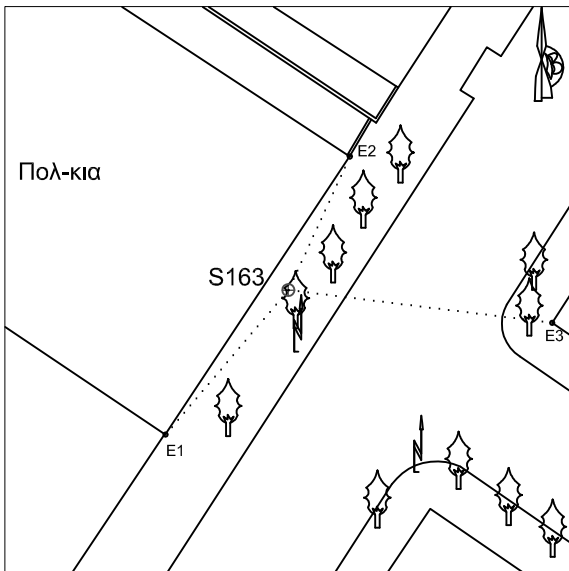

S164
 X= 408532.445
 Y= 4500498.69
 H= 14.363
 E1= 2.91
 E2= 13.08
 E3= 15.62

S165
 X= 408555.145
 Y=4500485.876
 H= 14.463
 E1= 5.65
 E2= 16.69
 E3= 14.47

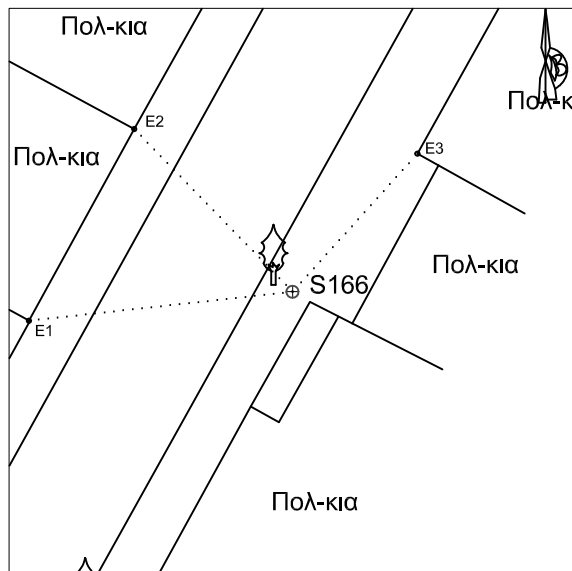
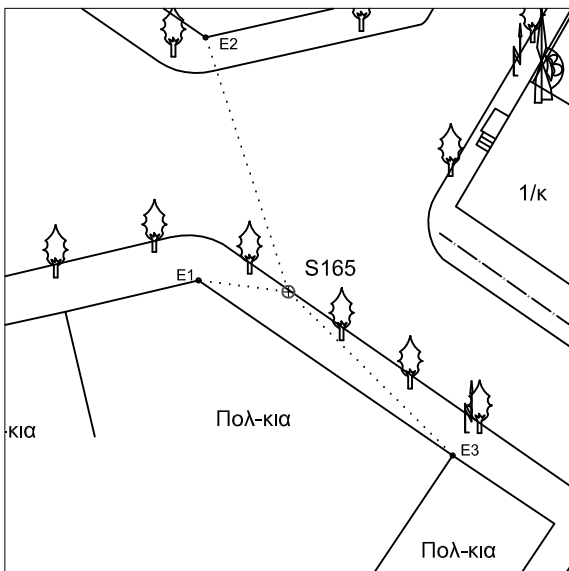

S166
 X= 408518.819
 Y=4500455.841
 H= 14.074
 E1= 14.4
 E2= 12.33
 E3= 10.12

S167
 X= 408495.229
 Y=4500432.364
 H= 13.729
 E1= 3.19
 E2= 8.76
 E3= 12.2

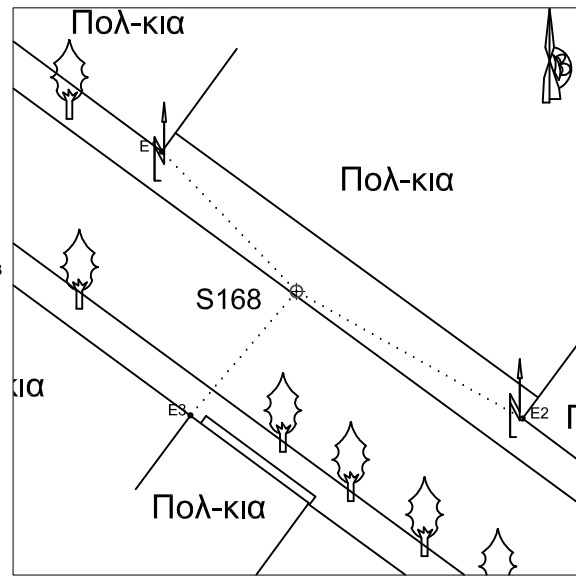
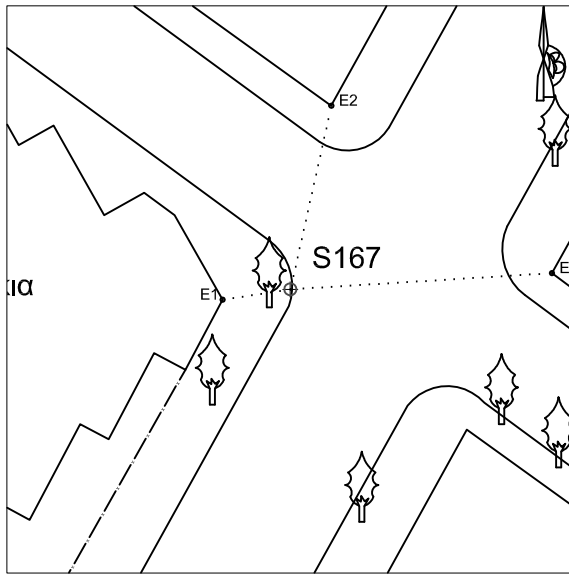

S168
 X= 408528.151
 Y=4500416.169
 H= 13.465
 E1= 8.03
 E2= 10.73
 E3= 6.75

S169
 X= 408483.33
 Y=4500397.708
 H= 13.793
 E1= 8.76
 E2= 8.19
 E3= 17.42

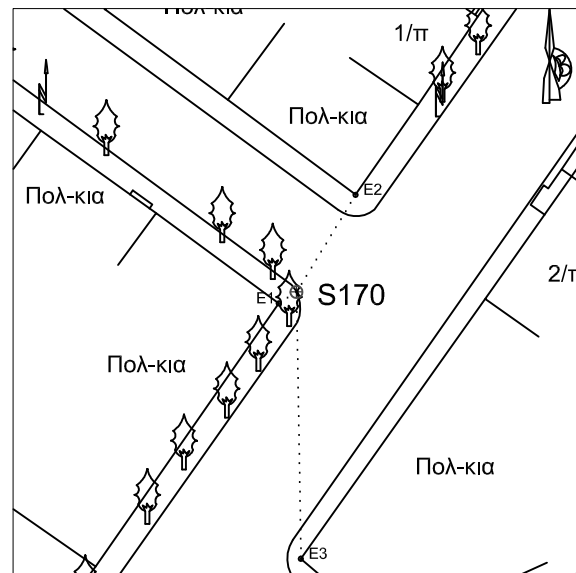
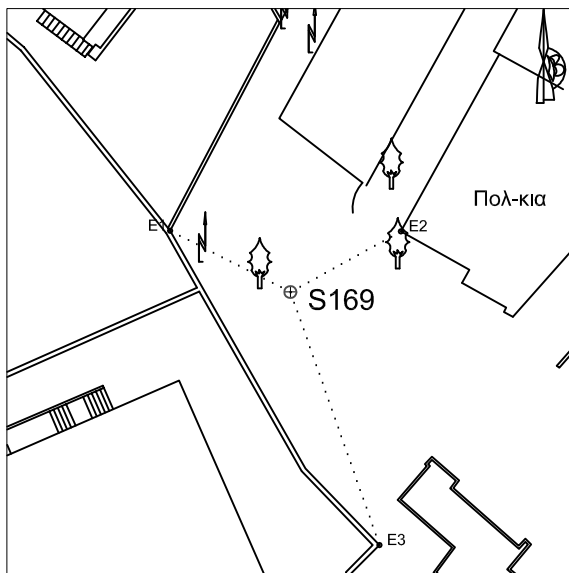

S170
 X= 408553.901
 Y=4500390.408
 H= 13.226
 E1= 1.25
 E2= 6.75
 E3= 15.8

S171
 X= 408586.433
 Y=4500421.526
 H= 13.916
 E1= 12.41
 E2= 9.55
 E3= 9.86

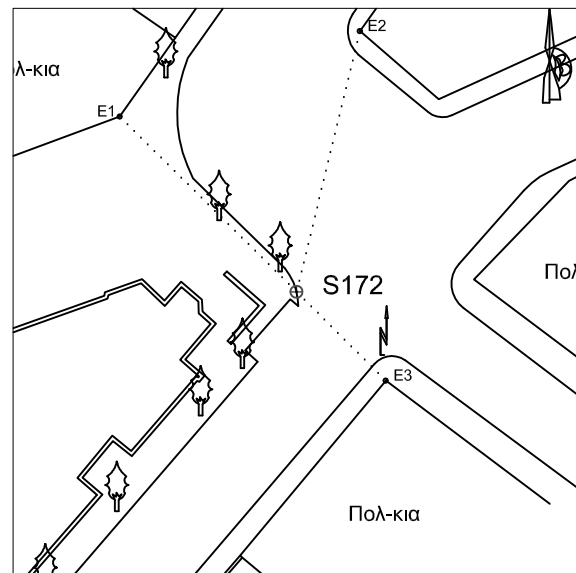
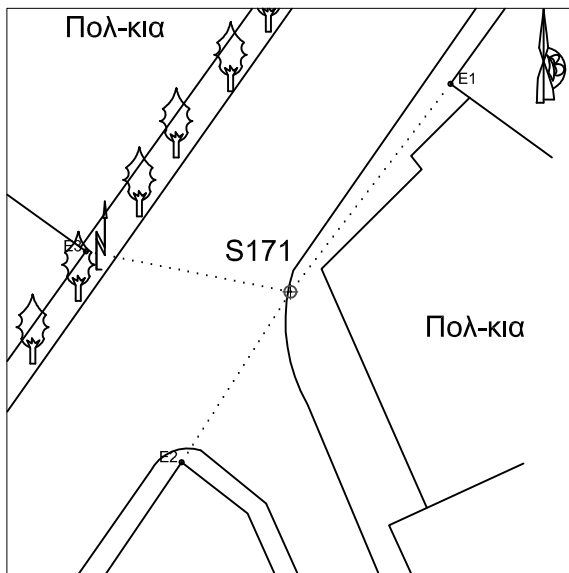

S172
 X= 408549.982
 Y=4500357.422
 H= 13.102
 E1= 16.41
 E2= 17.69
 E3= 8.31

S173
 X= 408605.27
 Y=4500461.705
 H= 14.563
 E1= 2.3
 E2= 8.59
 E3= 10.97

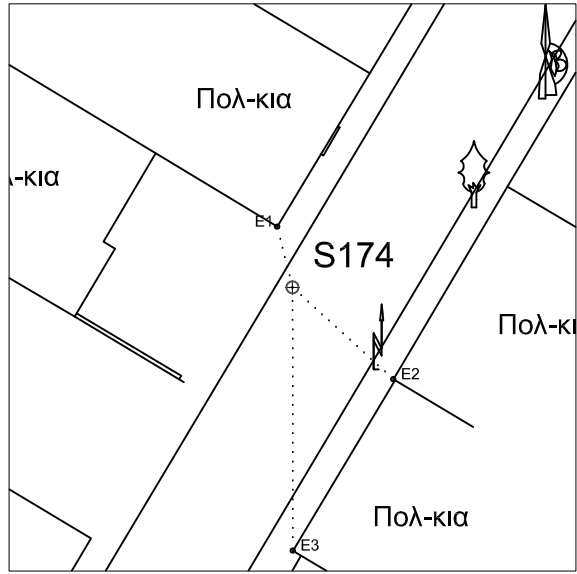
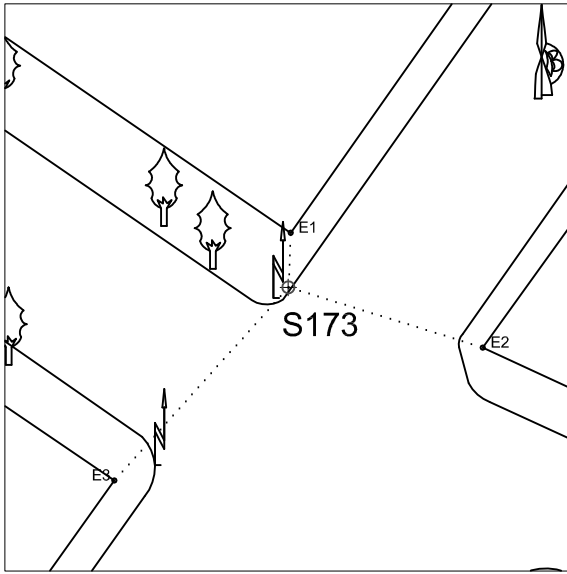

S174
 X= 408583.696
 Y=4500534.751
 H= 15.134
 E1= 3.09
 E2= 6.74
 E3= 13.02

S175
 X= 408502.562
 Y=4500352.597
 H= 13.011
 E1= 3.36
 E2= 6.38
 E3= 5.46

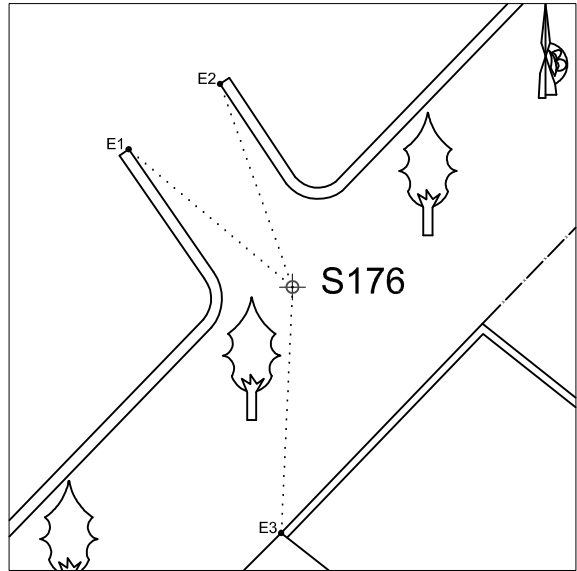
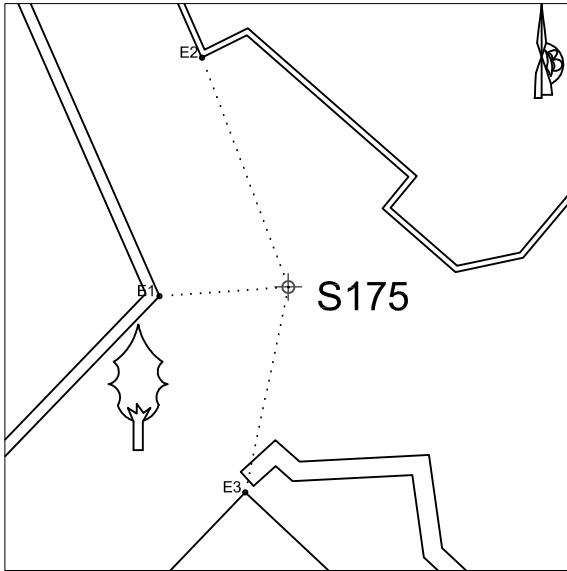

S176
 X= 408480.816
 Y=4500332.106
 H= 12.901
 E1= 5.71
 E2= 5.75
 E3= 6.57

S177
 X= 408531.051
 Y=4500321.268
 H= 12.412
 E1= 8.42
 E2= 8.22
 E3= 1.86

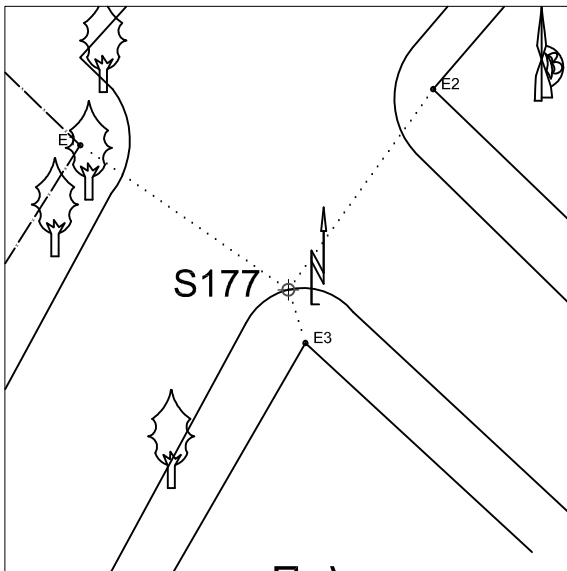

S178
 X= 408502.944
 Y=4500286.109
 H= 11.995
 E1= 2.45
 E2= 8.7
 E3= 12.61

S179
 X= 408455.381
 Y=4500303.744
 H= 12.489
 E1= 32.06
 E2= 17.39
 E3= 18.36

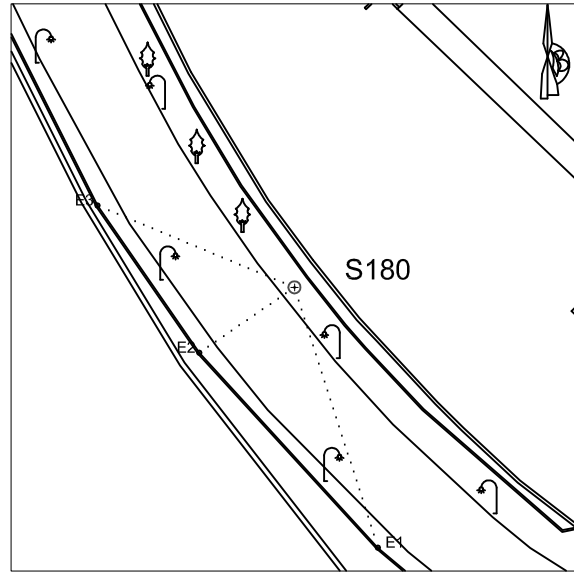
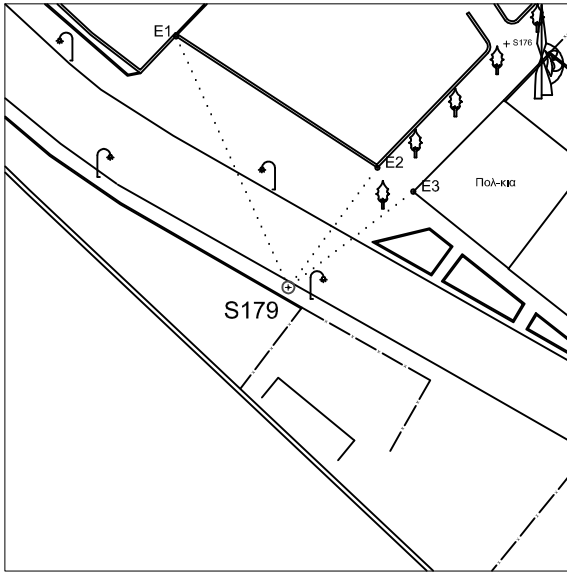

S180
 X= 408410.464
 Y=4500352.283
 H= 13.028
 E1= 26.75
 E2= 11.3
 E3= 20.88

S181
 X= 408330.891
 Y=4500538.764
 H= 14.179
 E1= 15.93
 E2= 16.61
 E3= 15.25

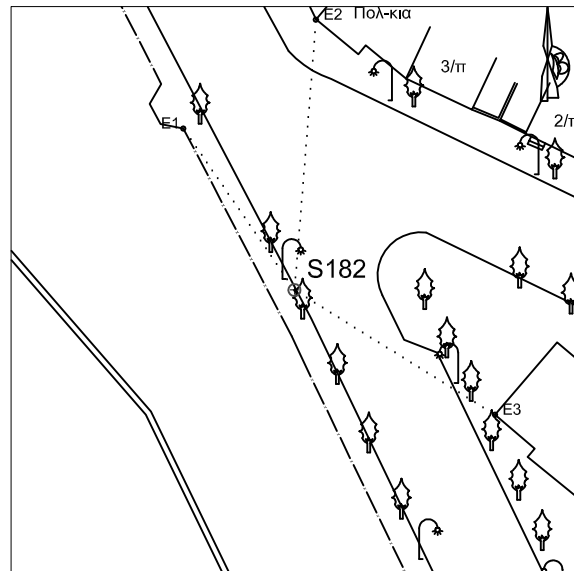
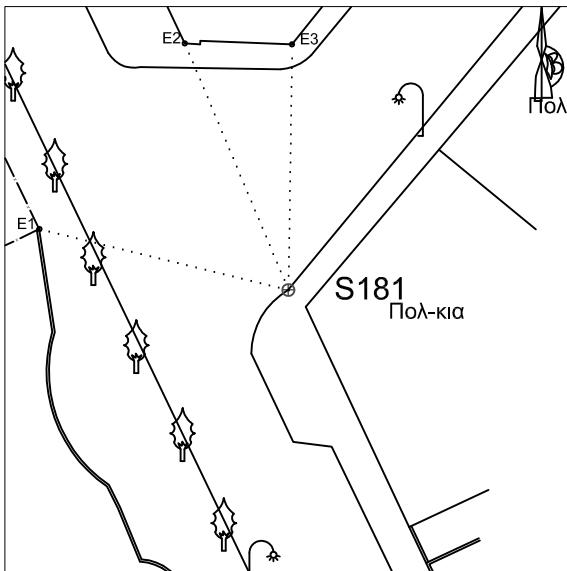

S182
 X= 408273.543
 Y= 4500634.97
 H= 14.237
 E1= 16
 E2= 22.15
 E3= 19.29

S183
 X= 408371.525
 Y=4500603.573
 H= 14.502
 E1= 6.59
 E2= 4.12
 E3= 18.49

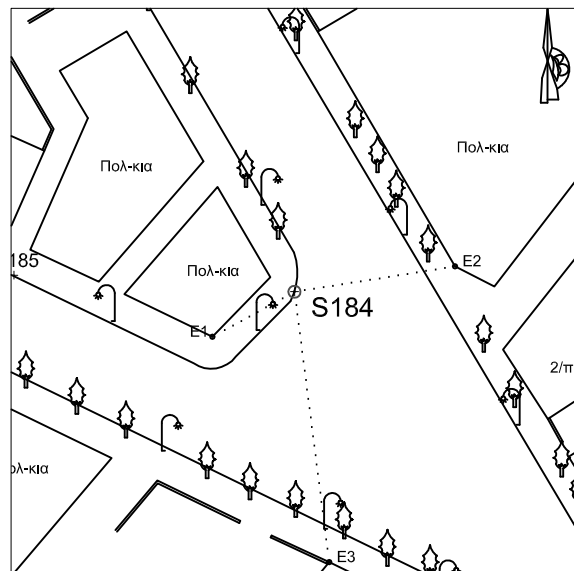
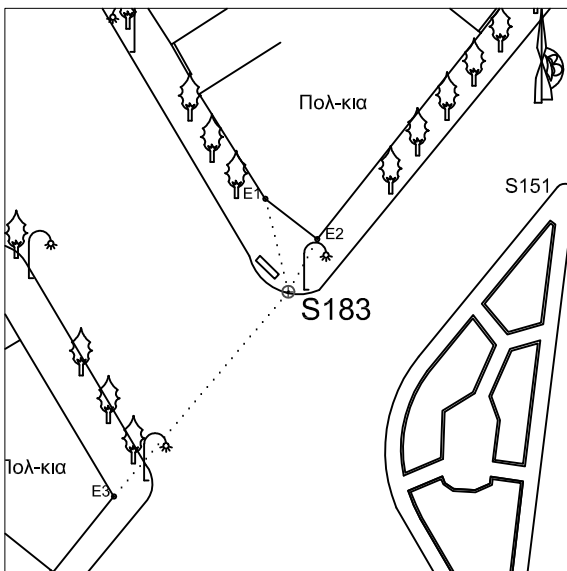

S184
 X= 408340.54
 Y=4500632.106
 H= 14.644
 E1= 8.47
 E2= 14.73
 E3= 24.7

S185
 X= 408315.12
 Y=4500633.613
 H= 14.478
 E1= 18.79
 E2= 11.5
 E3= 17.94

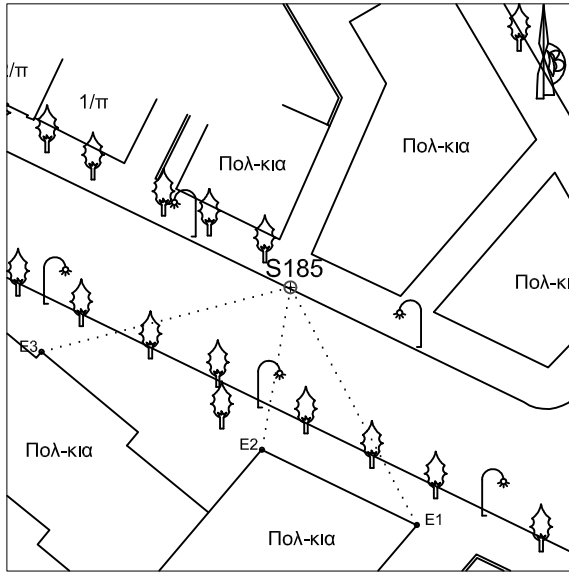

S186
 X= 408319.287
 Y=4500692.316
 H= 14.853
 E1= 12.38
 E2= 13.38
 E3= 16.09

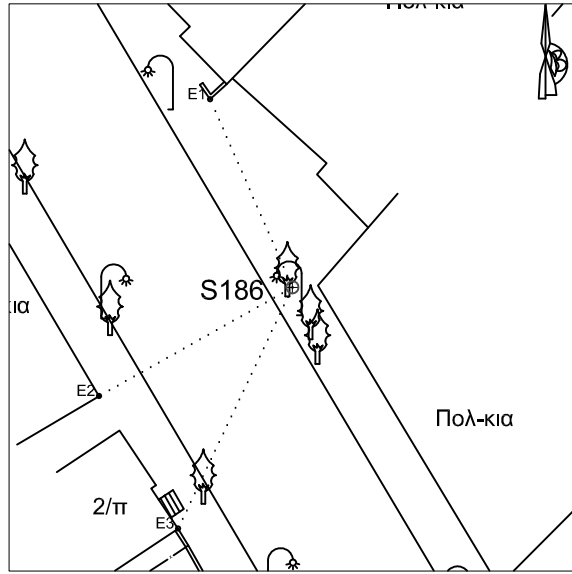

S187
 X= 408258.65
 Y=4500689.588
 H= 14.319
 E1= 9.87
 E2= 7.06
 E3= 17.32

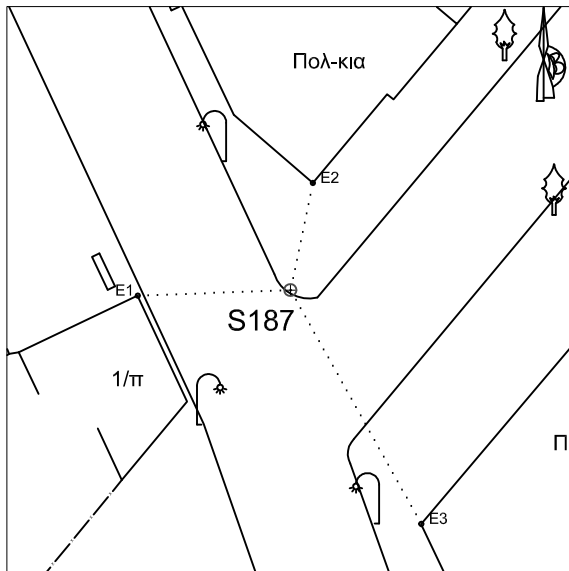

S188
 X= 408287.691
 Y=4500723.319
 H= 14.726
 E1= 2.09
 E2= 16.03
 E3= 13.9

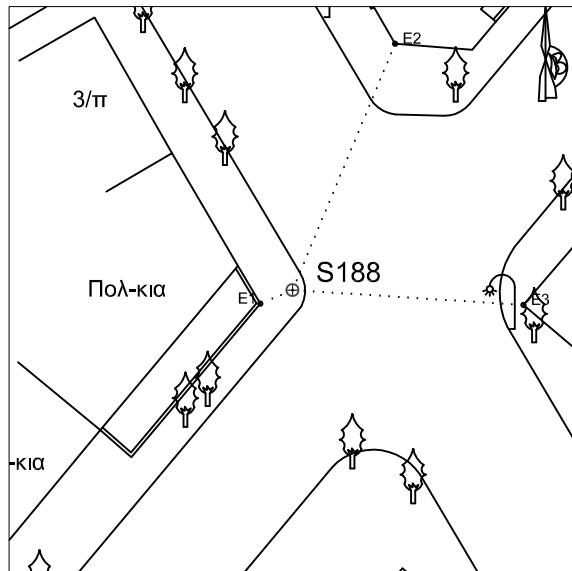

S189
 X= 408226.821
 Y=4500718.857
 H= 14.358
 E1= 15.14
 E2= 14.69
 E3= 18.92

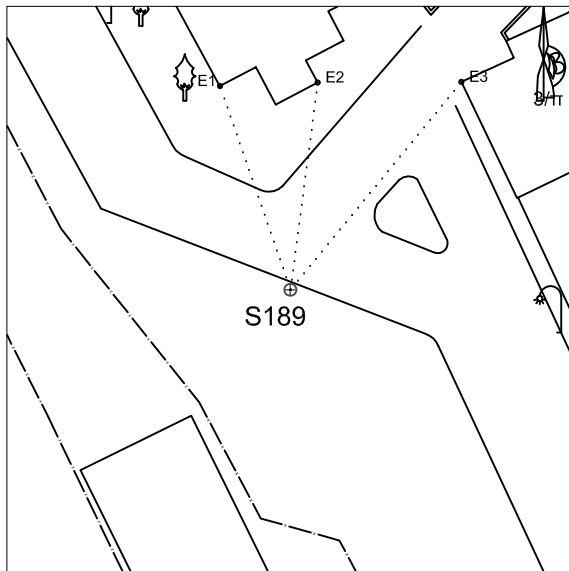

S190
 X= 408312.072
 Y=4500737.806
 H= 15.013
 E1= 2.41
 E2= 13.59
 E3= 10.32

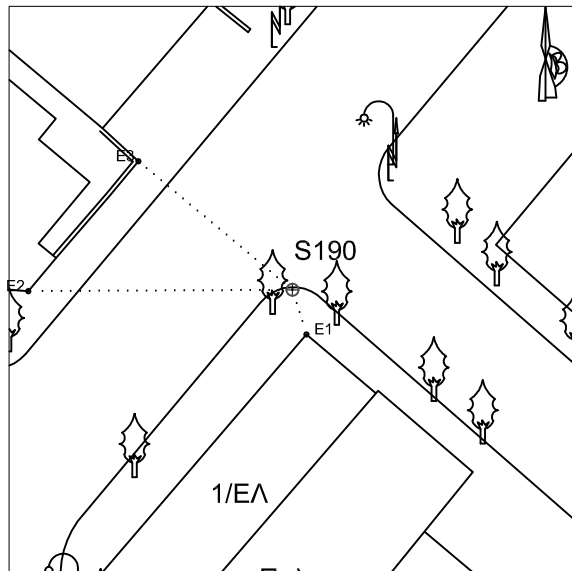

S191
 X= 408268.586
 Y=4500766.134
 H= 14.635
 E1= 12.24
 E2= 11.25
 E3= 6.73

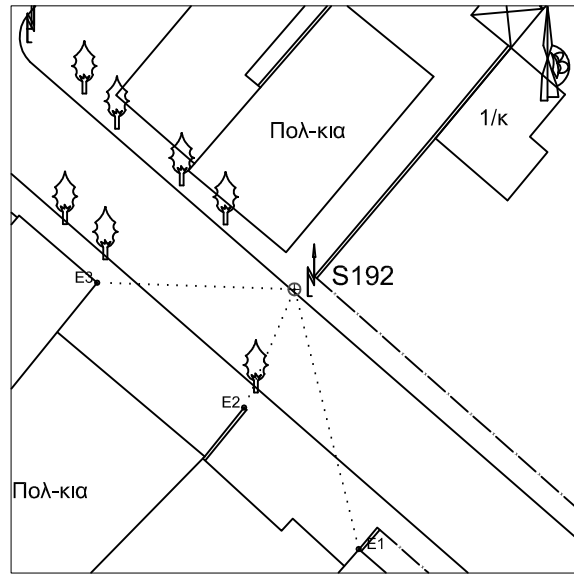
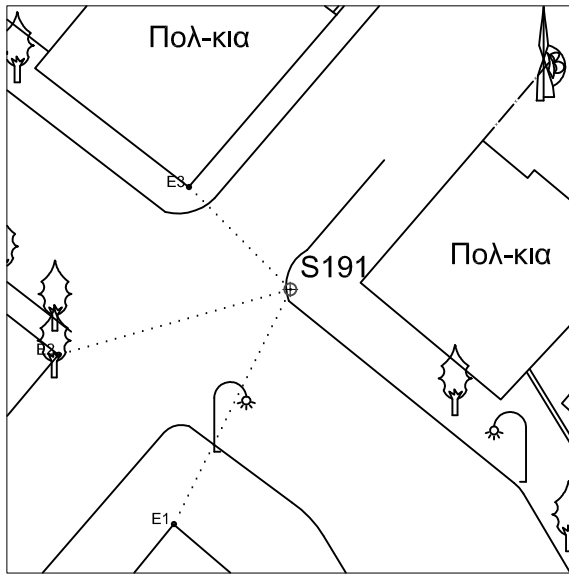

S192
 X= 408333.655
 Y=4500728.014
 H= 15.081
 E1= 16.69
 E2= 8.01
 E3= 12.31

S193
 X= 408226.974
 Y=4500786.965
 H= 14.515
 E1= 7.13
 E2= 12.95
 E3= 9.33

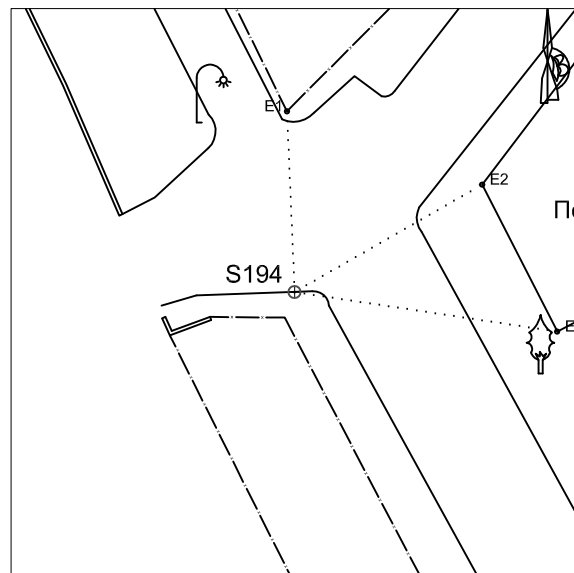
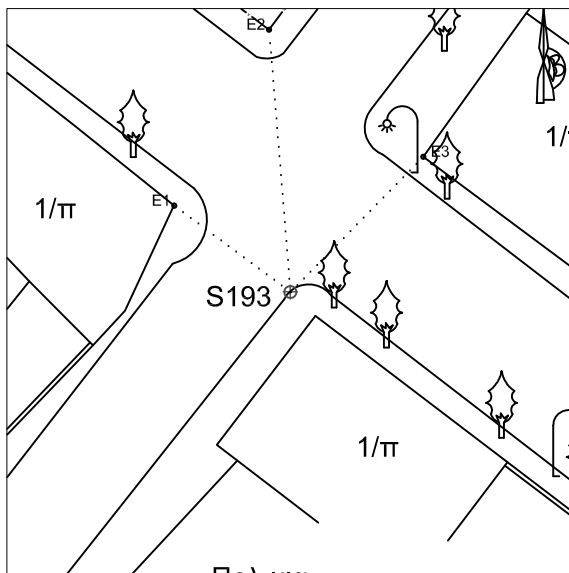

S194
 X= 408196.577
 Y=4500752.614
 H= 14.459
 E1= 10.16
 E2= 12.14
 E3= 14.92

S195
 X= 408199.556
 Y=4500818.495
 H= 14.713
 E1= 12.79
 E2= 12.82
 E3= 4.46

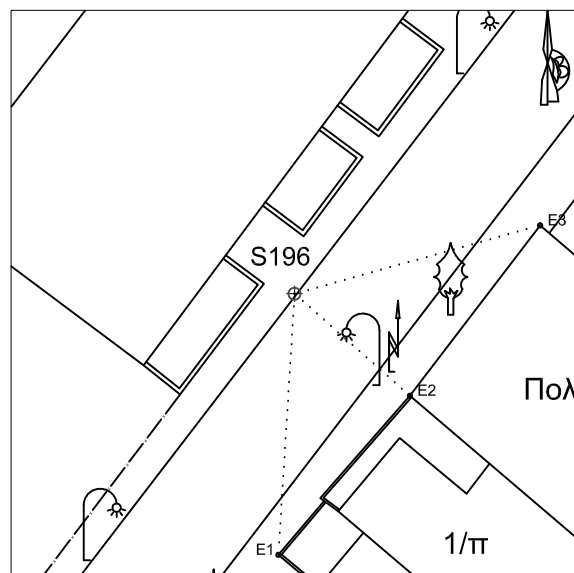
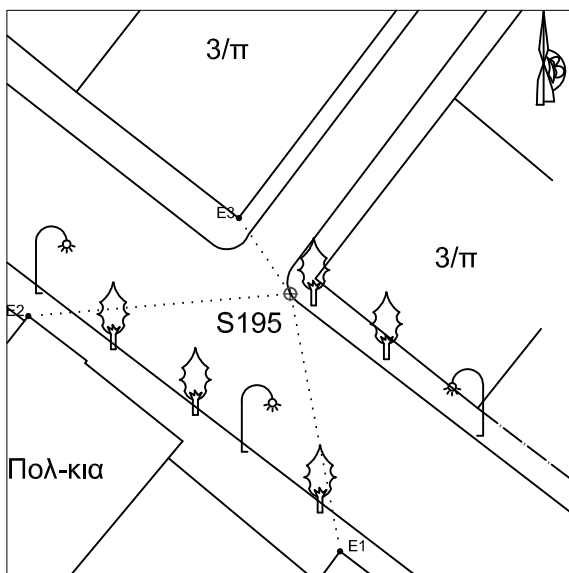

S196
 X= 408243.422
 Y=4500820.724
 H= 14.990
 E1= 11.9
 E2= 7
 E3= 11.6

S197
 X= 408164.951
 Y=4500825.593
 H= 14.699
 E1= 10.57
 E2= 12.44
 E3= 18.68

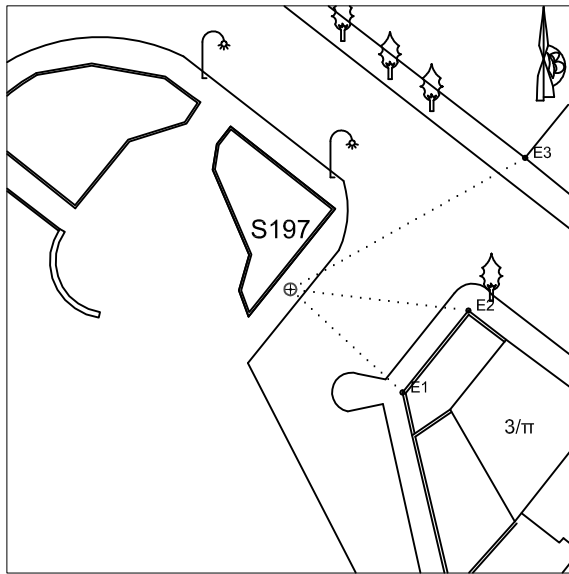

S198
 X= 408221.94
 Y=4500854.702
 H= 15.380
 E1= 12.08
 E2= 9.98
 E3= 9.26

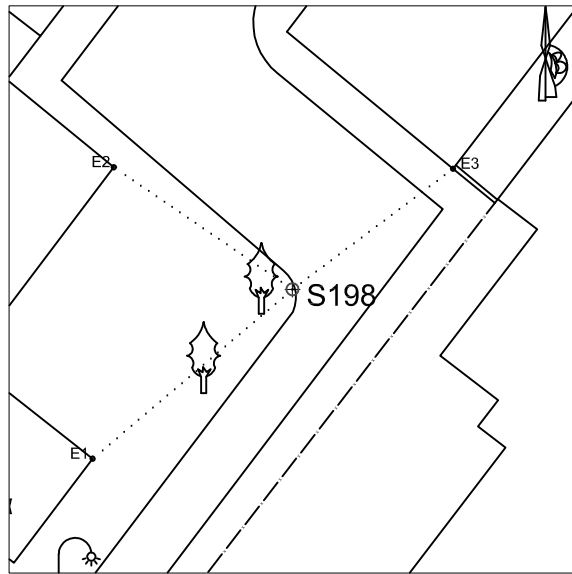

S199
 X= 408172.766
 Y=4500791.247
 H= 14.872
 E1= 13.57
 E2= 9.51
 E3= 13.18

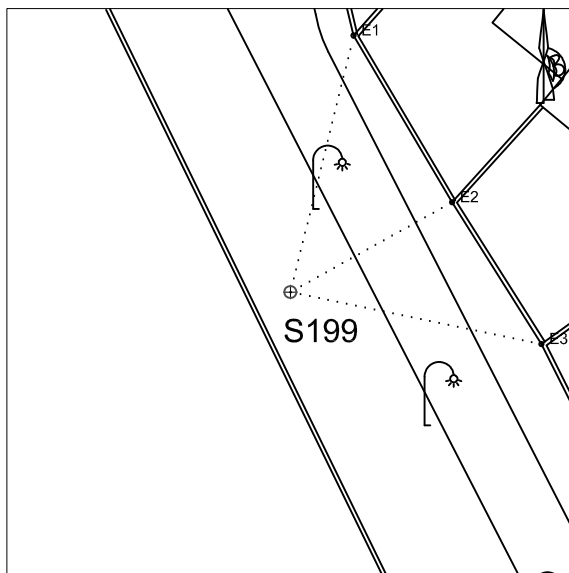

S200
 X= 408154.844
 Y=4500876.137
 H= 14.803
 E1= 33.35
 E2= 29.5
 E3= 15.75

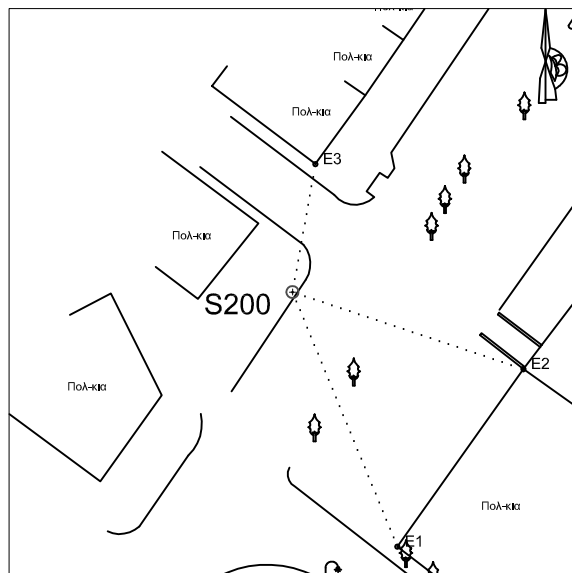

S201
 X= 408196.41
 Y=4500926.738
 H= 15.540
 E1= 16.95
 E2= 18.47
 E3= 30.01

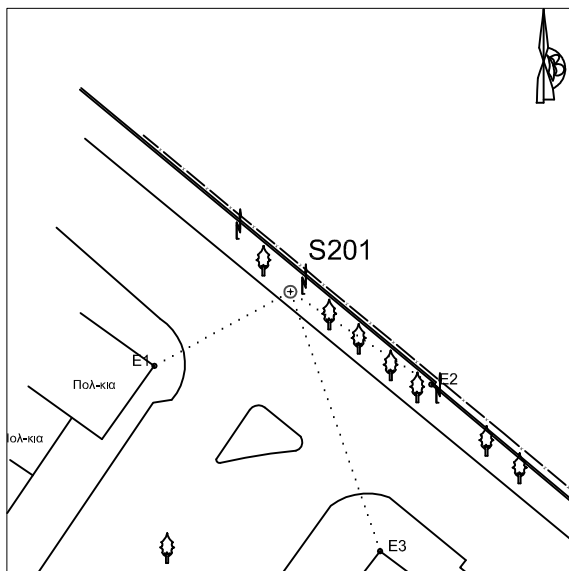

S164A
X= 408538.496
Y=4500520.958
H= 14.423
E1= 7.8
E2= 7
E3= 12.53

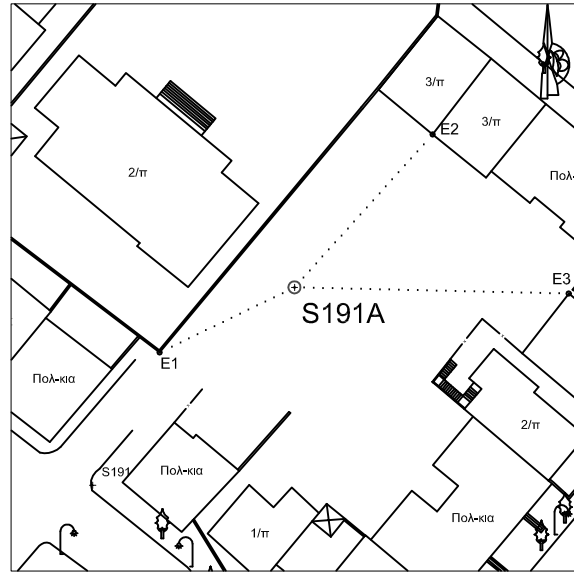
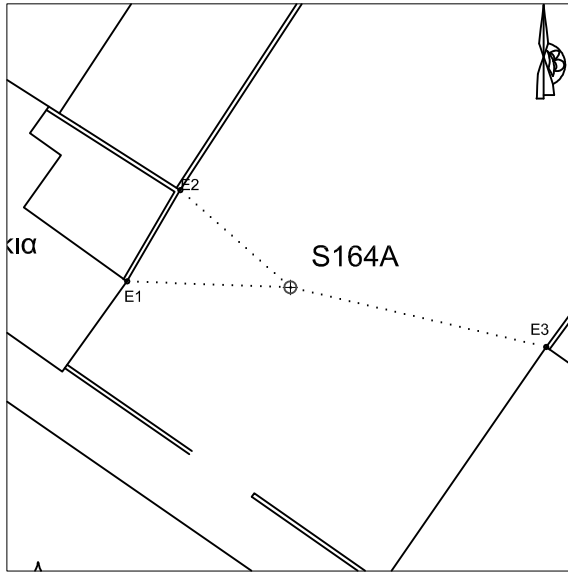

S191A
X= 408290.852
Y=4500787.956
H= 14.894
E1= 16.51
E2= 22.74
E3= 30.29

S202
X= 408226.754
Y=4500886.026
H= 15.634
E1= 9.59
E2= 1.76
E3= 8.04

