

**ΤΕΥΧΟΣ ΕΞΑΣΦΑΛΙΣΕΩΝ
ΠΟΛΥΓΩΝΟΜΕΤΡΙΚΟΥ ΔΙΚΤΥΟΥ ΤΩΝ ΠΕ 09 & ΠΕ 11**



**Σ Π Υ Ρ Ι Δ Ο Π Ο Υ Λ Ο Σ Β.
Γ Ρ Η Γ Ο Ρ Ι Ο Σ**

**Ι Ω Α Ν Ν Η Χ Α Λ Κ Ι Δ Η 63
Α Μ Π Ε Λ Ο Κ Η Π Ο Ι**

**Τ Η Λ Γ ρ α φ . : 2310
725900 Κ ι ν . 6936865624**

Α ρ . f a x : 2310 725900

1/6/2011

ΤΙΤΛΟΣ ΜΕΛΕΤΗΣ:

**« ΣΥΝΤΑΞΗ ΠΡΟΓΡΑΦΙΚΟΥ ΥΠΟΒΑΘΡΟΥ ΓΙΑ ΜΕΛΕΤΗ
ΑΝΑΠΛΑΣΗΣ ΤΩΝ ΠΟΛΕΟΔΟΜΙΚΩΝ ΕΝΟΤΗΤΩΝ ΠΕ 09
& ΠΕ 11 ΤΟΥ ΔΗΜΟΥ ΑΜΠΕΛΟΚΗΠΩΝ »**

S1
 X= 408406.491
 Y=4500755.037
 H= 16.351
 E1= 7.75
 E2= 13.52
 E3= 18.49

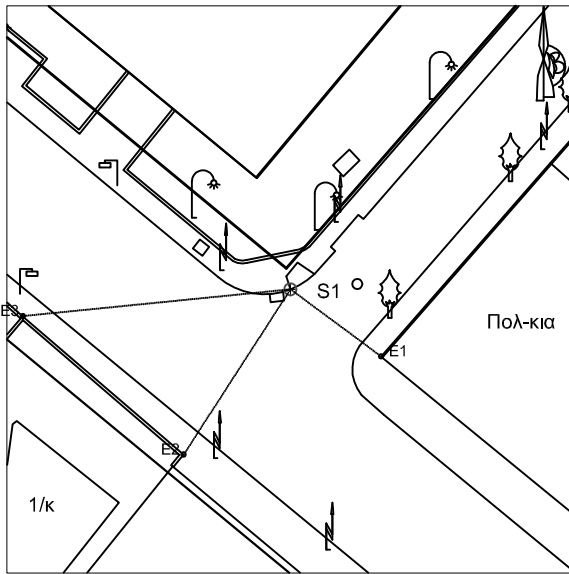

S2
 X= 408382.015
 Y=4500772.141
 H= 16.292
 E1= 11.41
 E2= 14.86
 E3= 5.32

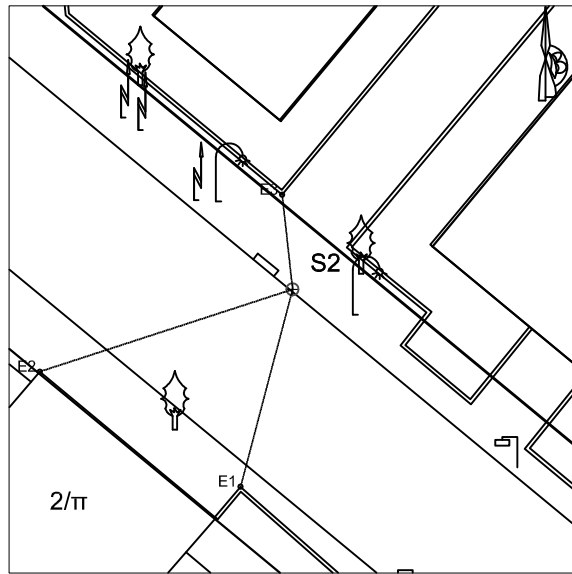

S3
 X= 408432.255
 Y=4500773.606
 H= 16.662
 E1= 0.79
 E2= 6.18
 E3= 8.24

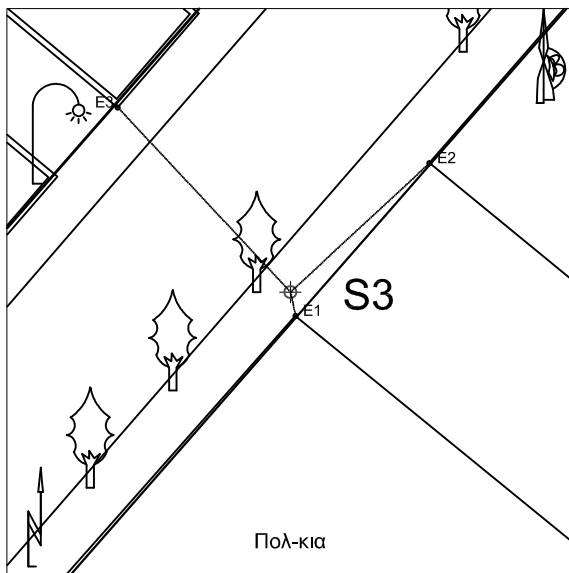

S4
 X= 408463.33
 Y=4500819.552
 H= 16.983
 E1= 1.54
 E2= 3.08
 E3= 7.89

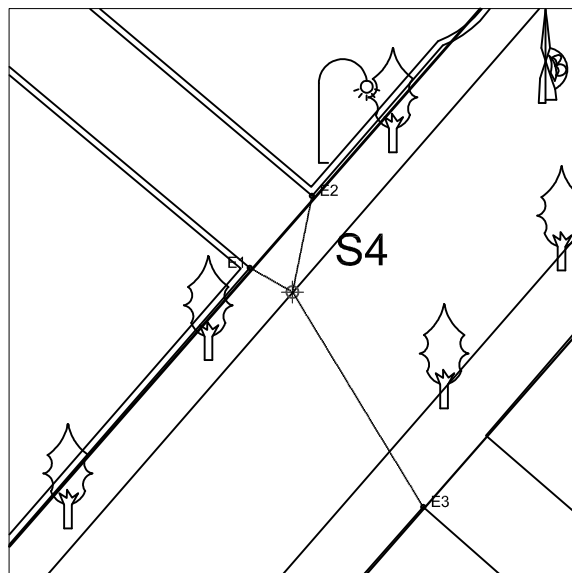

S5
 X= 408438.942
 Y=4500841.366
 H= 16.974
 E1= 5.76
 E2= 6.86
 E3= 9.09

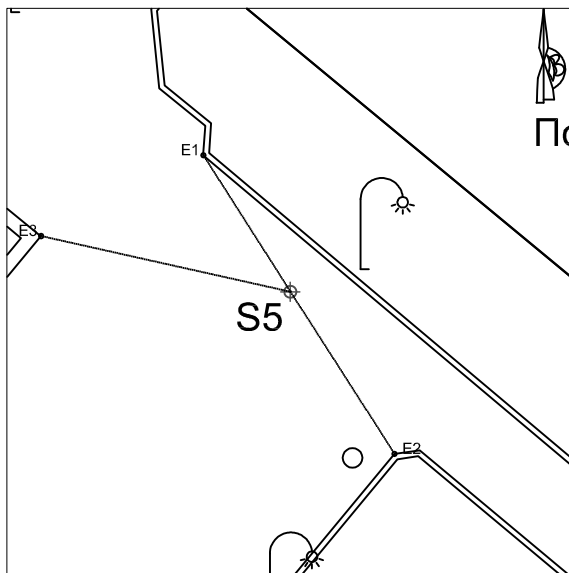

S6
 X= 408491.558
 Y=4500842.729
 H= 17.293
 E1= 8.87
 E2= 16.58
 E3= 10.89

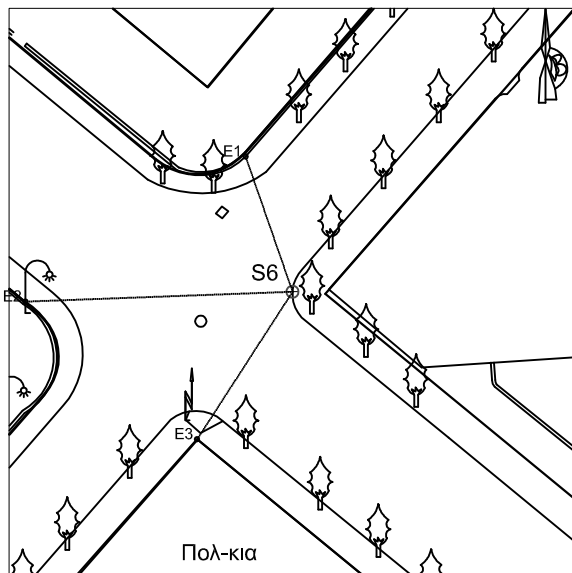

S7
 X= 408498.902
 Y=4500824.349
 H= 17.524
 E1= 16.16
 E2= 2.5
 E3= 19.98

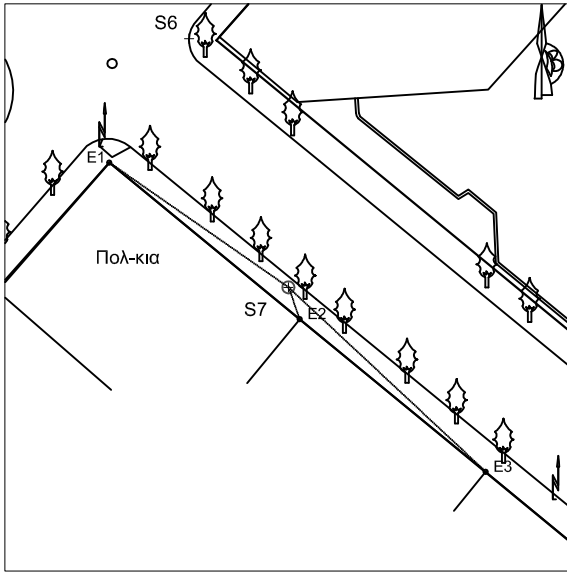

S8
 X= 408515.943
 Y=4500882.224
 H= 17.753
 E1= 4.22
 E2= 2.23
 E3= 10.73

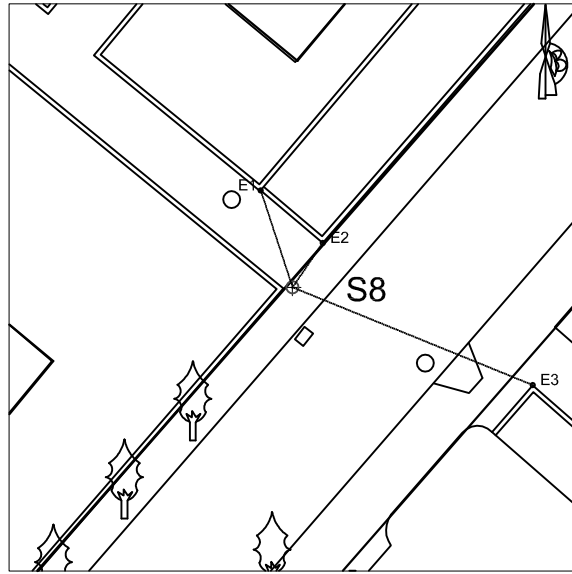

S9
 X= 408469.581
 Y=4500860.462
 H= 17.092
 E1= 1.66
 E2= 10.78
 E3= 11.09

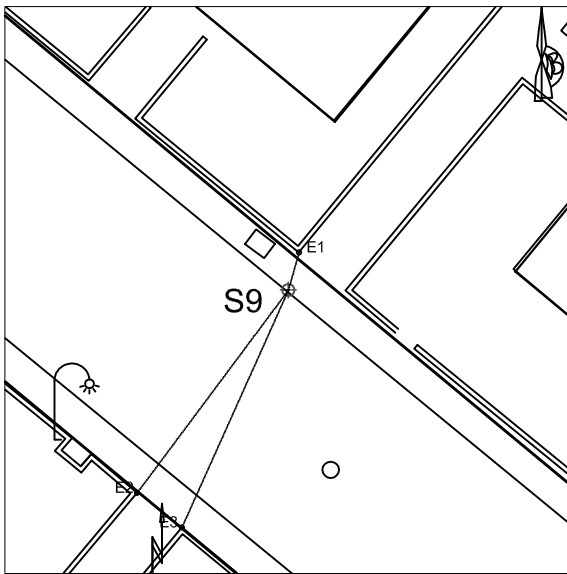

S10
 X= 408498.659
 Y=4500896.434
 H= 17.389
 E1= 6.15
 E2= 7.74
 E3= 15.4

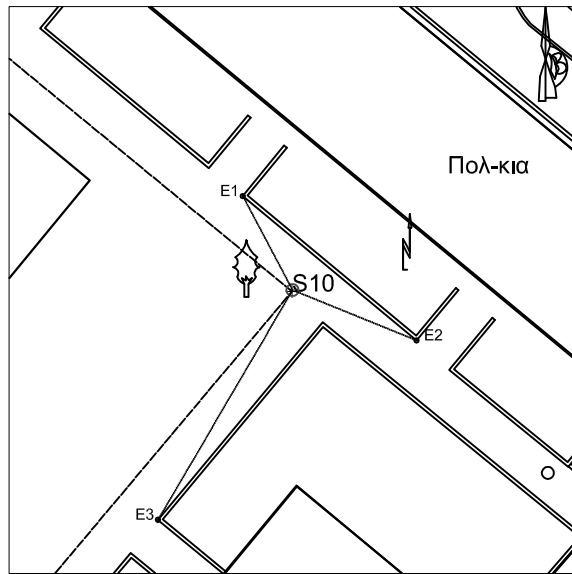

S11
 X= 408476.344
 Y= 4500917.23
 H= 17.114
 E1= 1.97
 E2= 18.49
 E3= 21.63

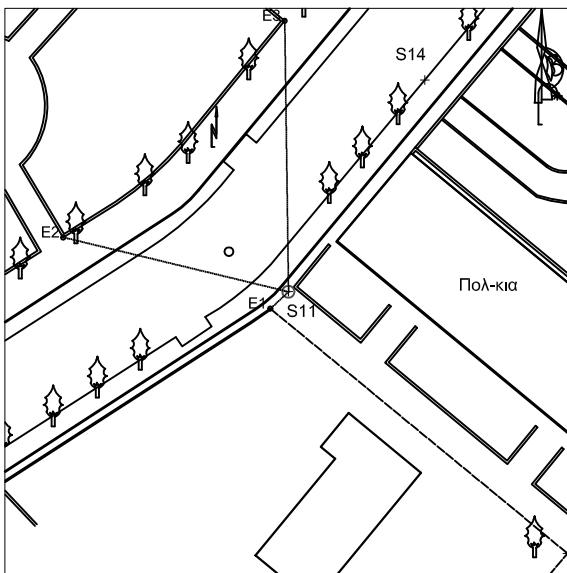

S12
 X= 408535.641
 Y=4500902.986
 H= 17.901
 E1= 8.58
 E2= 8.15
 E3= 11.14

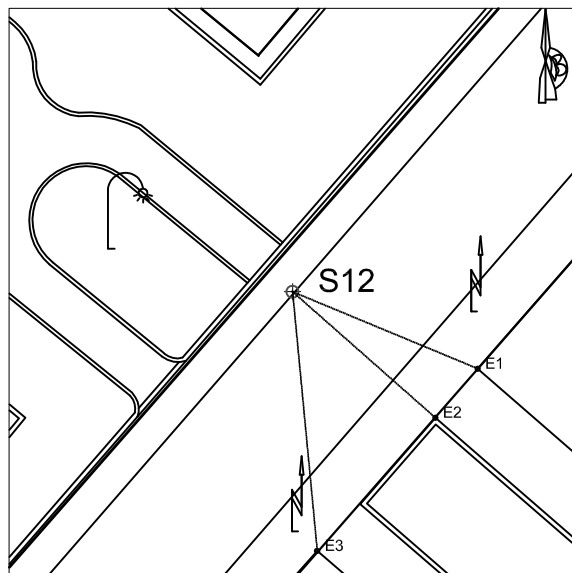

S13
 X= 408564.666
 Y= 4500923.94
 H= 18.061
 E1= 11.54
 E2= 19.16
 E3= 14.08

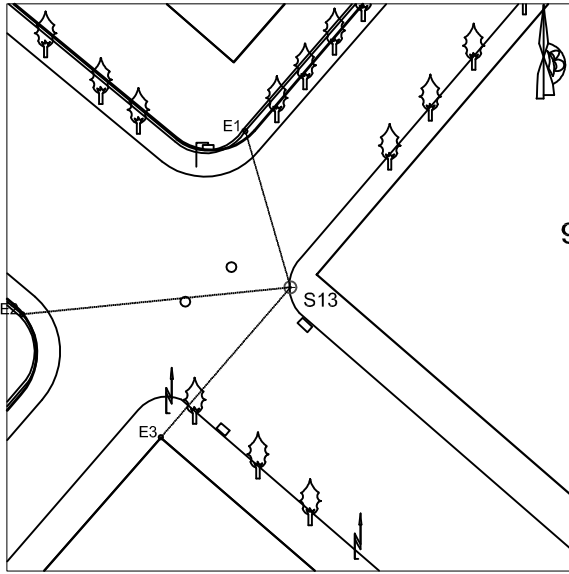

S14
 X= 408487.241
 Y=4500934.127
 H= 17.203
 E1= 20.84
 E2= 12.16
 E3= 5.9

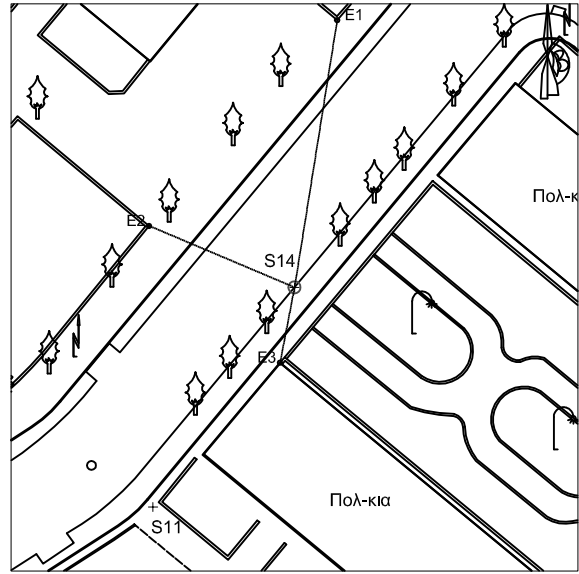

S15
 X= 408592.18
 Y=4500885.159
 H= 18.263
 E1= 3.58
 E2= 5.82
 E3= 14.92

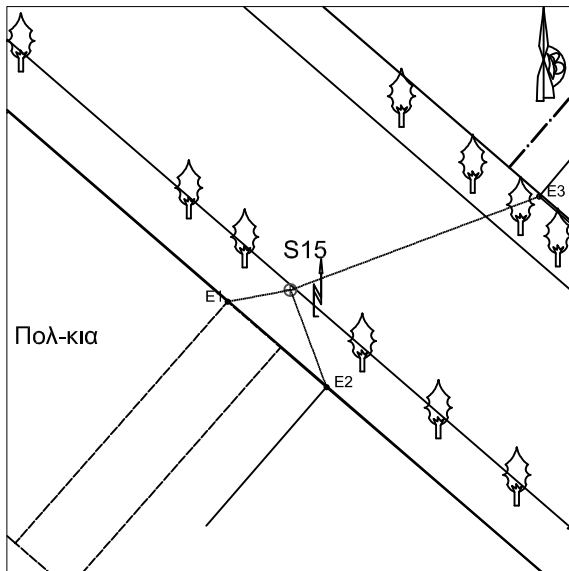

S15A
 X= 408603.658
 Y=4500916.392
 H= 18.541
 E1= 17.37
 E2= 17.21
 E3= 23.19

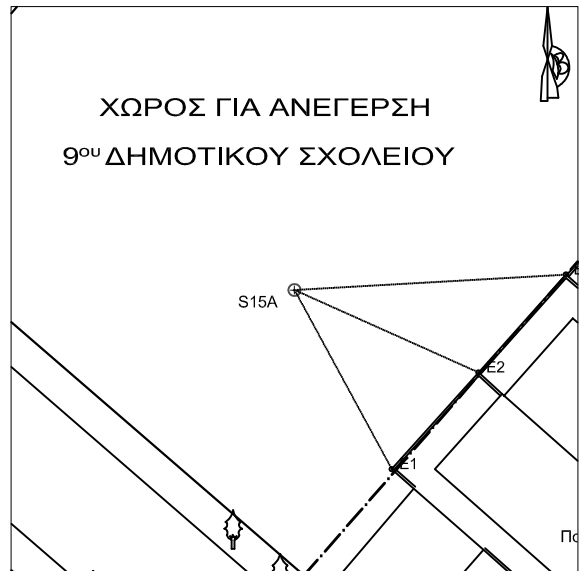

S17
 X= 408505.013
 Y=4500967.259
 H= 17.435
 E1= 2.69
 E2= 9.74
 E3= 14.04

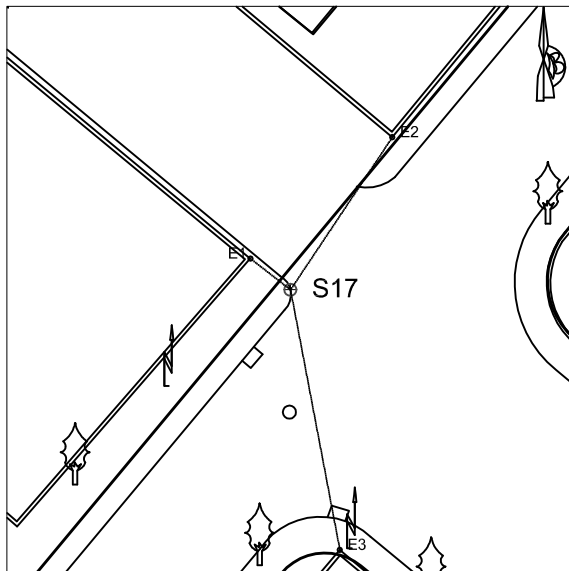

S18
 X= 408484.21
 Y=4500985.767
 H= 17.326
 E1= 27.04
 E2= 5.41
 E3= 7.5

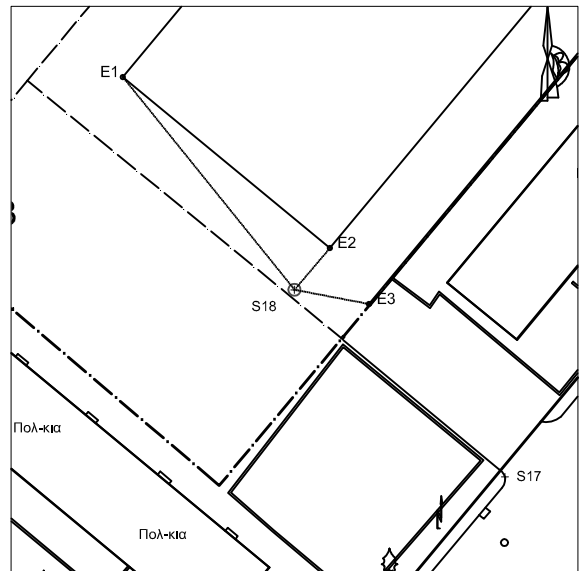

S19
X= 408547.144
Y=4501004.934
H= 18.038
E1= 13.44
E2= 10.03
E3= 14.04

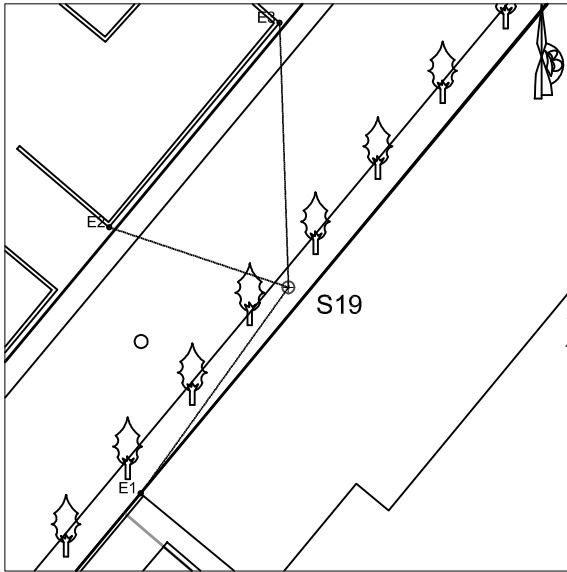

S20
X= 408451.935
Y=4500962.384
H= 17.054
E1= 4.75
E2= 3.3
E3= 3.17

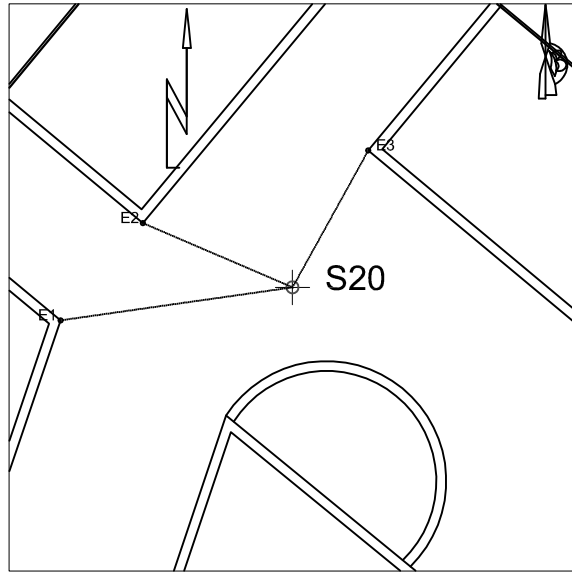

S21
X= 408438.553
Y=4500931.332
H= 16.911
E1= 6.57
E2= 5.08
E3= 7.31

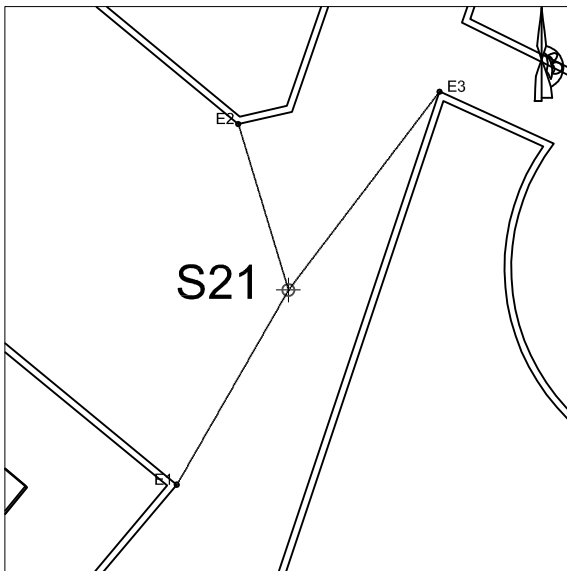

S22
X= 408427.066
Y=4500896.474
H= 16.831
E1= 13.27
E2= 13.41
E3= 11.9

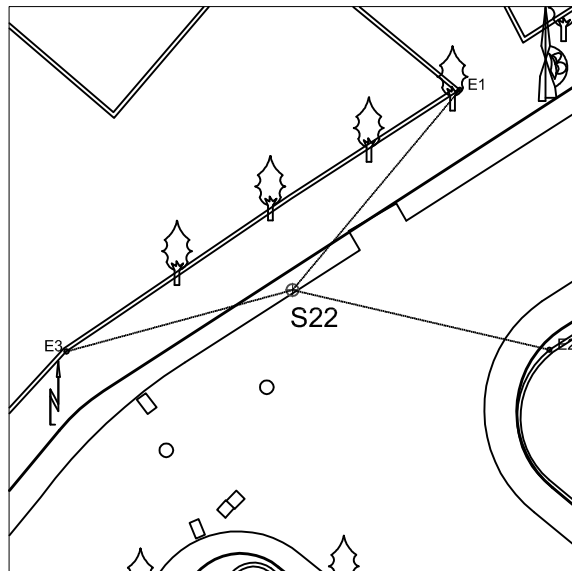

S23
X= 408392.749
Y=4500926.184
H= 16.851
E1= 22.61
E2= 12.47
E3= 11.17

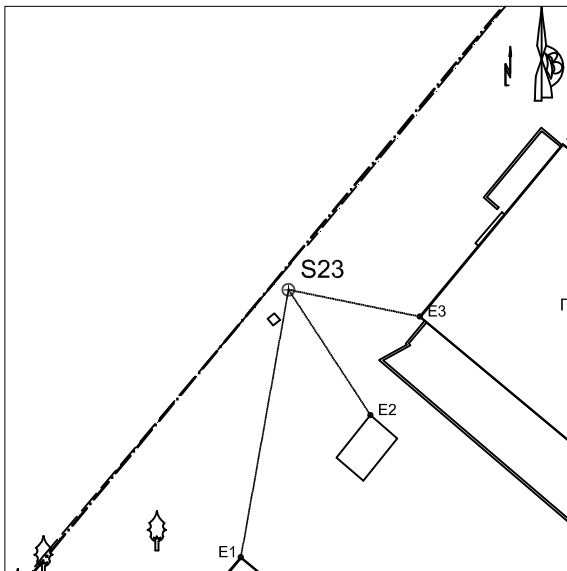

S24
X= 408383.707
Y=4500849.062
H= 16.590
E1= 17.63
E2= 11.25
E3= 7.94

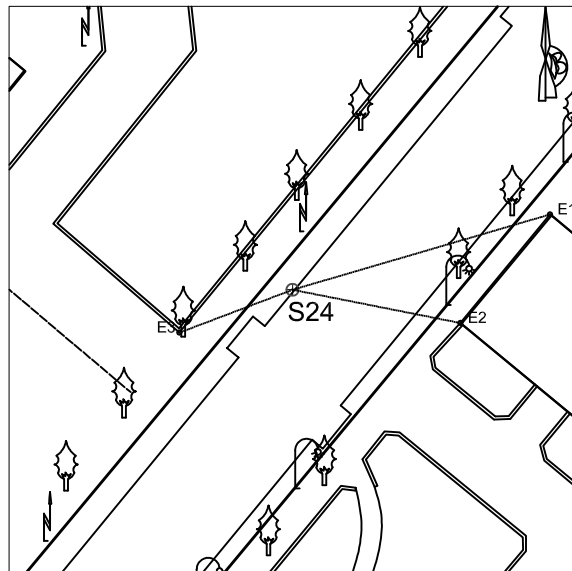

S25
 X= 408354.189
 Y=4500801.675
 H= 16.286
 E1= 23.81
 E2= 18.13
 E3= 13.8

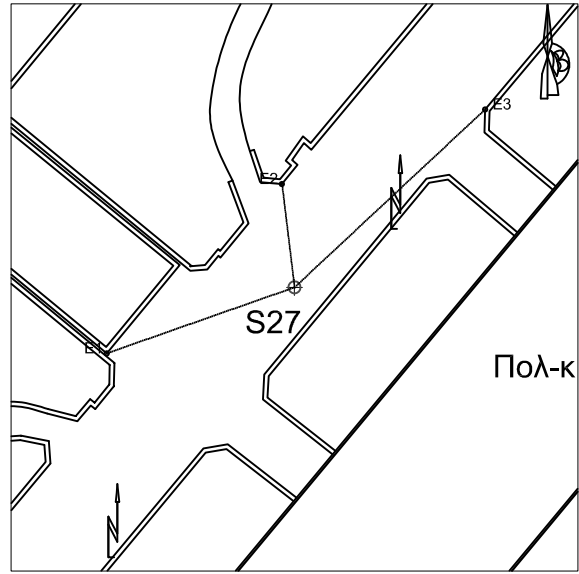
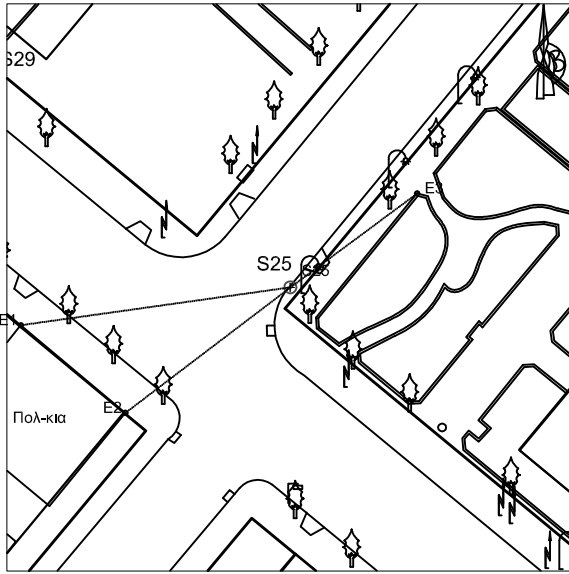

S27
 X= 408388.419
 Y=4500813.918
 H= 16.461
 E1= 8.74
 E2= 4.57
 E3= 11.45

S28
 X= 408350.757
 Y=4500847.834
 H= 16.580
 E1= 7.65
 E2= 3.74
 E3= 2.35

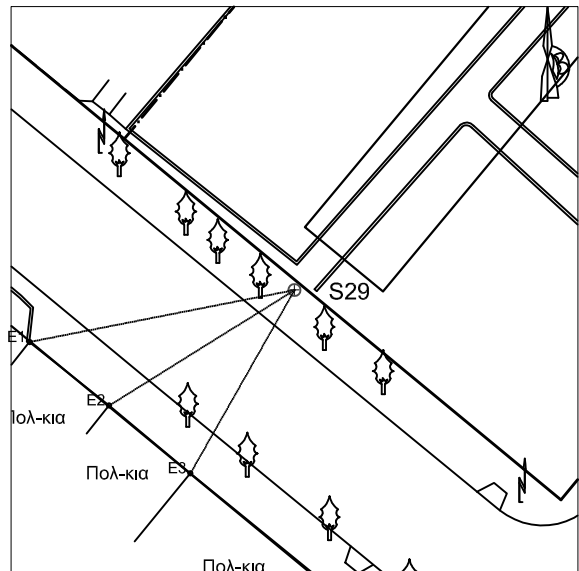
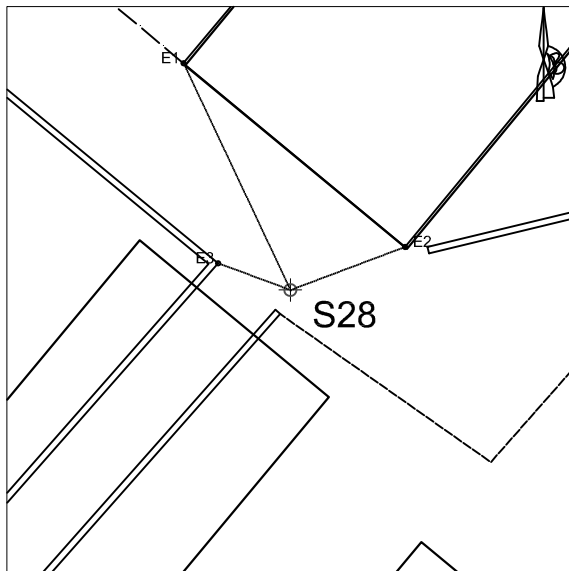

S29
 X= 408326.295
 Y=4500821.743
 H= 16.165
 E1= 20
 E2= 16.18
 E3= 15.6

S31
 X= 408340.741
 Y=4500859.931
 H= 16.438
 E1= 13.72
 E2= 19.45
 E3= 3.82

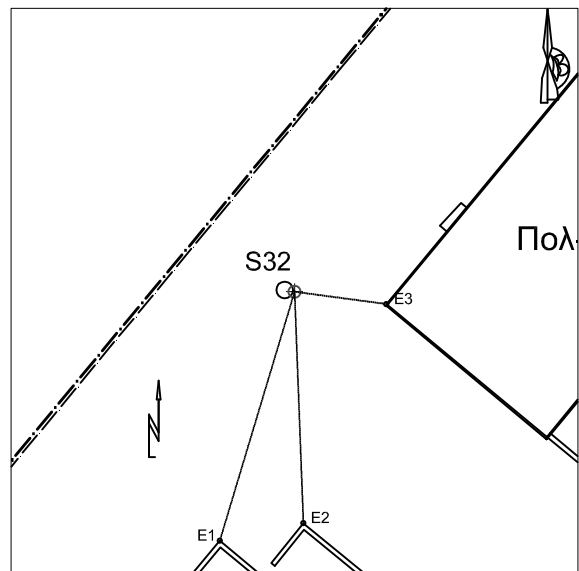
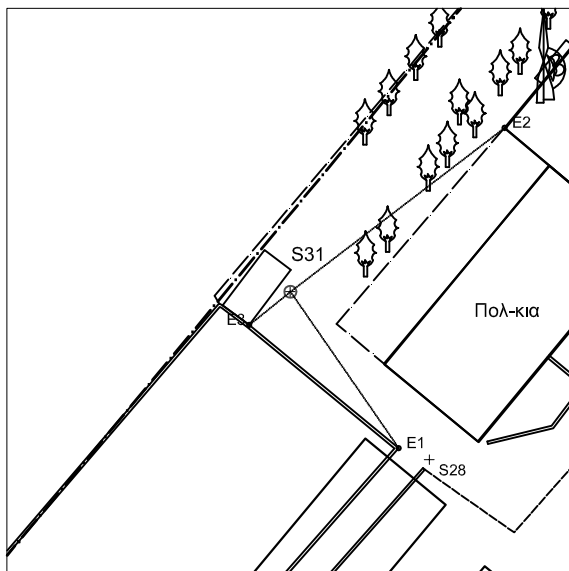

S32
 X= 408416.959
 Y=4500950.152
 H= 17.062
 E1= 10.94
 E2= 9.75
 E3= 3.9

S33
X= 408449.603
Y=4500991.146
H= 17.003
E1= 14.23
E2= 10.07
E3= 40.85

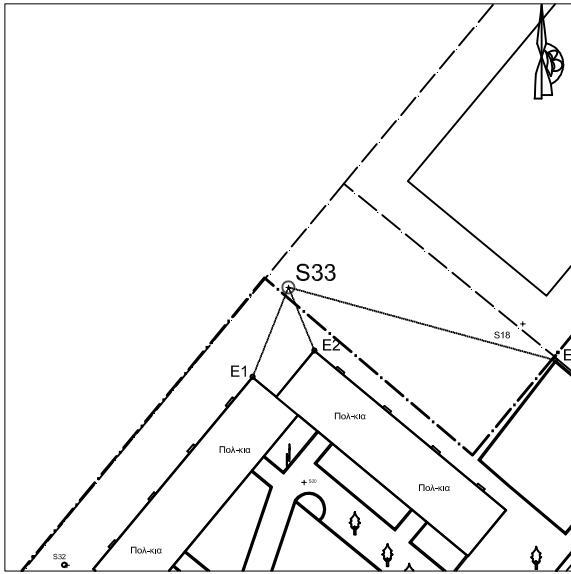

S34
X= 408577.79
Y=4501054.108
H= 18.661
E1= 6.2
E2= 9.88
E3= 16.06

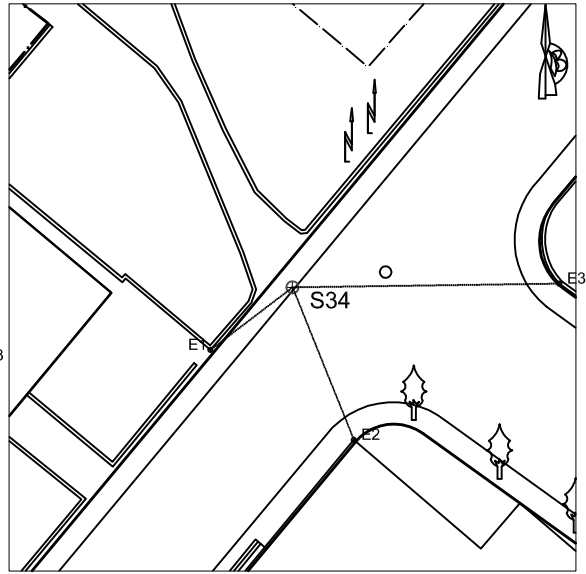

S35
X= 408615.545
Y=4501036.913
H= 18.950
E1= 24.45
E2= 20.05
E3= 4.53

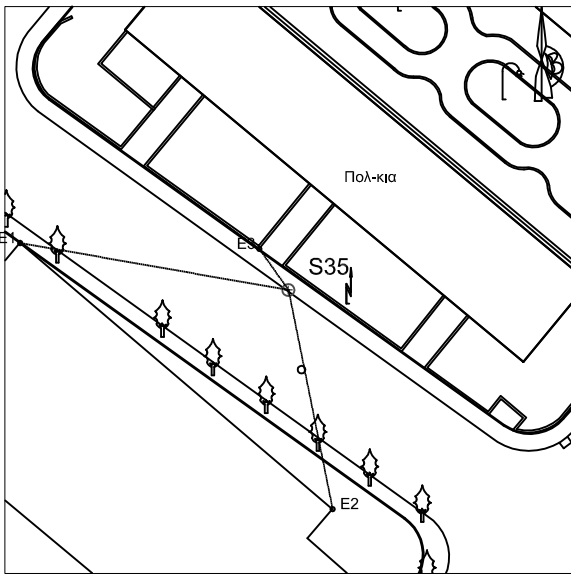

S36
X= 408604.286
Y=4501074.444
H= 19.064
E1= 13.33
E2= 11.74
E3= 7.44

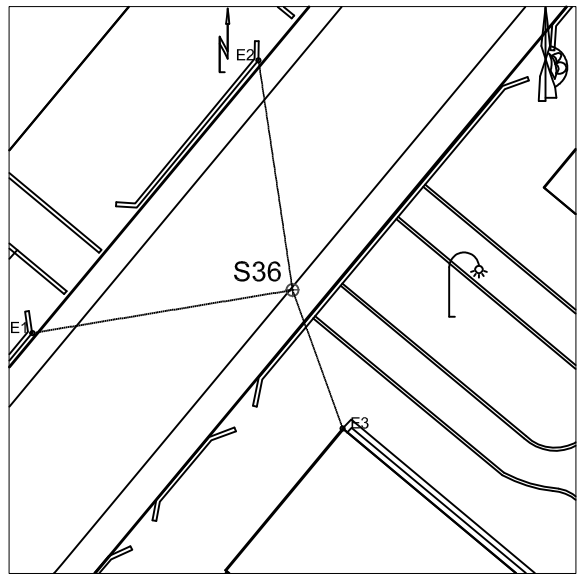

S37
X= 408561.206
Y=4501076.238
H= 19.190
E1= 7.66
E2= 11.79
E3= 6.81

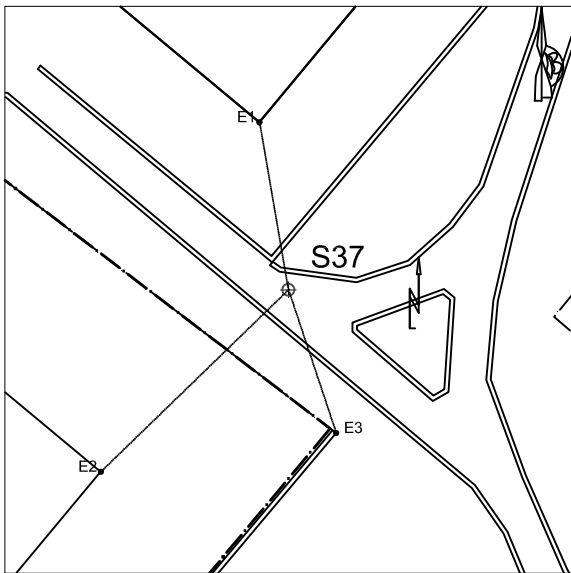

S38
X= 408624.717
Y=4501093.385
H= 19.443
E1= 18.8
E2= 10.46
E3= 6.91

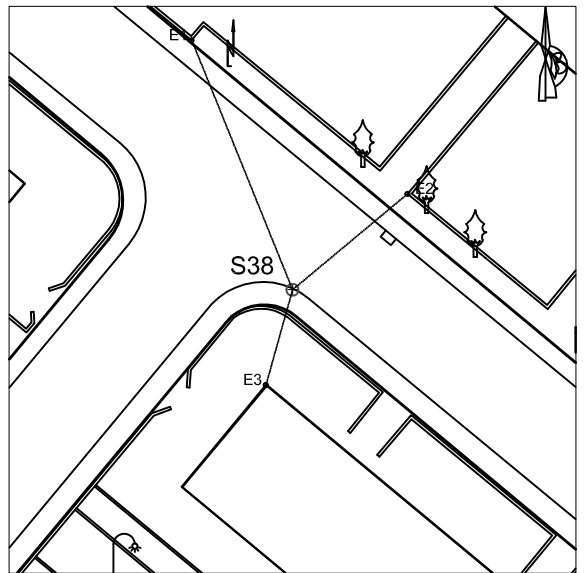

S39
X= 408596.165
Y=4501126.521
H= 19.642
E1= 7.88
E2= 8.36
E3= 20.32

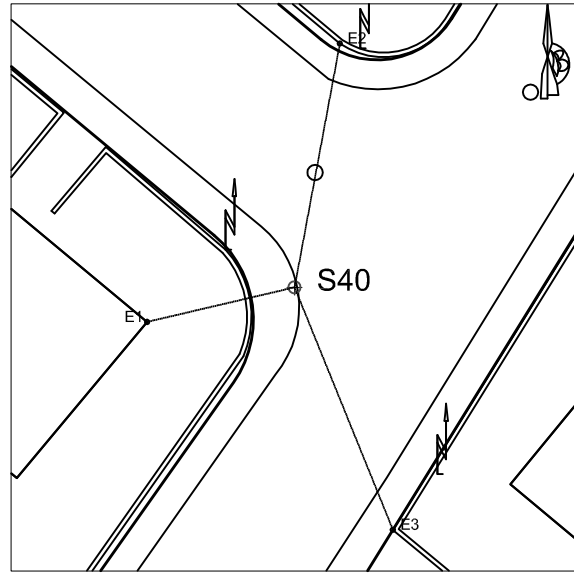
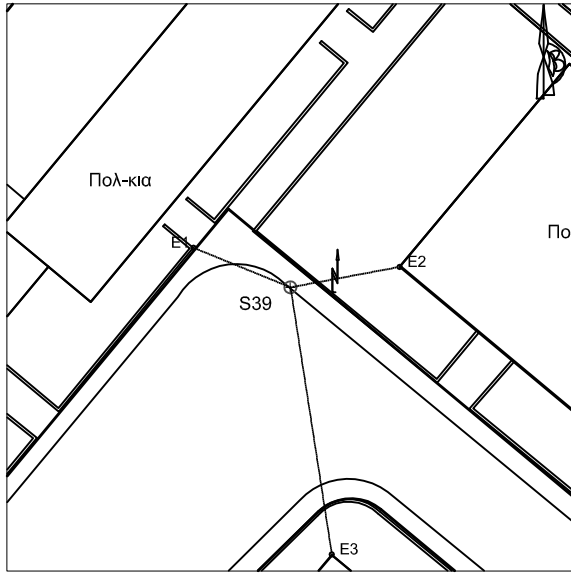

S40
X= 408665.407
Y=4501058.557
H= 19.594
E1= 6.91
E2= 11.33
E3= 11.95

S42
X= 408613.845
Y=4501160.194
H= 20.370
E1= 15.98
E2= 11.25
E3= 17.18

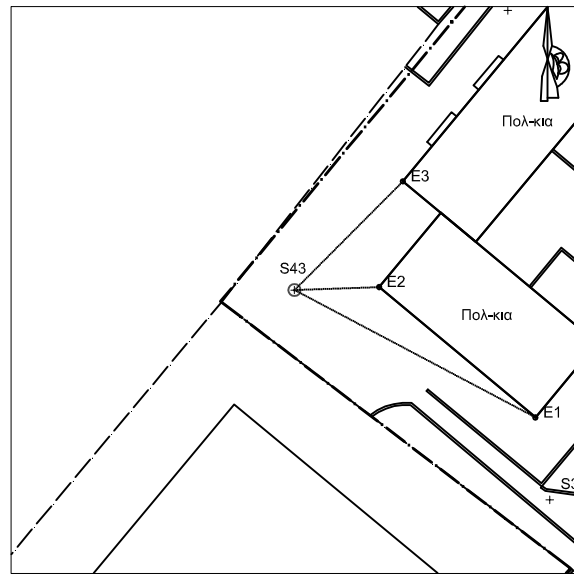
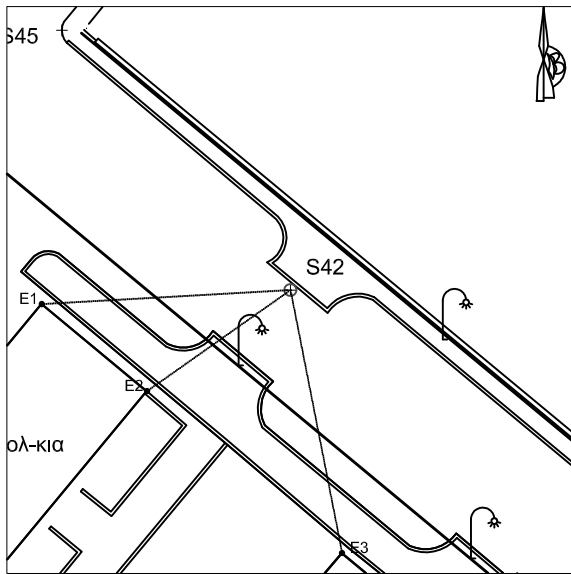

S43
X= 408537.819
Y=4501095.461
H= 19.208
E1= 24.98
E2= 7.76
E3= 14.07

S44
X= 408557.352
Y= 4501121.07
H= 19.439
E1= 18.36
E2= 10
E3= 18.75

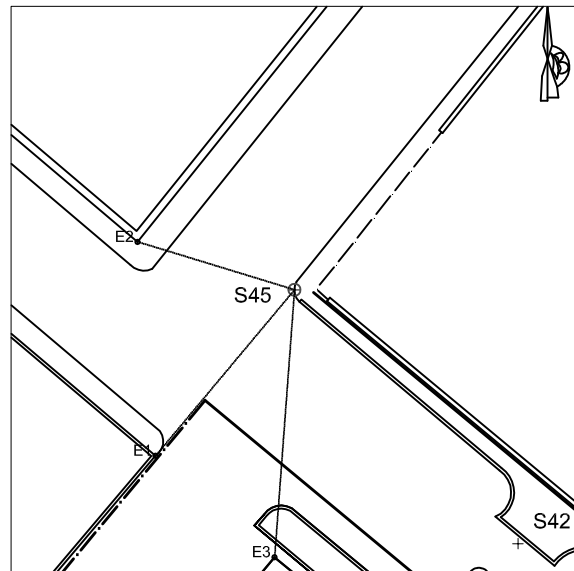
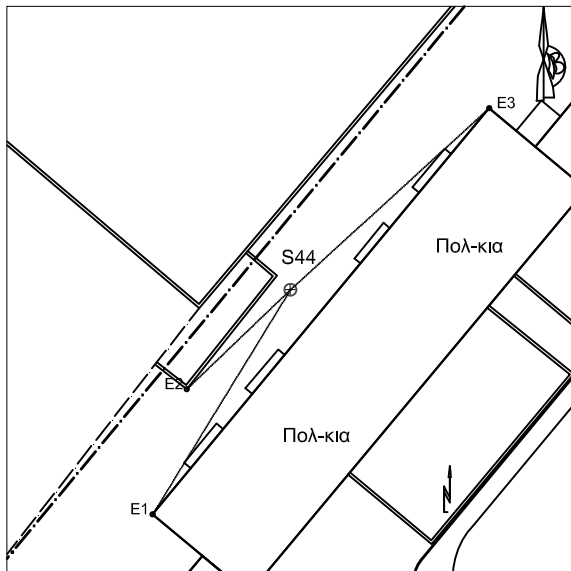

S45
X= 408599.2
Y=4501176.833
H= 20.239
E1= 14.19
E2= 10.76
E3= 17.59

S47
 X= 408644.121
 Y= 4501136.49
 H= 20.321
 E1= 11.91
 E2= 6.39
 E3= 13.58

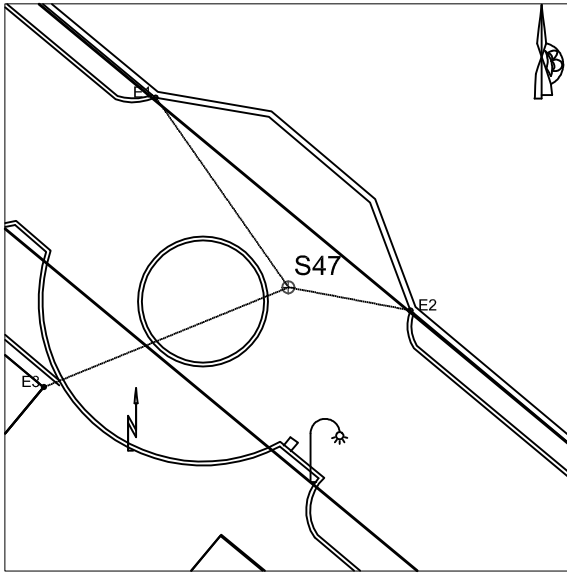

S48
 X= 408686.785
 Y=4501091.279
 H= 19.956
 E1= 6.44
 E2= 18.17
 E3= 18.32

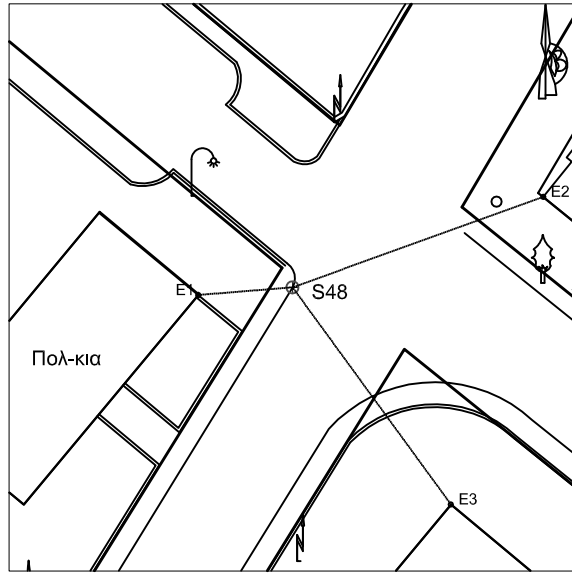

S49
 X= 408646.147
 Y=4501018.328
 H= 19.172
 E1= 13.28
 E2= 15.4
 E3= 11.43

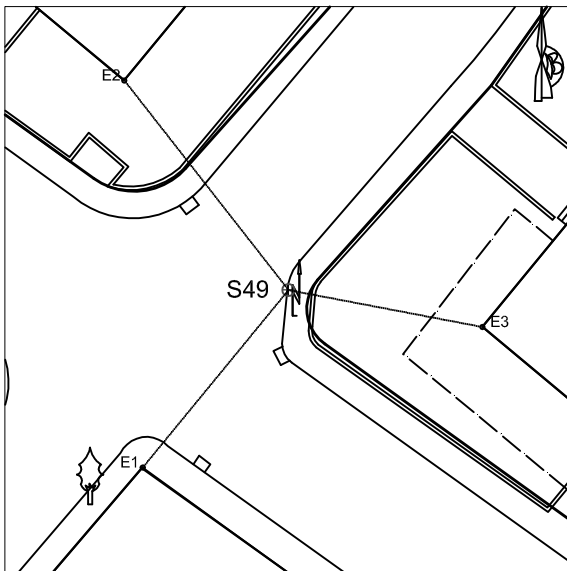

S50
 X= 408675.683
 Y=4500982.983
 H= 19.098
 E1= 12.11
 E2= 1.86
 E3= 10.04

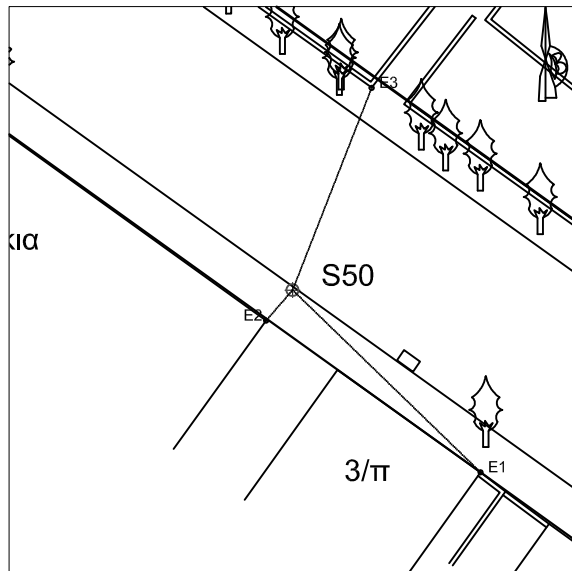

S52
 X= 408692.412
 Y=4500983.116
 H= 19.079
 E1= 20.36
 E2= 11.98
 E3= 4.82

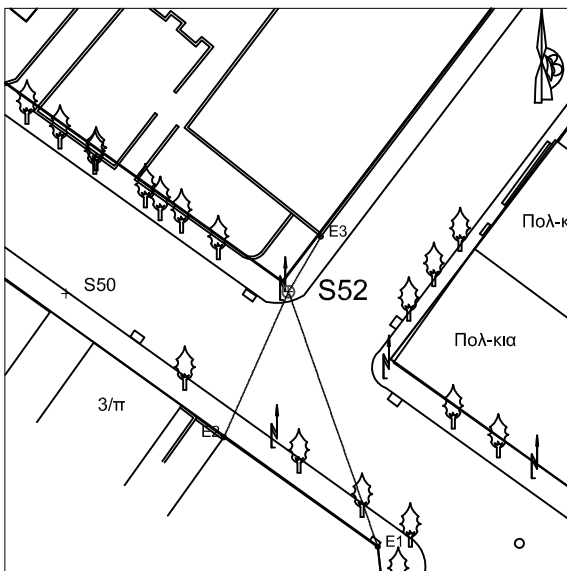

S53
 X= 408698.178
 Y=4501020.448
 H= 19.678
 E1= 5.95
 E2= 5.49
 E3= 6.41

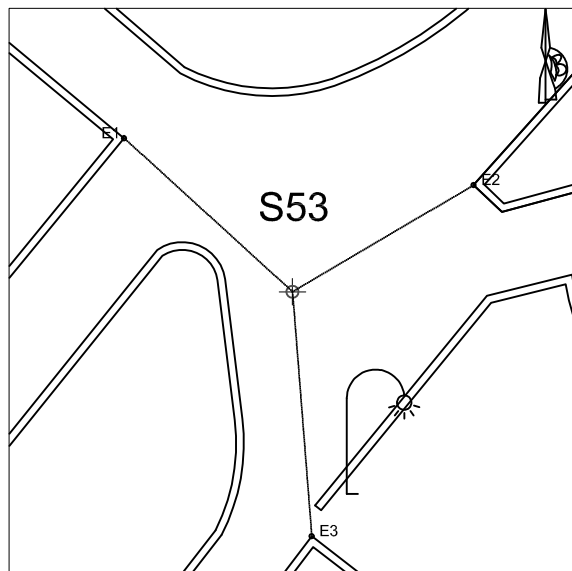

S54
 X= 408733.621
 Y=4501066.964
 H= 20.188
 E1= 16.05
 E2= 9.82
 E3= 3.83

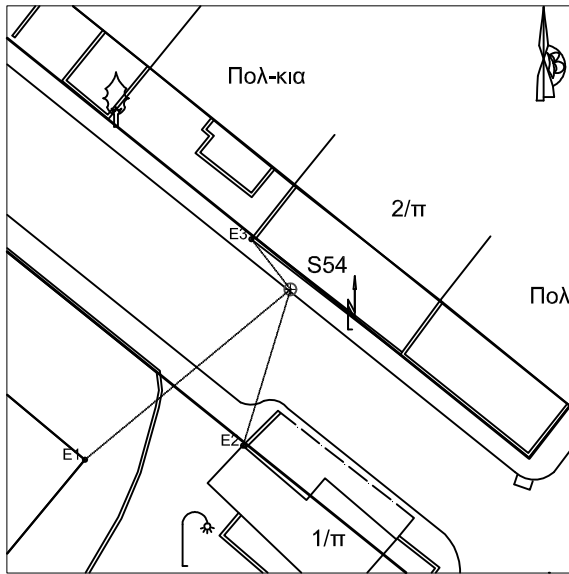

S55
 X= 408750.381
 Y=4501044.133
 H= 20.166
 E1= 15.84
 E2= 12.82
 E3= 10.09

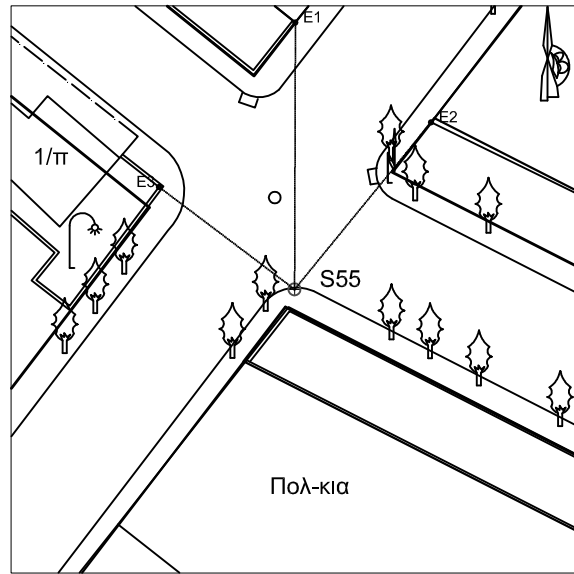

S56
 X= 408769.845
 Y=4501084.049
 H= 20.750
 E1= 10.43
 E2= 7.54
 E3= 9.45

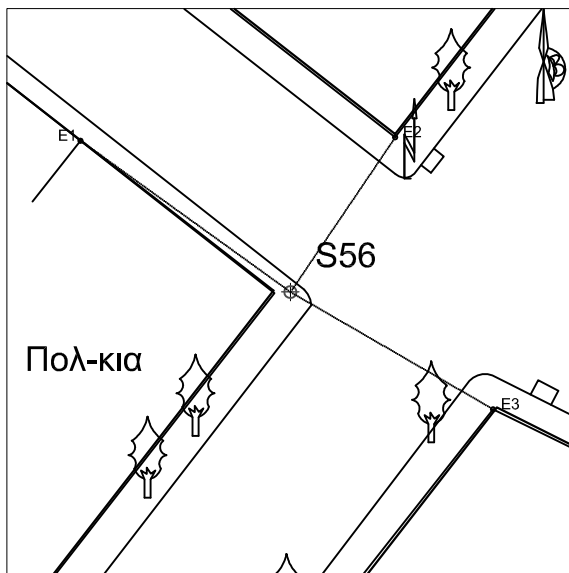

S57
 X= 408790.796
 Y=4501021.669
 H= 20.307
 E1= 7.29
 E2= 3.7
 E3= 14.15

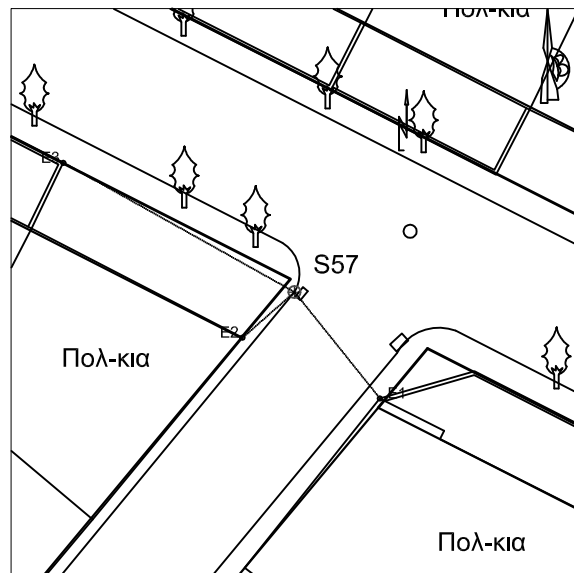

S58
 X= 408710.694
 Y=4500956.921
 H= 19.080
 E1= 11.89
 E2= 11.32
 E3= 1.35

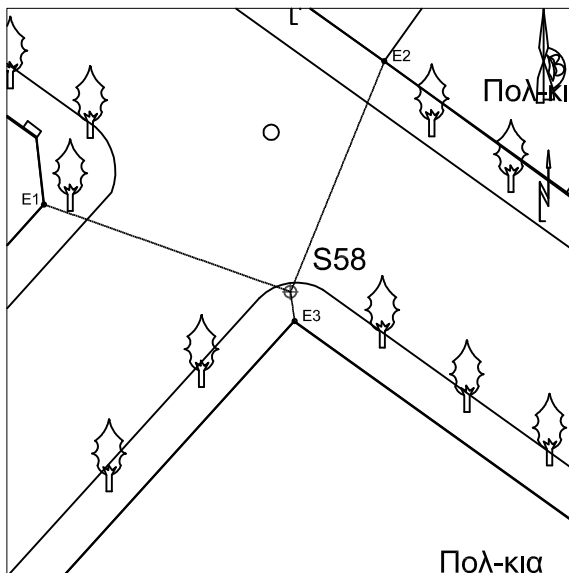

S59
 X= 408662.216
 Y=4500916.781
 H= 18.531
 E1= 12.77
 E2= 11.78
 E3= 2.64

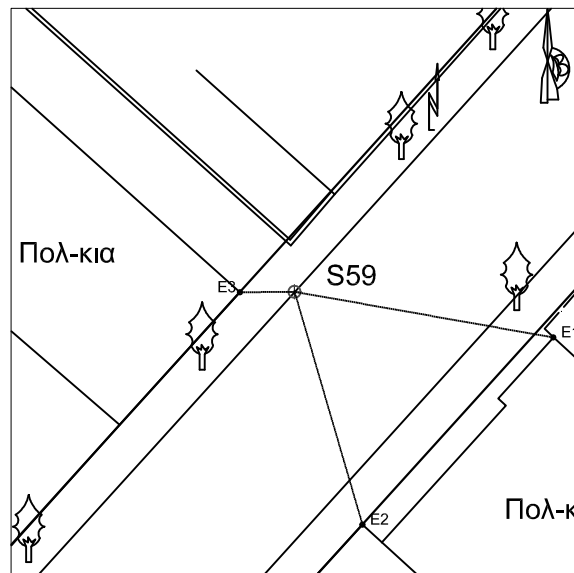

S60
 X= 408735.982
 Y=4500938.693
 H= 19.062
 E1= 15.53
 E2= 11.31
 E3= 9.16

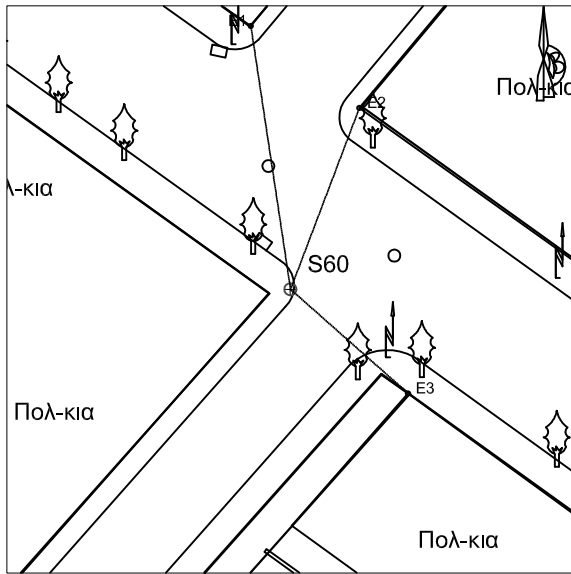

S61
 X= 408774.563
 Y=4500922.721
 H= 19.383
 E1= 3.34
 E2= 11.1
 E3= 15.06

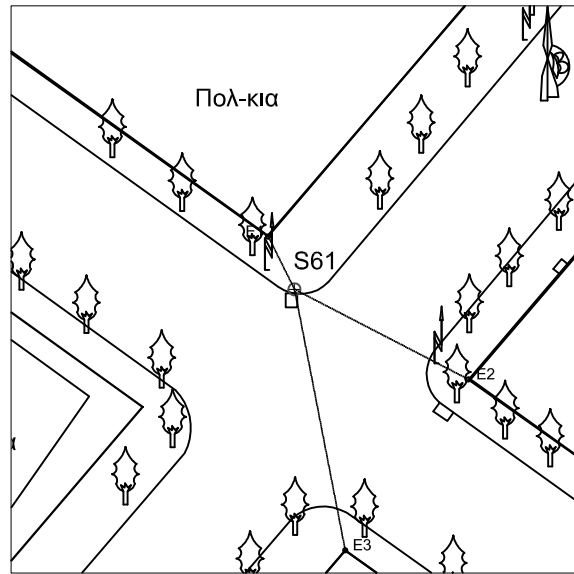

S62
 X= 408742.054
 Y=4500962.847
 H= 19.329
 E1= 11.58
 E2= 11.95
 E3= 22.69

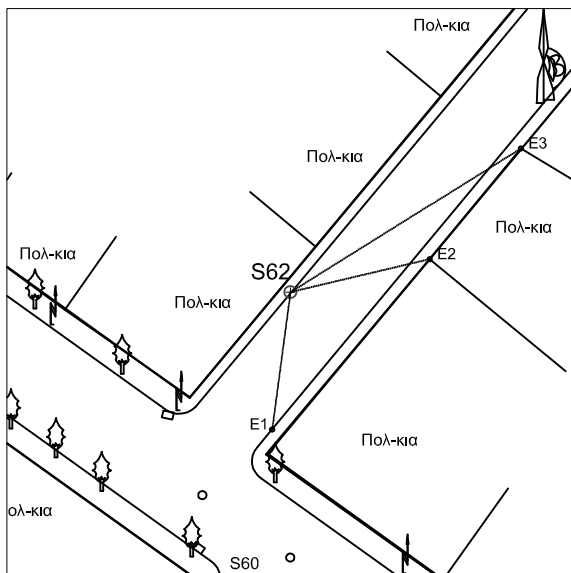

S63
 X= 408705.149
 Y=4500903.369
 H= 18.649
 E1= 9.02
 E2= 10.25
 E3= 16.18

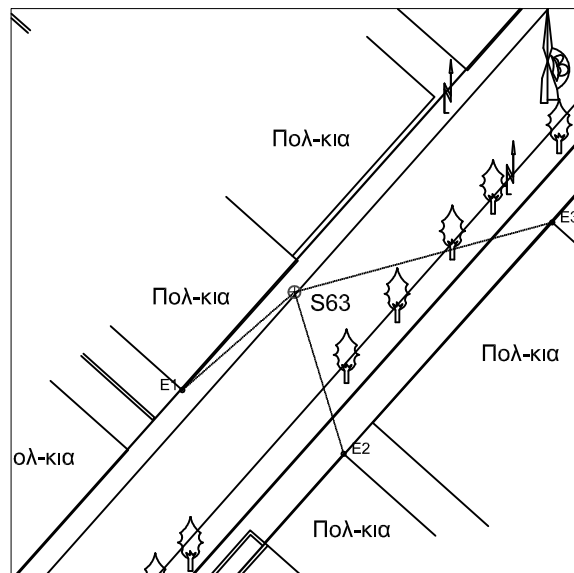

S64
 X= 408827.633
 Y=4501015.515
 H= 20.347
 E1= 17.4
 E2= 8.86
 E3= 10.94

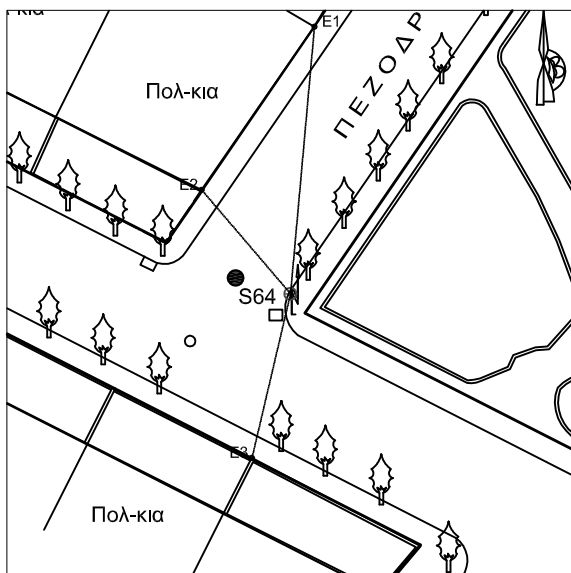

S64A
 X= 408859.811
 Y=4501015.242
 H= 20.985
 E1= 12.7
 E2= 15.07
 E3= 6.93

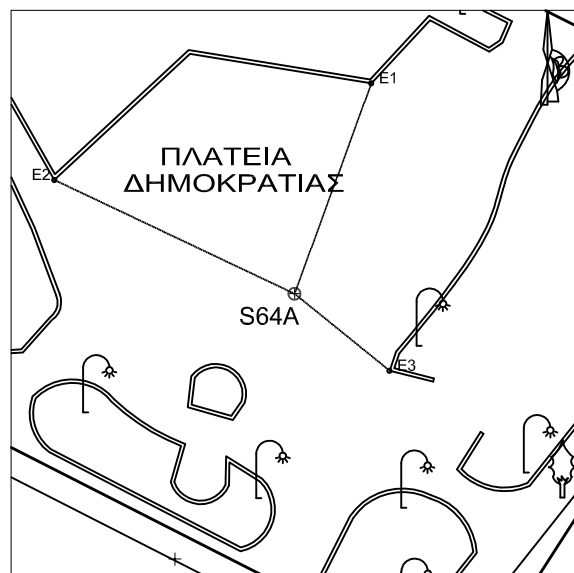

S65
 X= 408853.035
 Y=4501000.215
 H= 20.672
 E1= 16.98
 E2= 12.43
 E3= 8.97

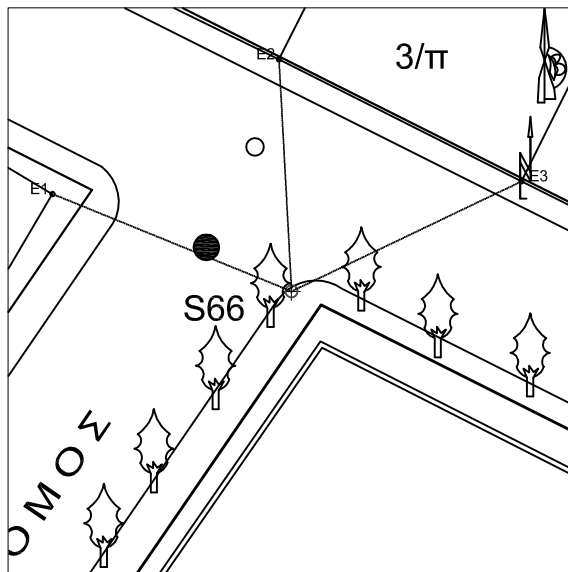
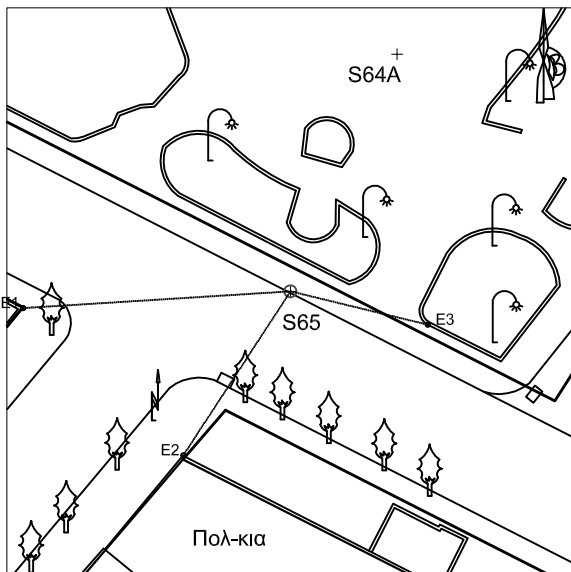

S66
 X= 408847.727
 Y=4501044.441
 H= 20.859
 E1= 10.17
 E2= 9.15
 E3= 10.04

S67
 X= 408812.418
 Y=4500952.789
 H= 19.957
 E1= 5.8
 E2= 18.83
 E3= 12.31

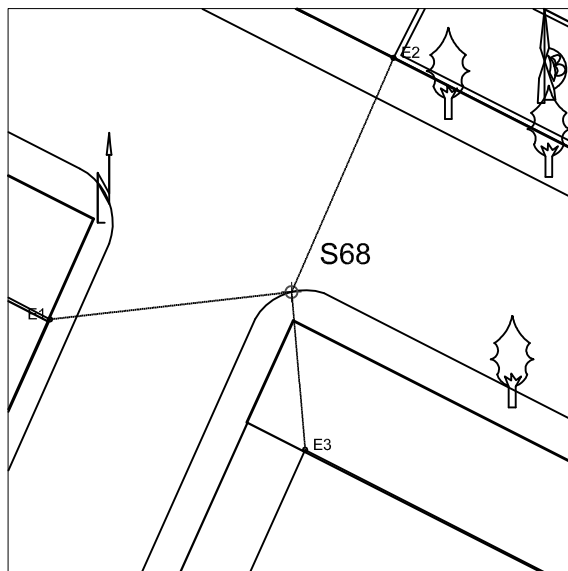
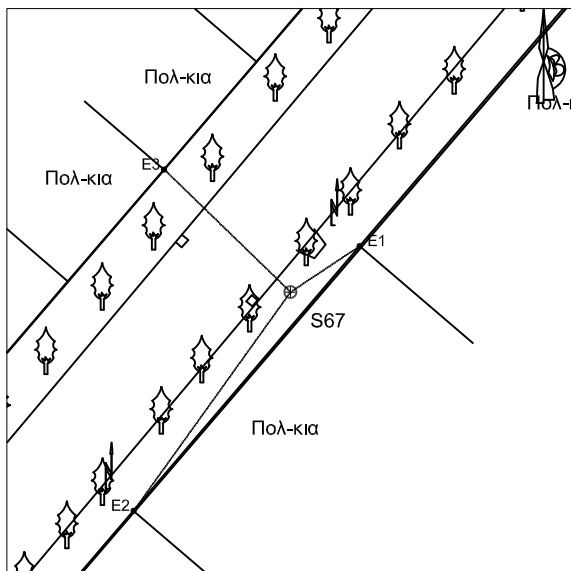

S68
 X= 408888.754
 Y=4500973.403
 H= 21.142
 E1= 8.69
 E2= 9.14
 E3= 5.66

S69
 X= 408809.512
 Y=4500887.086
 H= 19.574
 E1= 5.77
 E2= 10.37
 E3= 6.48

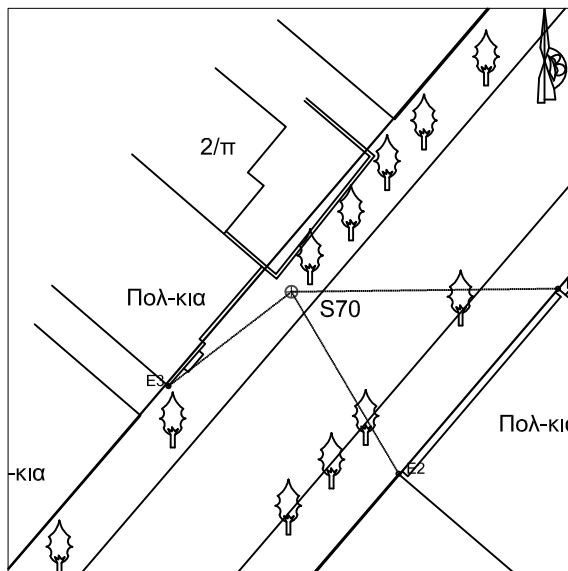
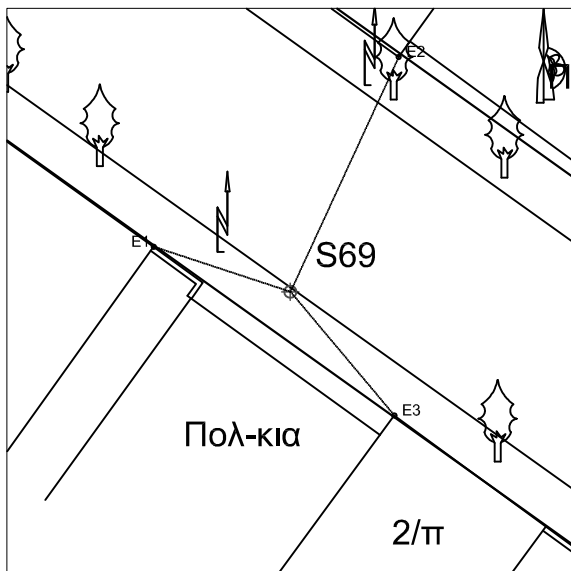

S70
 X= 408726.506
 Y= 4500866.76
 H= 18.640
 E1= 15.81
 E2= 12.53
 E3= 9.19

S71
 X= 408834.618
 Y=4500867.121
 H= 19.730
 E1= 12.5
 E2= 12.48
 E3= 12.59

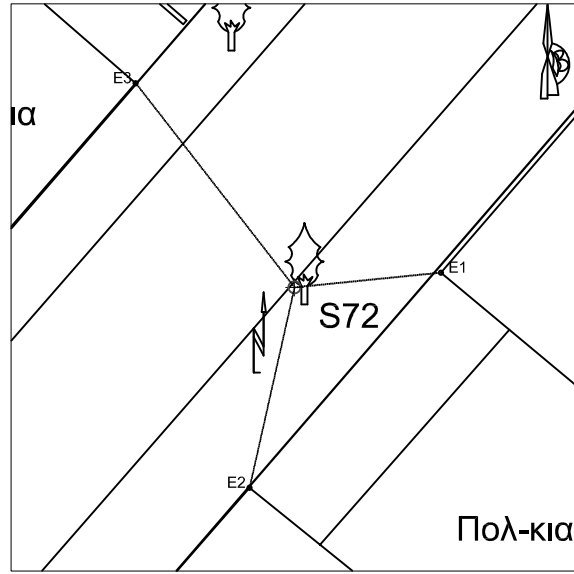
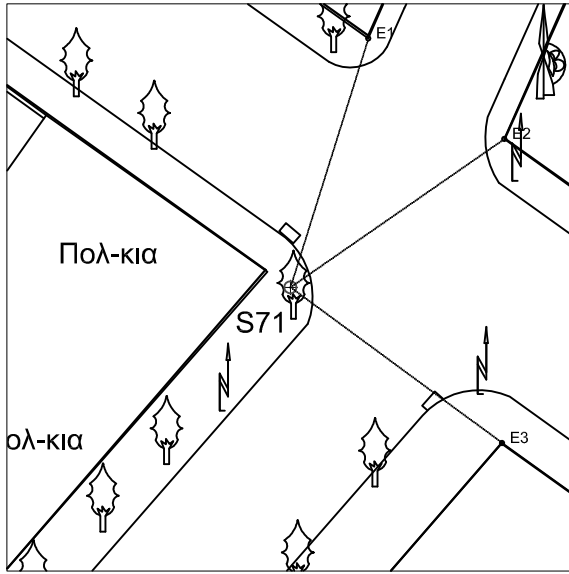

S72
 X= 408797.943
 Y=4500811.483
 H= 19.041
 E1= 5.9
 E2= 8.24
 E3= 10.37

S73
 X= 408890.025
 Y=4500840.295
 H= 20.452
 E1= 14.25
 E2= 12.98
 E3= 17.61

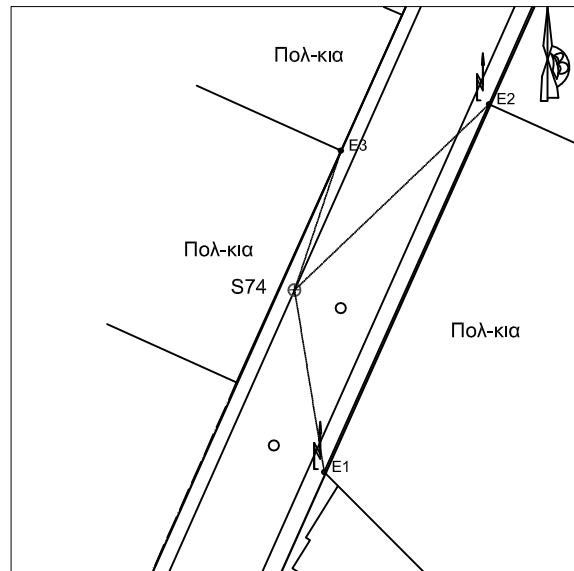
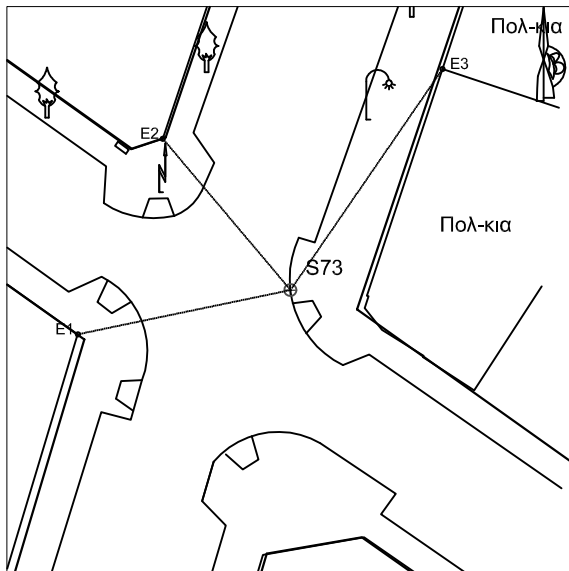

S74
 X= 408859.603
 Y=4500924.345
 H= 20.338
 E1= 12.58
 E2= 18.34
 E3= 10.02

S75
 X= 408938.134
 Y=4500955.774
 H= 21.839
 E1= 12.46
 E2= 16.6
 E3= 8.22

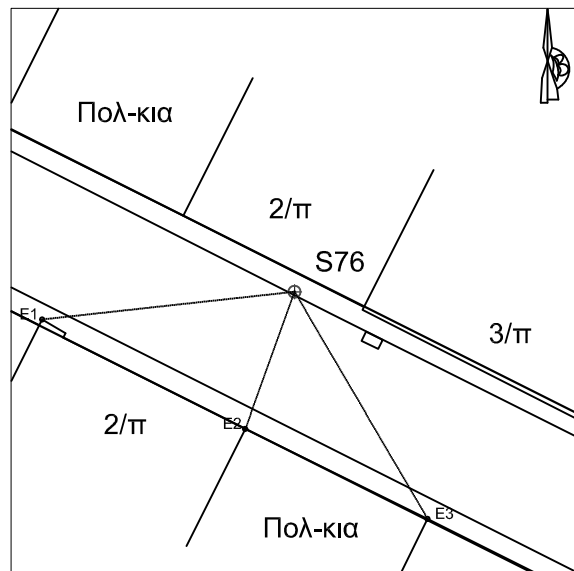
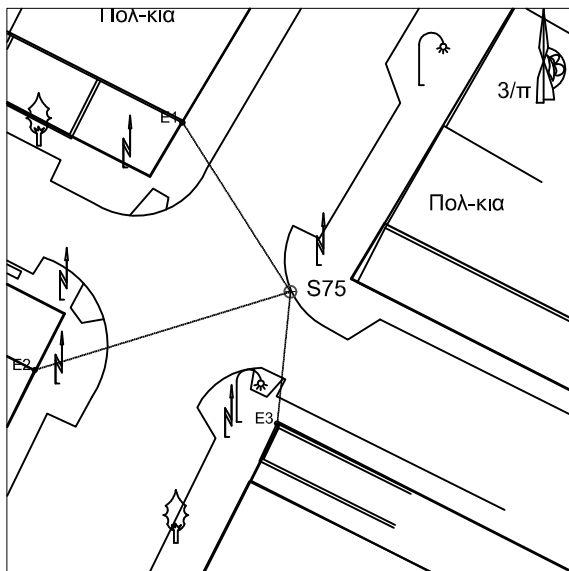

S76
 X= 408813.506
 Y=4501069.617
 H= 20.756
 E1= 12.48
 E2= 7.16
 E3= 12.94

S77
 X= 408805.64
 Y=4501129.564
 H= 21.482
 E1= 15.54
 E2= 13.51
 E3= 9.07

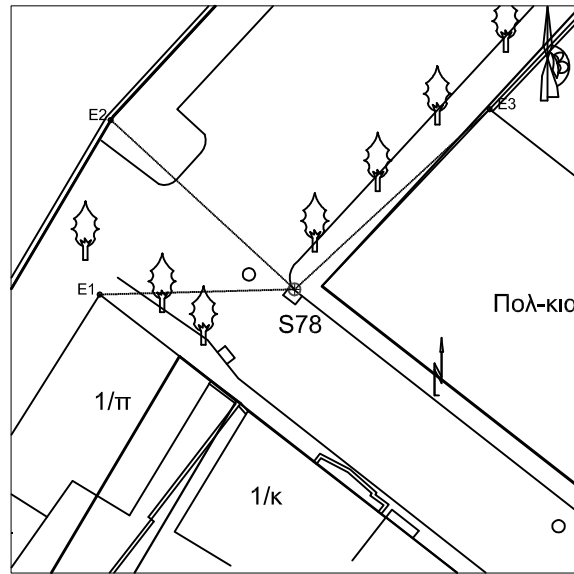
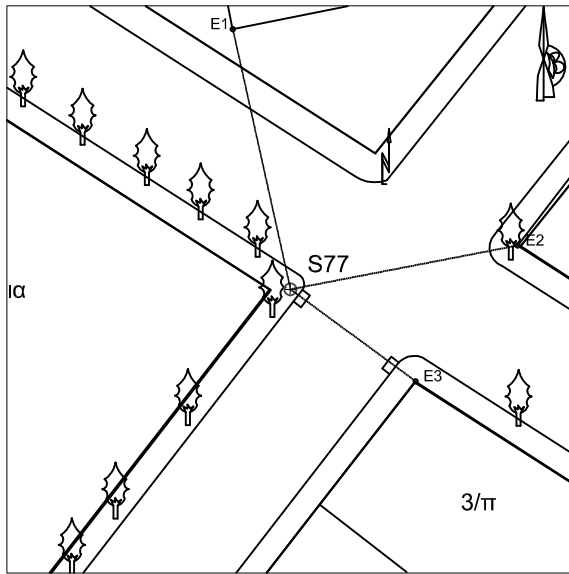

S78
 X= 408721.968
 Y=4501129.634
 H= 20.562
 E1= 10.87
 E2= 13.95
 E3= 14.83

S79
 X= 408752.966
 Y=4501163.162
 H= 21.617
 E1= 14.08
 E2= 27.61
 E3= 11.8

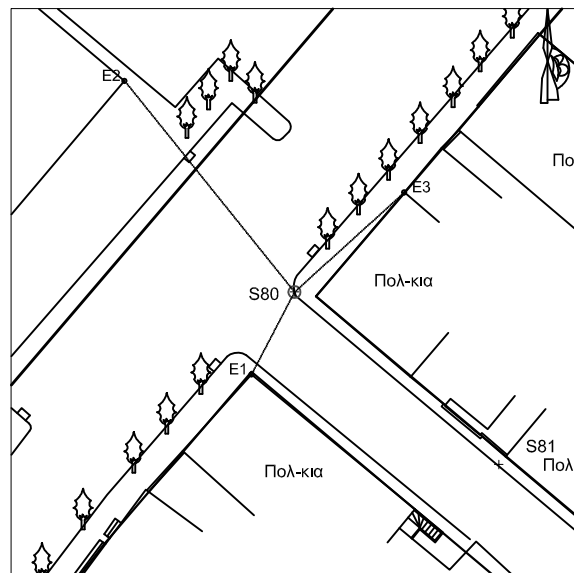
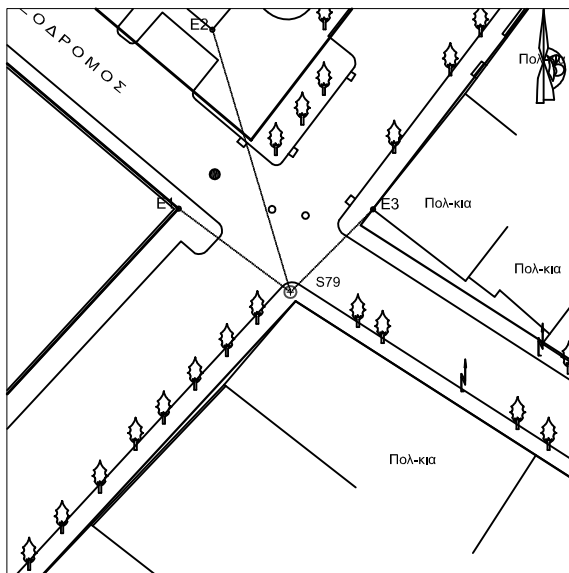

S80
 X= 408792.462
 Y=4501212.417
 H= 22.116
 E1= 7.48
 E2= 21.81
 E3= 11.92

S81
 X= 408808.89
 Y=4501198.546
 H= 22.260
 E1= 21.17
 E2= 7.65
 E3= 9.34

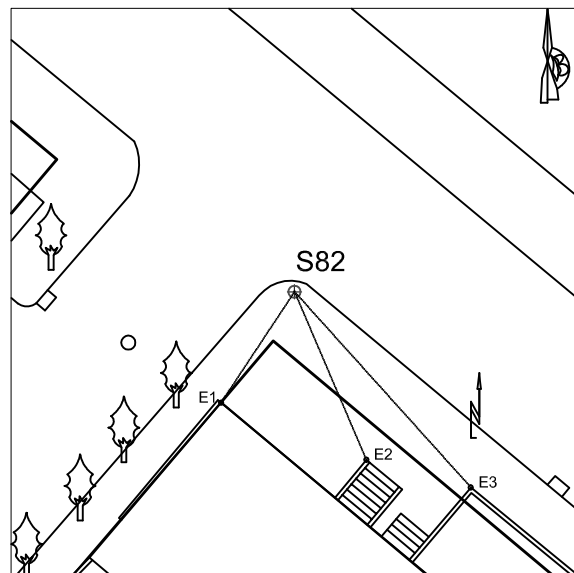
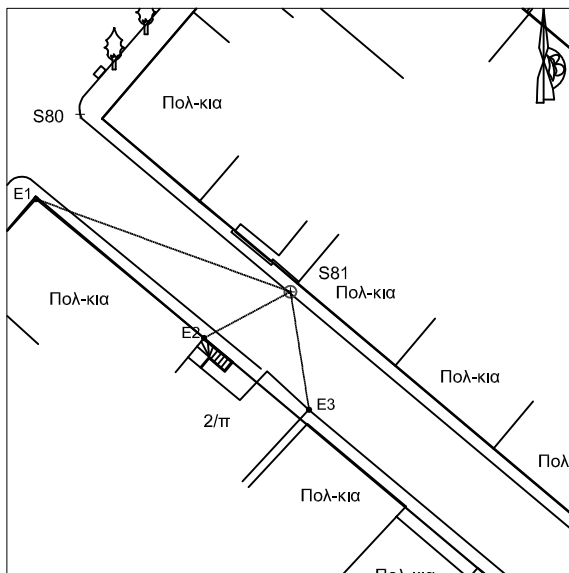

S82
 X= 408815.846
 Y=4501238.616
 H= 22.214
 E1= 6.59
 E2= 9.06
 E3= 13.06

S83
 X= 408841.619
 Y=4501162.319
 H= 22.001
 E1= 6.35
 E2= 8.75
 E3= 11.65

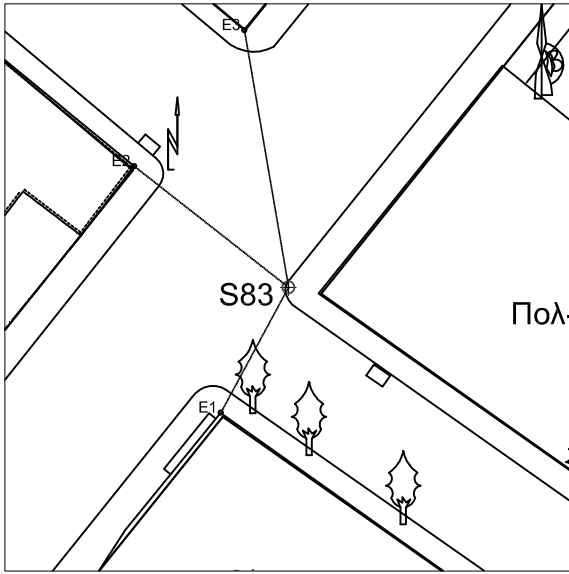

S84
 X= 408895.46
 Y=4501117.496
 H= 21.940
 E1= 7.11
 E2= 9.16
 E3= 6.55

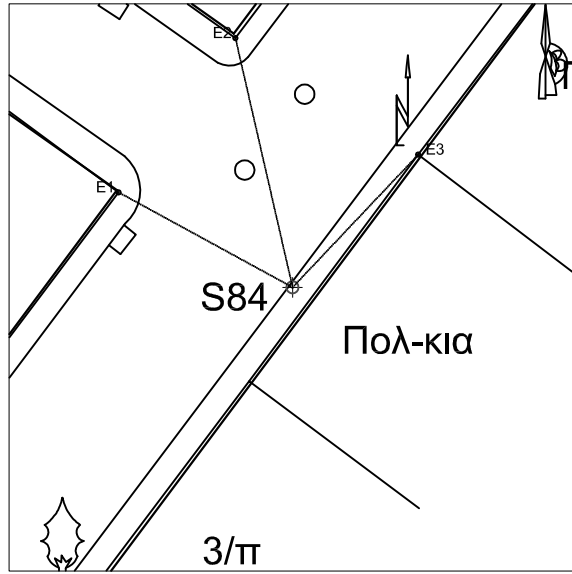

S85
 X= 408870.045
 Y= 4501204.96
 H= 22.342
 E1= 29.92
 E2= 16.93
 E3= 20.2

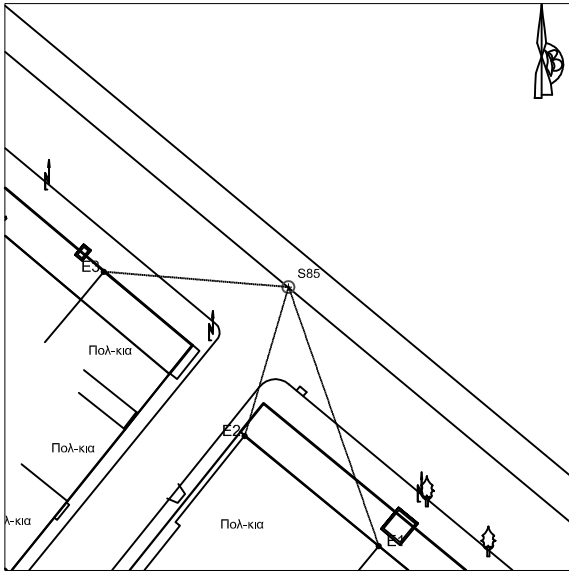

S86
 X= 408871.682
 Y= 4501097.28
 H= 21.574
 E1= 10.49
 E2= 9.49
 E3= 3.71

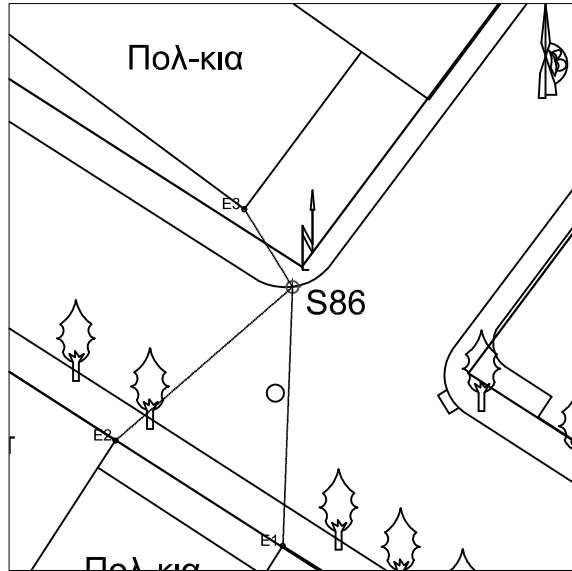

S87
 X= 408898.869
 Y= 4501069.77
 H= 21.552
 E1= 10.63
 E2= 10.57
 E3= 12.02

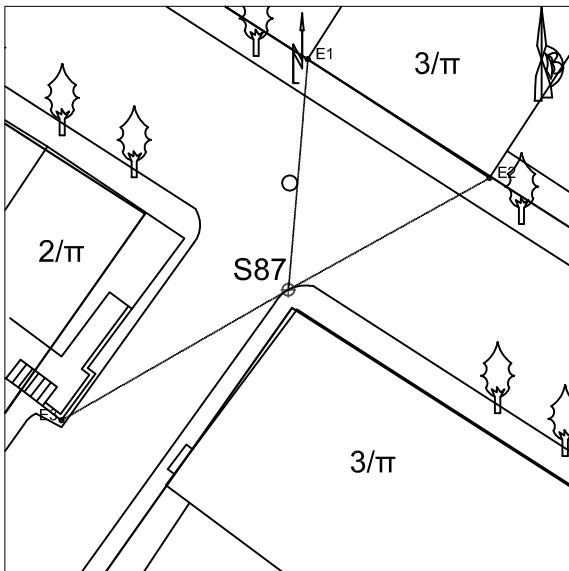

S88
 X= 408927.746
 Y=4501061.513
 H= 21.746
 E1= 9.21
 E2= 13.87
 E3= 11.86

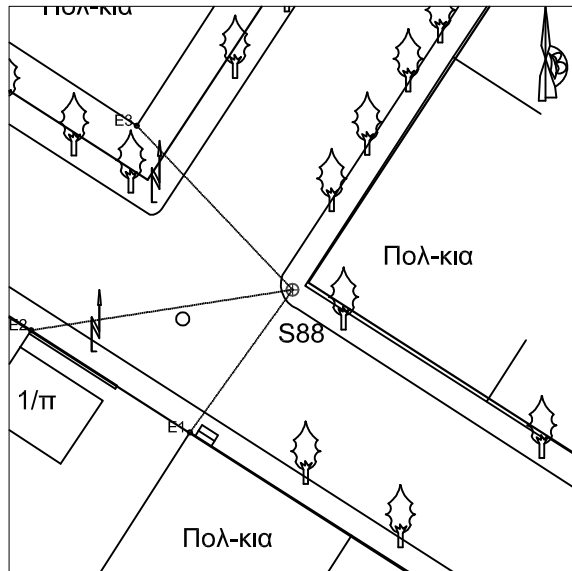

S89
 X= 408876.995
 Y=4501038.378
 H= 21.074
 E1= 10.63
 E2= 7.57
 E3= 9.57

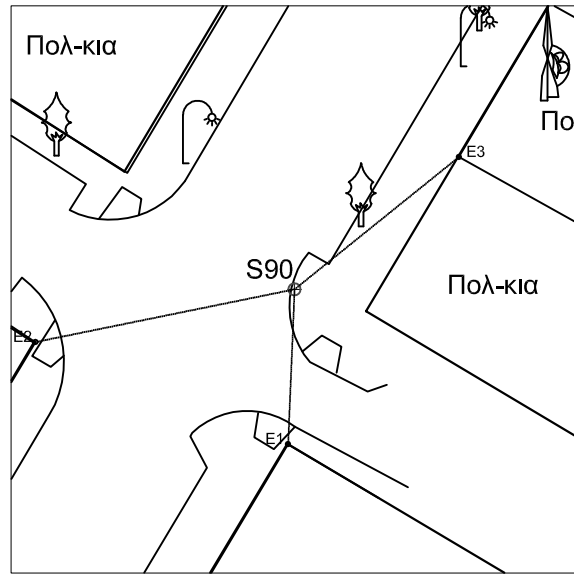
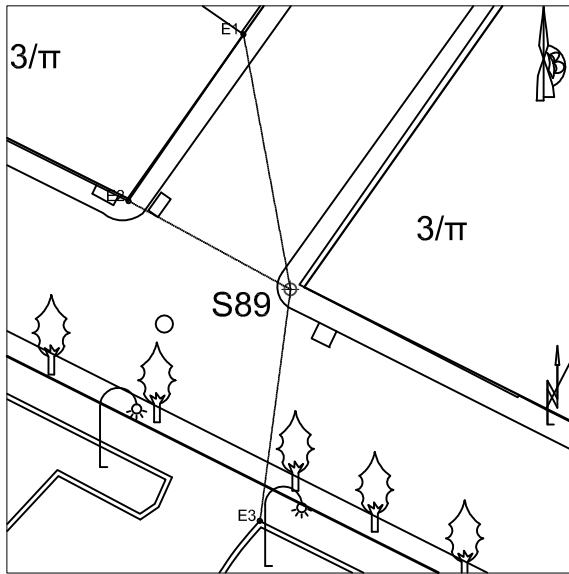

S90
 X= 408980.272
 Y=4501028.308
 H= 22.807
 E1= 8.04
 E2= 13.73
 E3= 10.97

S91
 X= 408944.723
 Y=4501088.987
 H= 22.125
 E1= 13.36
 E2= 8.66
 E3= 2.57

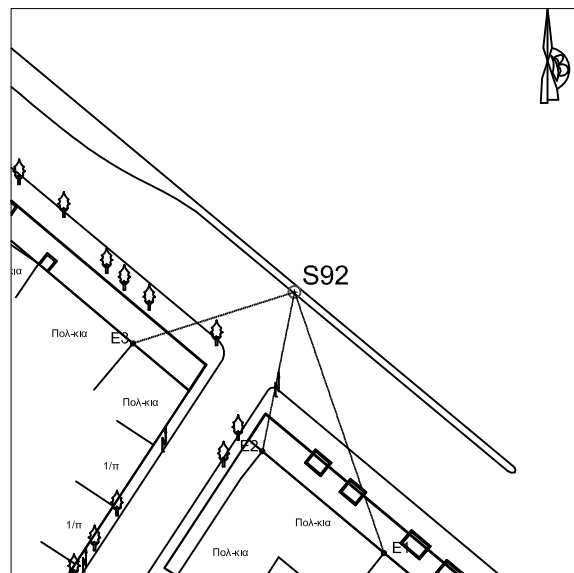
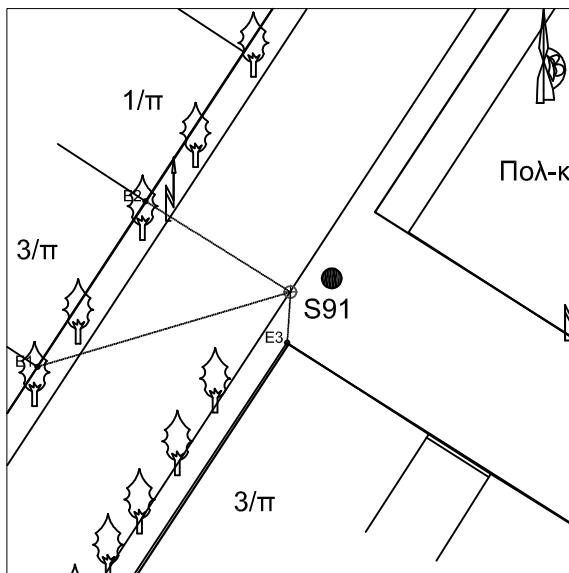

S92
 X= 408966.019
 Y=4501129.065
 H= 22.820
 E1= 36.01
 E2= 21.2
 E3= 22.12

S93
 X= 408918.012
 Y=4501010.161
 H= 21.641
 E1= 10.57
 E2= 14
 E3= 13.39

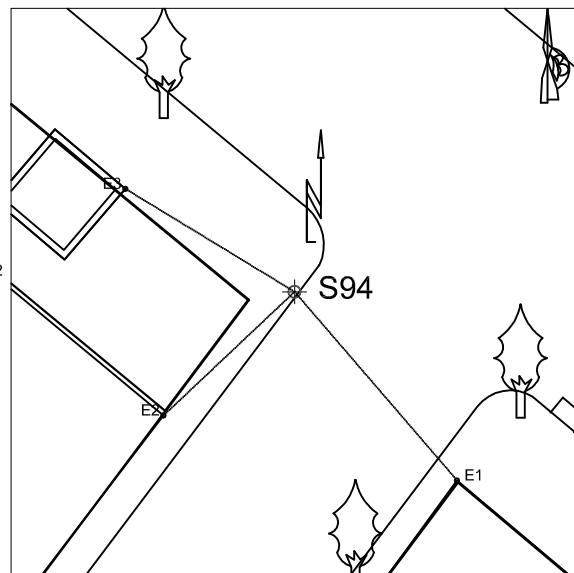
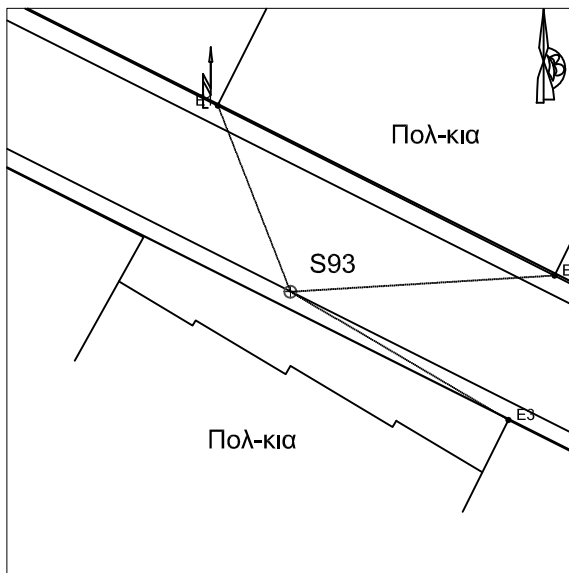

S94
 X= 408915.136
 Y=4501154.169
 H= 22.413
 E1= 7.19
 E2= 5.21
 E3= 5.72

S96
 X= 408999.721
 Y=4501078.249
 H= 23.417
 E1= 16.19
 E2= 16.42
 E3= 2.04

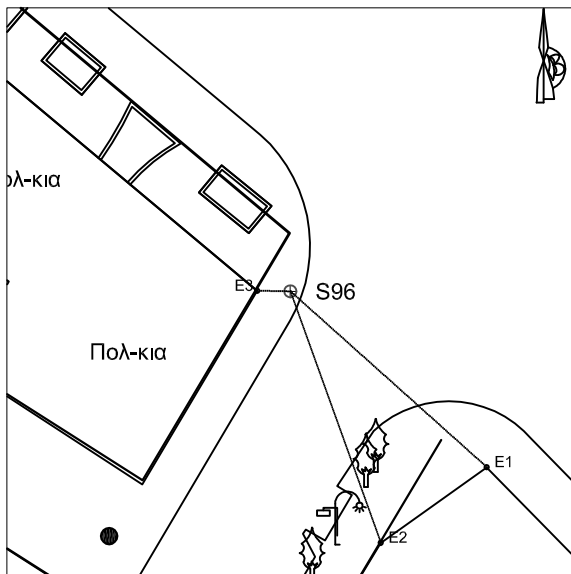

S97
 X= 408951.604
 Y=4500999.313
 H= 22.257
 E1= 14.95
 E2= 13.42
 E3= 6.31

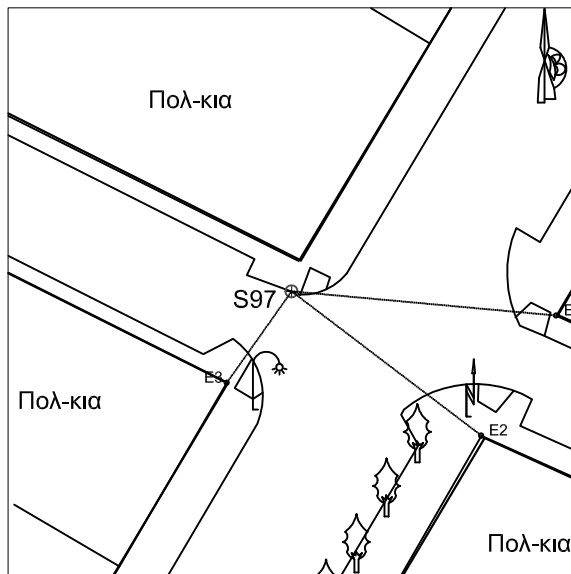

S98
 X= 408906.69
 Y= 4500909.91
 H= 21.226
 E1= 11.78
 E2= 11.83
 E3= 4.6

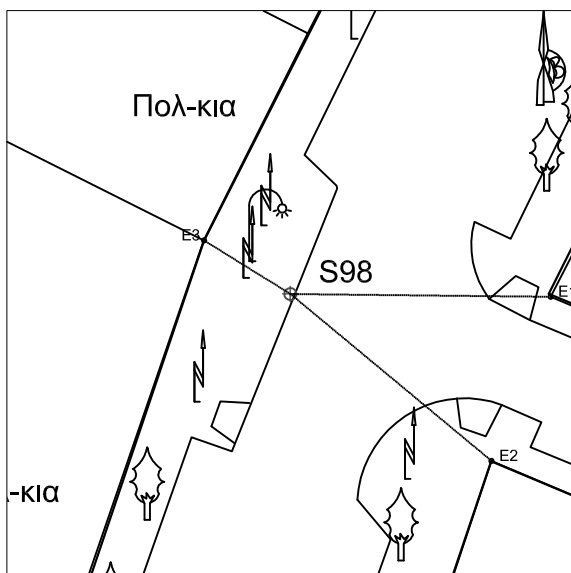

S99
 X= 408867.467
 Y=4500791.778
 H= 19.852
 E1= 15.34
 E2= 11.25
 E3= 6.09

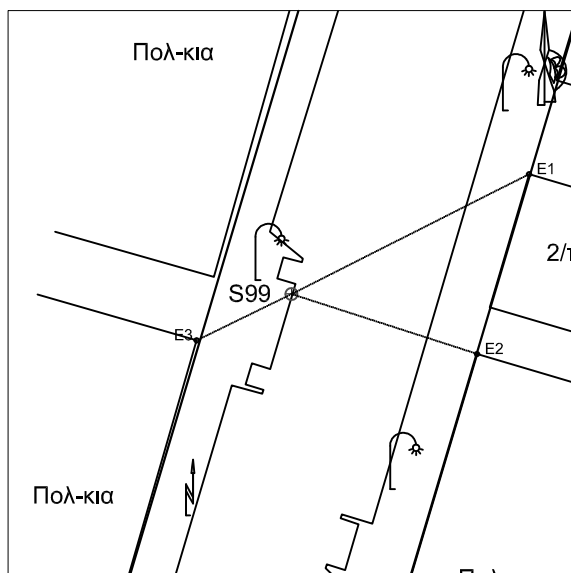

S100
 X= 408854.437
 Y= 4500724.84
 H= 19.226
 E1= 12.41
 E2= 4.77
 E3= 13.85

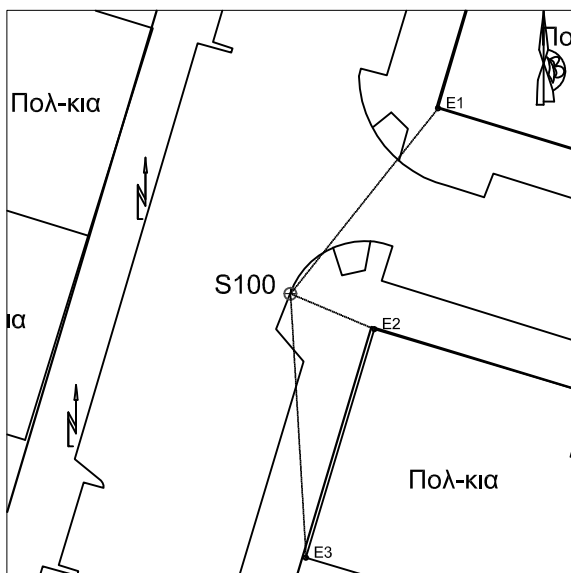

S101
 X= 408833.678
 Y= 4500676.51
 H= 18.595
 E1= 13.4
 E2= 15.7
 E3= 7.83

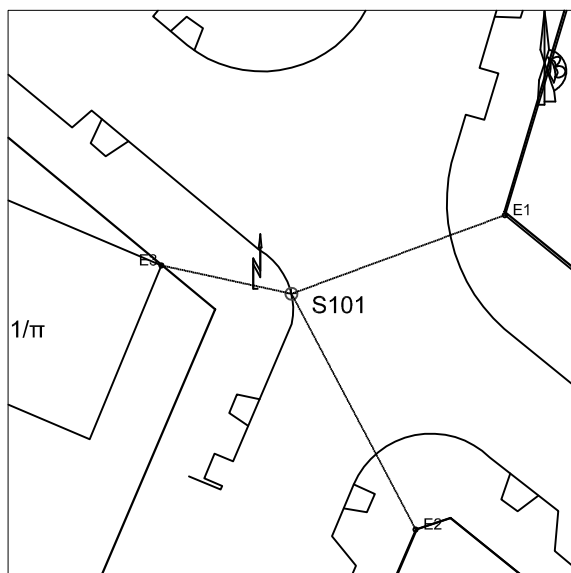

S102
 X= 408630
 Y=4500868.252
 H= 18.160
 E1= 12.97
 E2= 18.68
 E3= 14.95

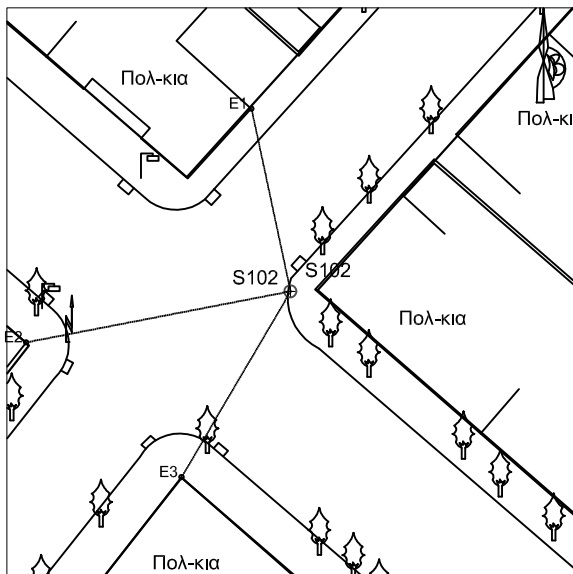

S103
 X= 408646.609
 Y=4500836.941
 H= 17.984
 E1= 14.02
 E2= 16.4
 E3= 10.03

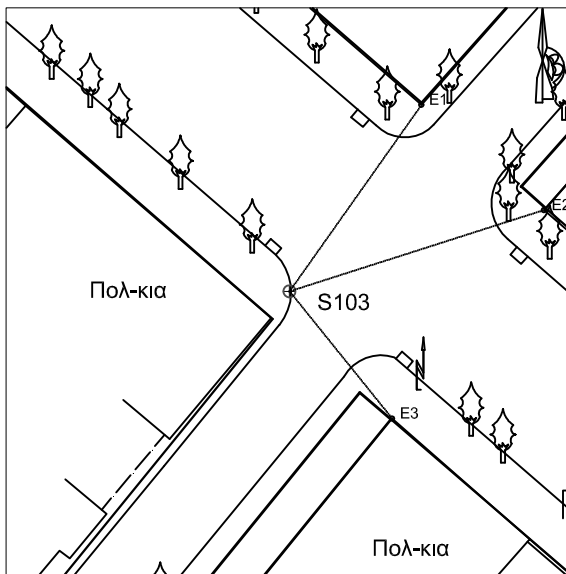

S104
 X= 408693.549
 Y= 4500812.06
 H= 17.863
 E1= 14.13
 E2= 18.75
 E3= 12.85

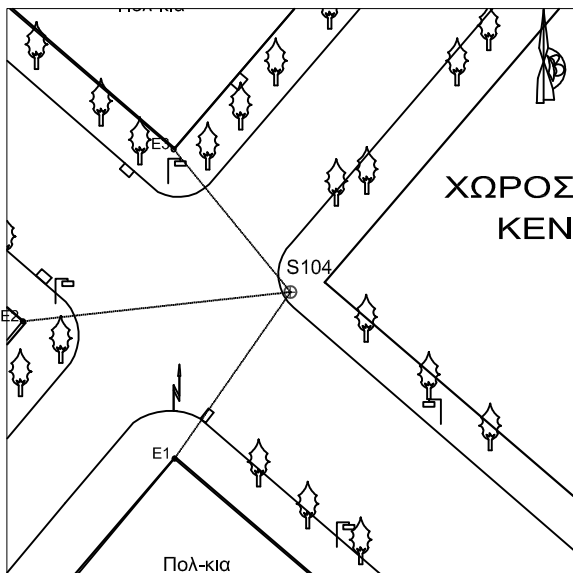

S105
 X= 408739.046
 Y=4500755.841
 H= 18.164
 E1= 15.09
 E2= 16.8
 E3= 12.01

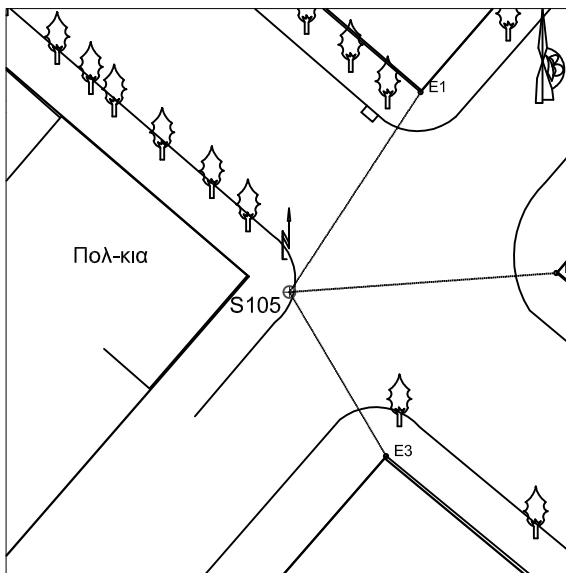

S106
 X= 408786.017
 Y=4500730.592
 H= 18.431
 E1= 30.03
 E2= 14.62
 E3= 5.57

