

ΤΕΥΧΟΣ ΕΞΑΣΦΑΛΙΣΕΩΝ ΣΤΑΣΕΩΝ



ΤΙΤΛΟΣ ΜΕΛΕΤΗΣ :

« ΥΨΟΜΕΤΡΙΚΗ ΜΕΛΕΤΗ ΟΔΩΝ ΤΩΝ Π.Ε 01
(ΑΝΩ ΚΑΙΣΤΡΙ) - Π.Ε. 02 (ΚΑΤΩ ΚΑΙΣΤΡΙ) & Π.Ε. 03
(ΑΚΡΙΤΩΝ) ΤΗΣ ΔΗΜ,ΟΤΙΚΗΣ ΚΟΙΝΟΤΗΤΑΣ
ΑΜΠΕΛΟΚΗΠΩΝ ΤΟΥ ΔΗΜΟΥ ΑΜΠΕΛΟΚΗΠΩΝ
ΜΕΝΕΜΕΝΗΣ »

Σ Π Υ Ρ Ι Δ Ο Π Ο Υ Λ Ο Σ Β. Γ Ρ Η Γ Ο Ρ Ι Ο Σ

Τ η λ. Γ ρ α φ ε ί ο υ : 2310725900

Κ ι ν. 6936865624

F a x : 2310 725900

Η μ ε ρ ο μ η ν ί α : 06/11/2015

S450
X= 409328.31
Y= 4500331.348
H= 16.319

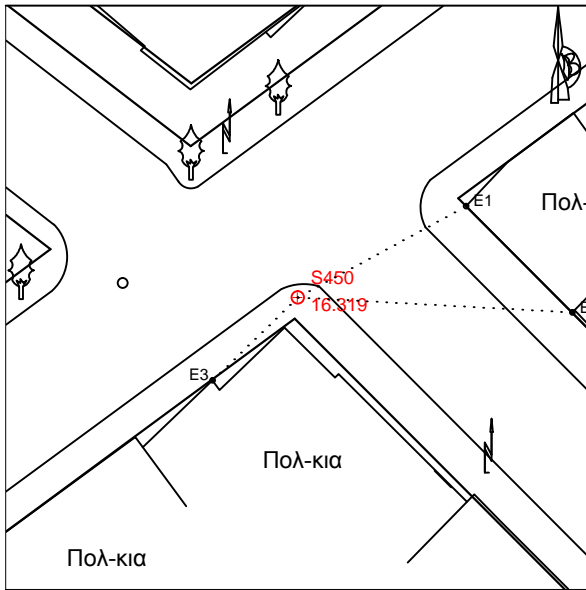

E1= 11.45
E2= 16.46
E3= 7.09

S451
X= 409340.566
Y= 4500351.779
H= 16.510

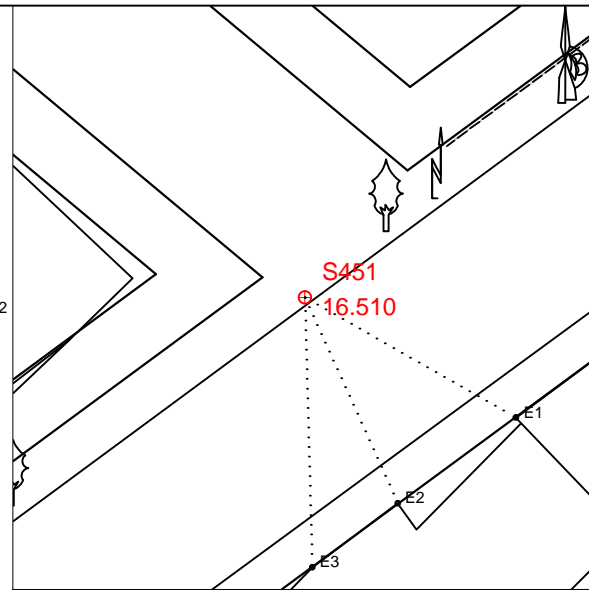

E1= 11.1
E2= 10.32
E3= 12.33

S452
X= 409293.29
Y= 4500305.243
H= 15.576

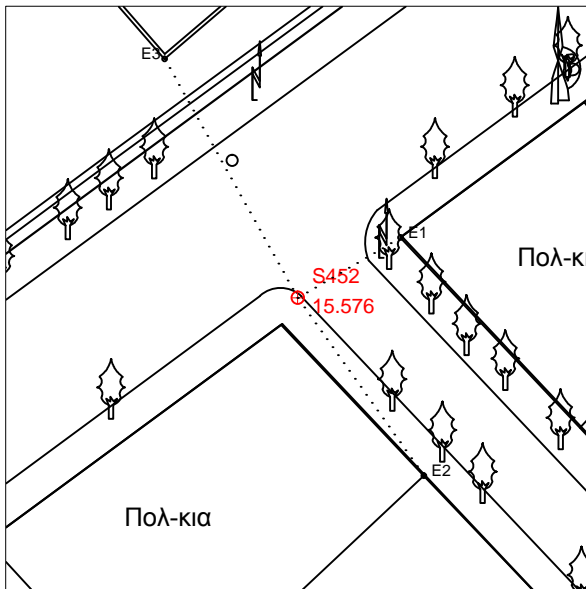

E1= 6.49
E2= 11.86
E3= 14.89

S453
X= 409393.314
Y= 4500280.206
H= 17.473

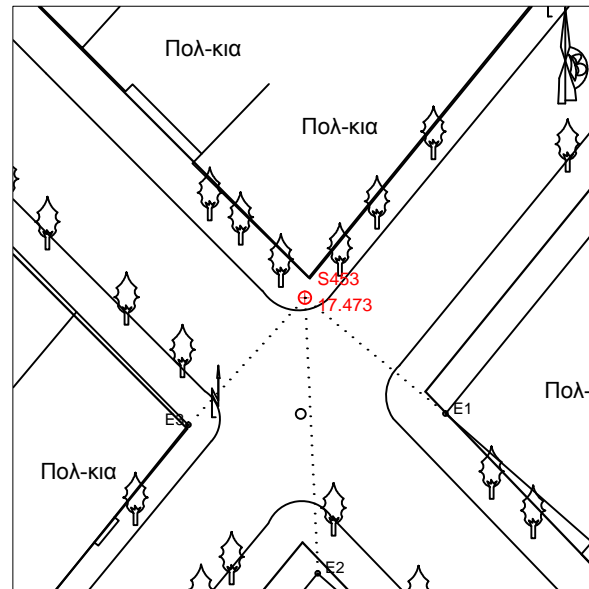

E1= 11.32
E2= 17.13
E3= 10.69

S454
X= 409260.325
Y= 4500280.902
H= 15.356

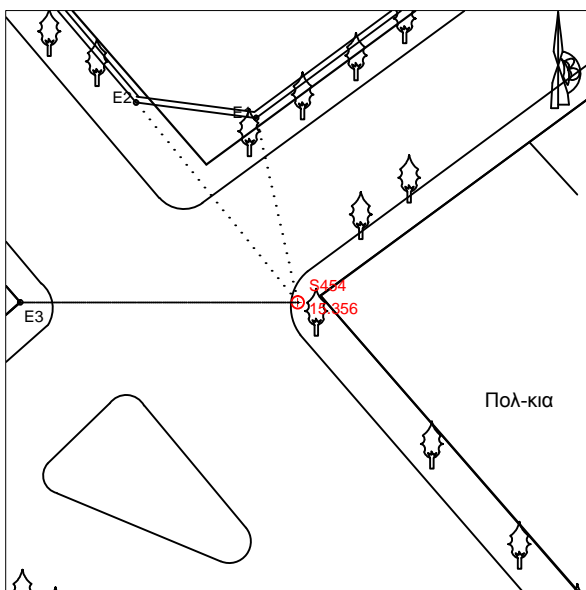

E1= 13.08
E2= 17.8
E3= 19.21

S455
X= 409331.281
Y= 4500271.473
H= 16.213

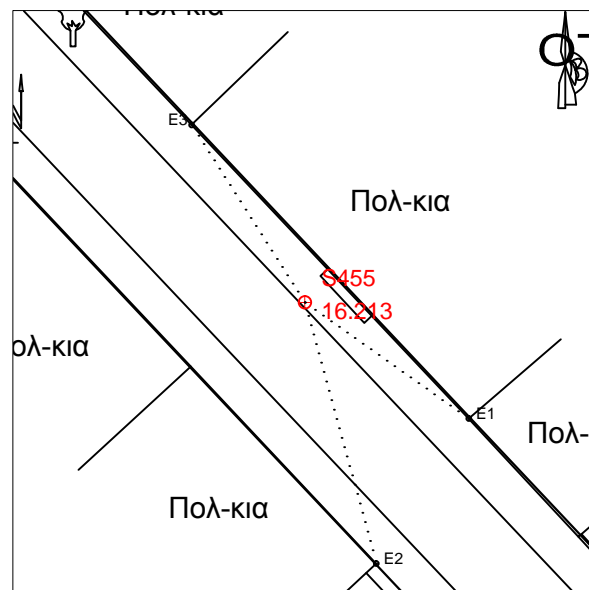

E1= 9.5
E2= 12.81
E3= 9.96

S456
 X= 409361.623
 Y= 4500240.844
 H= 16.372

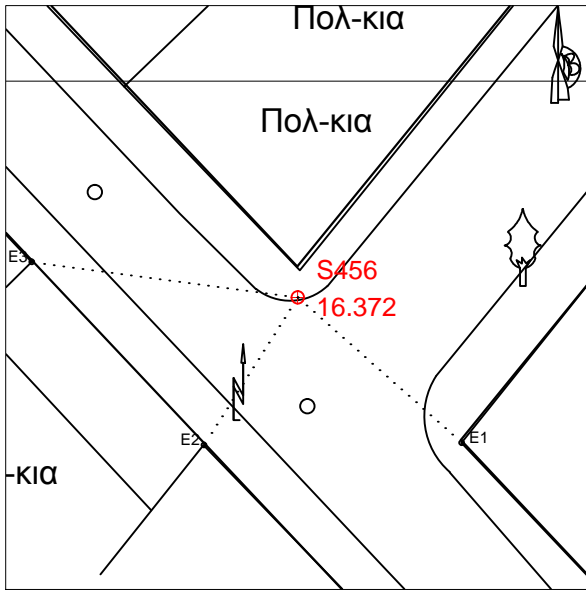

E1= 9.27
 E2= 7.4
 E3= 11.35

S457
 X= 409370.341
 Y= 4500222.701
 H= 15.974

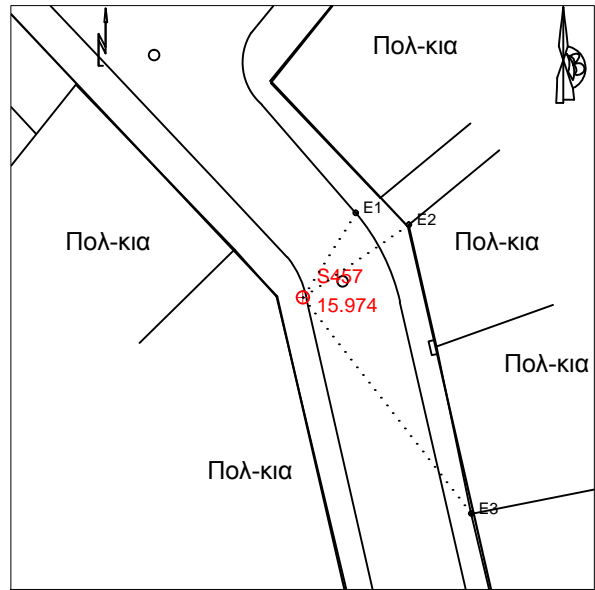

E1= 5.57
 E2= 7.19
 E3= 15.32

S458
 X= 409428.352
 Y= 4500308.909
 H= 19.346

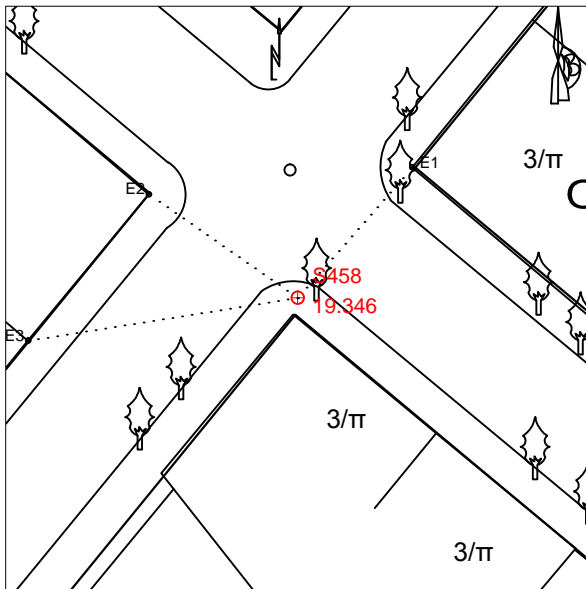

E1= 9.14
 E2= 9.55
 E3= 14.37

S459
 X= 409419.795
 Y= 4500240.642
 H= 17.749

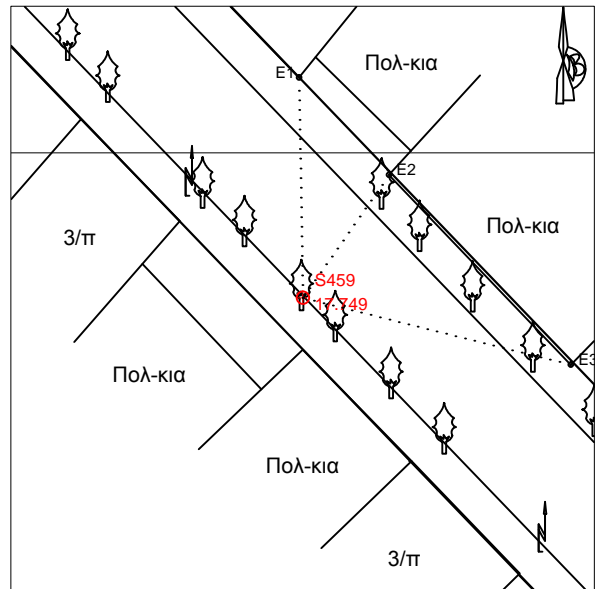

E1= 14.22
 E2= 9.7
 E3= 17.84

S460
 X= 409454.539
 Y= 4500214.793
 H= 16.762

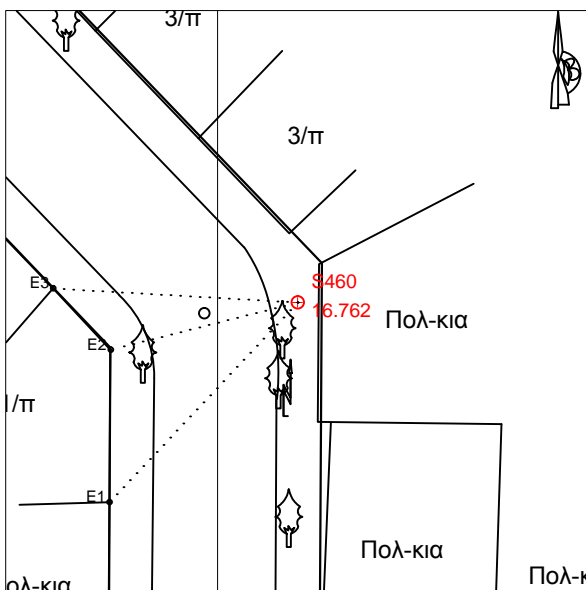

E1= 15.59
 E2= 10.96
 E3= 13.91

S461
 X= 409442.888
 Y= 4500183.859
 H= 16.440

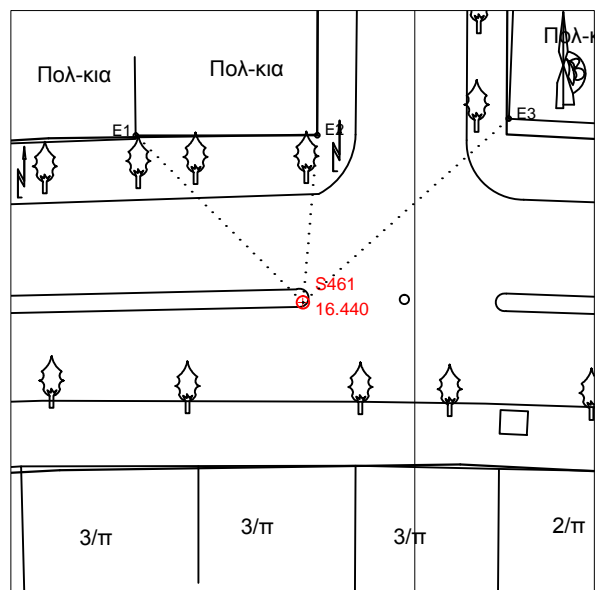

E1= 14.94
 E2= 10.62
 E3= 17.48

S462
 X= 409448.3
 Y= 4500346.708
 H= 21.367

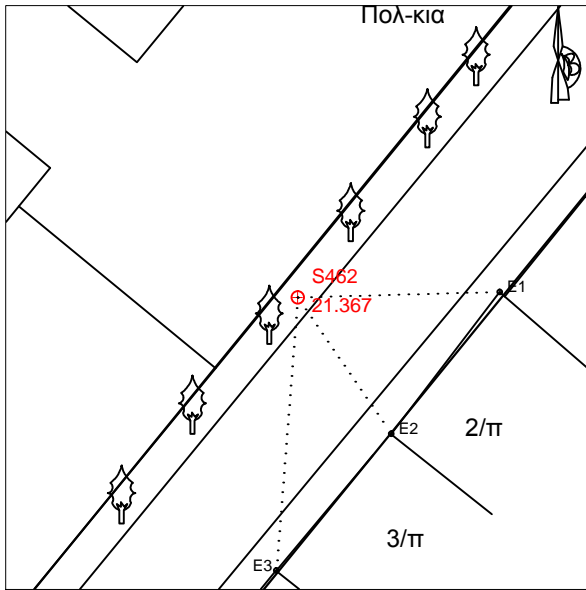

E1= 11.37
 E2= 9.3
 E3= 15.41

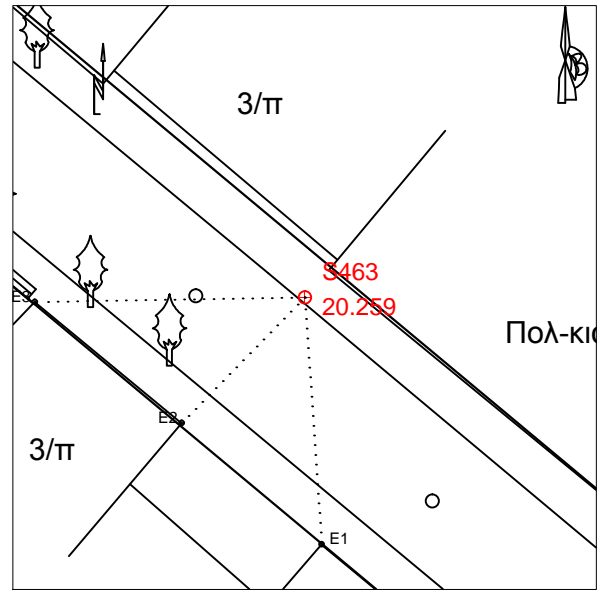

S463
 X= 409462.75
 Y= 4500289.879
 H= 20.259

E1= 11.33
 E2= 8.05
 E3= 12.37

S464
 X= 409387.45
 Y= 4500342.891
 H= 18.101

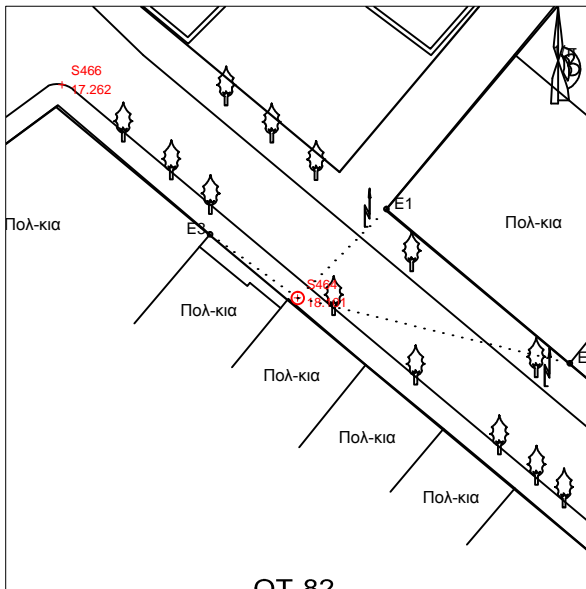

E1= 10.51
 E2= 23.41
 E3= 9.06

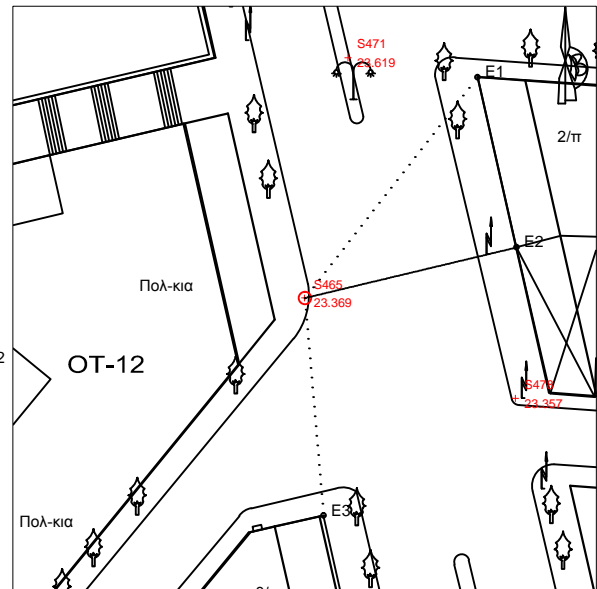

S465
 X= 409476.83
 Y= 4500382.127
 H= 23.369

E1= 24.55
 E2= 19.06
 E3= 19.1

S466
 X= 409367.754
 Y= 4500360.726
 H= 17.262

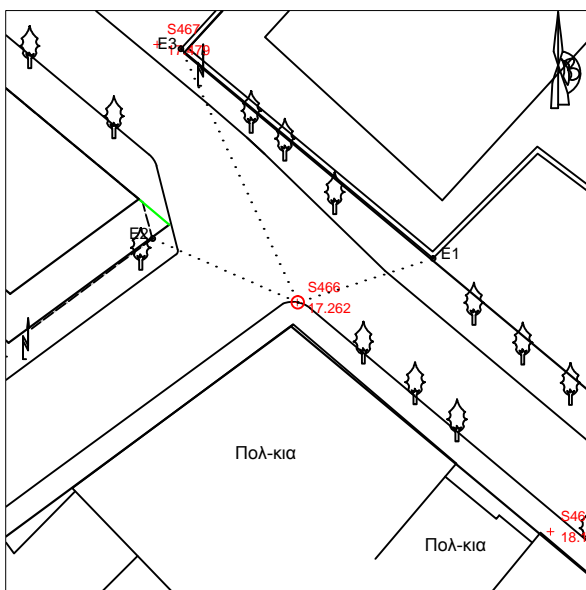

E1= 11.1
 E2= 12.33
 E3= 21.73

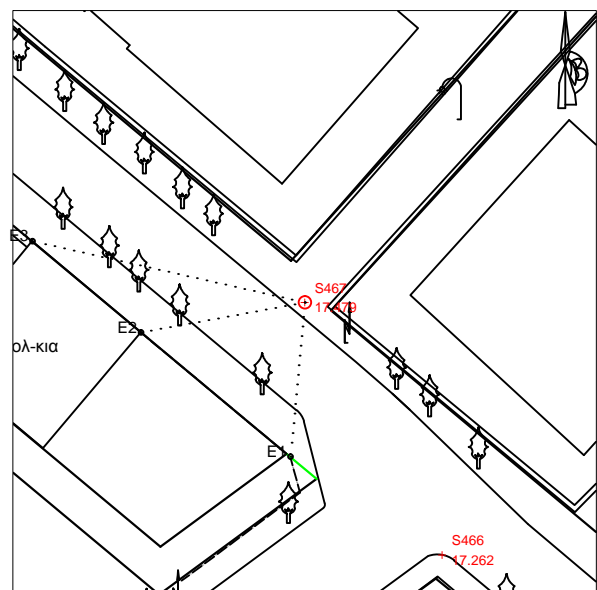

S467
 X= 409356.836
 Y= 4500380.795
 H= 17.479

E1= 12.32
 E2= 13.24
 E3= 22.2

S468
X= 409378.559
Y= 4500406.765
H= 18.722

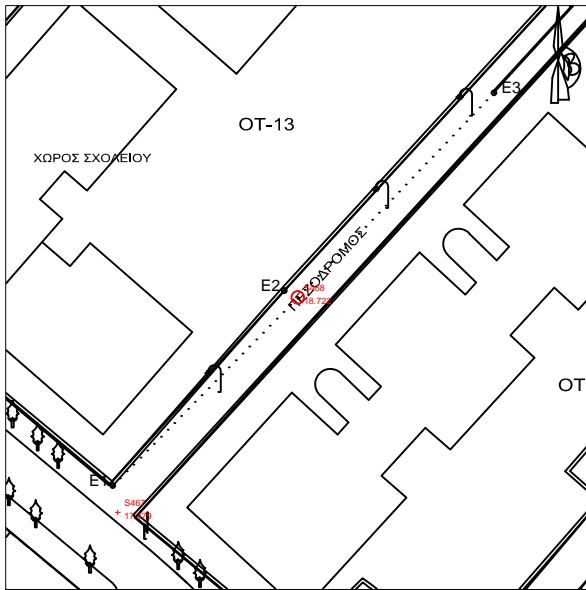

E1= 31.92
E2= 1.8
E3= 34.31

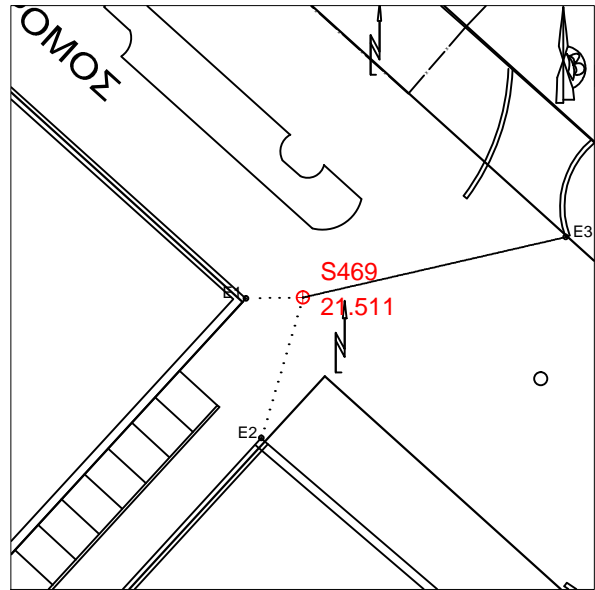

S469
X= 409422.889
Y= 4500454.86
H= 21.511

E1= 2.56
E2= 6.6
E3= 12.17

S470
X= 409427.572
Y= 4500390.252
H= 18.624

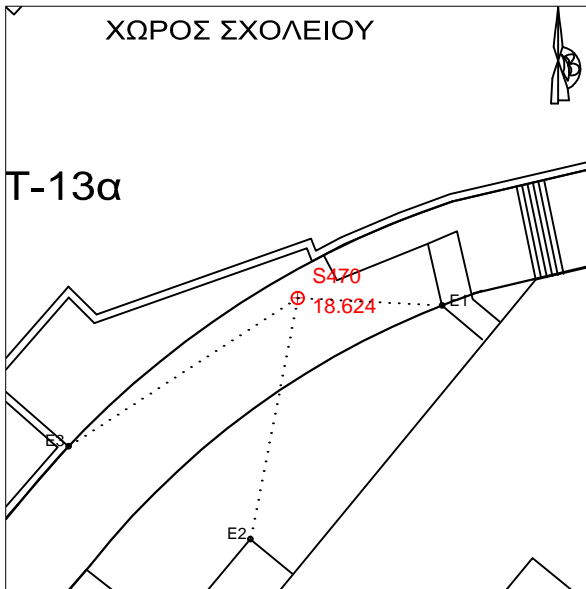

E1= 7.67
E2= 13.02
E3= 14.47

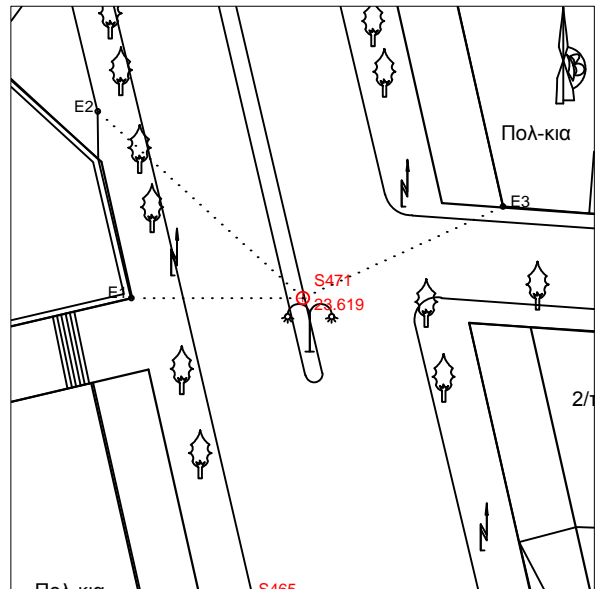

S471
X= 409480.626
Y= 4500403.162
H= 23.619

E1= 11.68
E2= 18.87
E3= 14.98

S472
X= 409464.71
Y= 4500435.503
H= 23.417

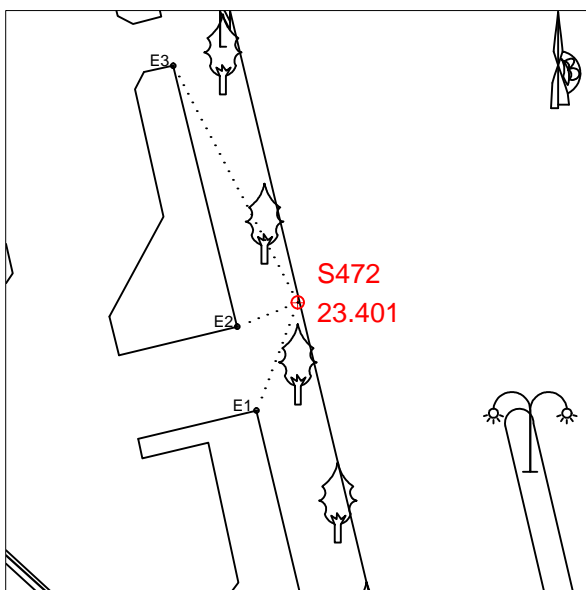

E1= 4.72
E2= 2.66
E3= 10.92

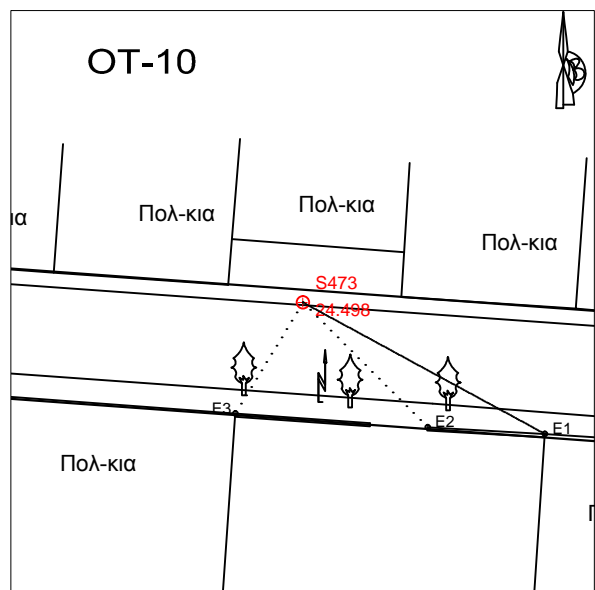

S473
X= 409547.277
Y= 4500404.715
H= 24.498

E1= 16.99
E2= 10.89
E3= 8

S474
X= 409492.211
Y= 4500437.74
H= 23.319

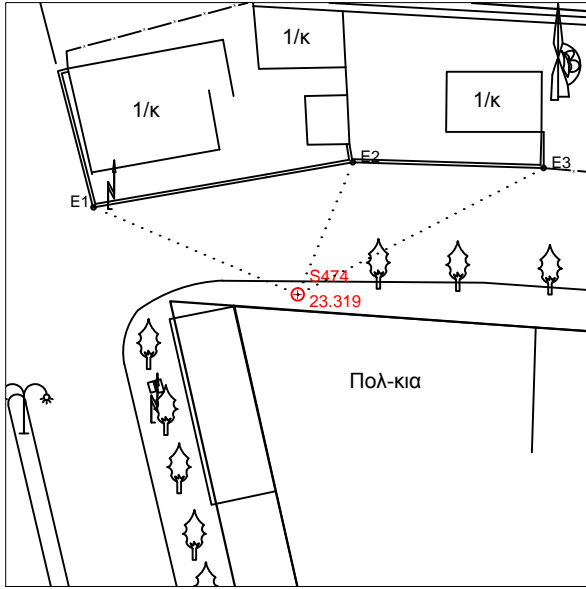

E1= 14.61
E2= 9.43
E3= 18.2

S475
X= 409444.17
Y= 4500442.309
H= 22.307

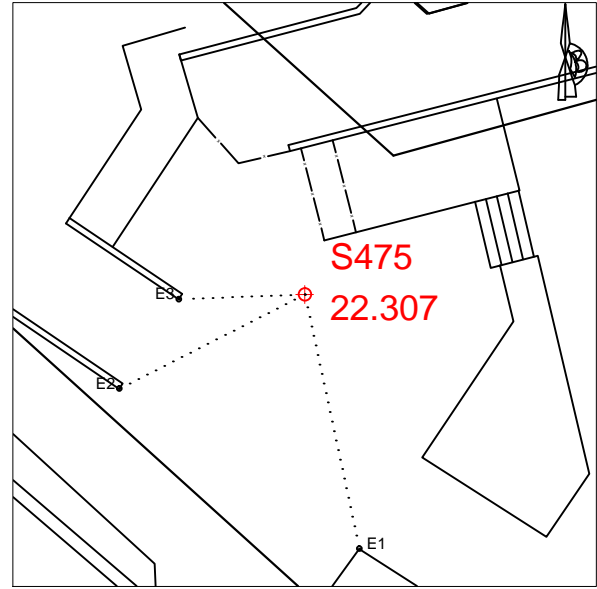

E1= 8.14
E2= 6.52
E3= 3.95

S476
X= 409390.437
Y= 4500496.874
H= 21.357

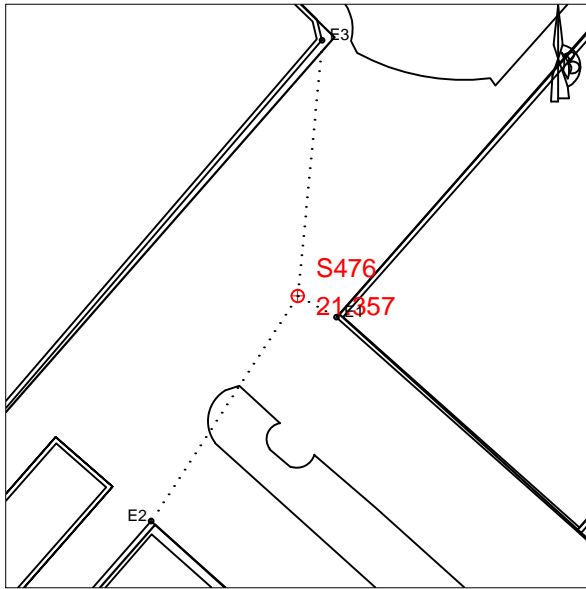

E1= 1.9
E2= 11.52
E3= 11.02

S477
X= 409496.642
Y= 4500332.351
H= 23.617

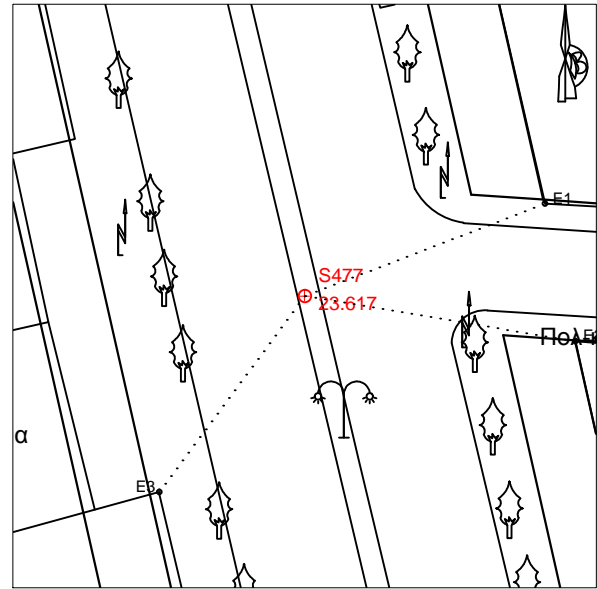

E1= 14.93
E2= 15.92
E3= 14.16

S478
X= 409495.292
Y= 4500373.338
H= 23.357

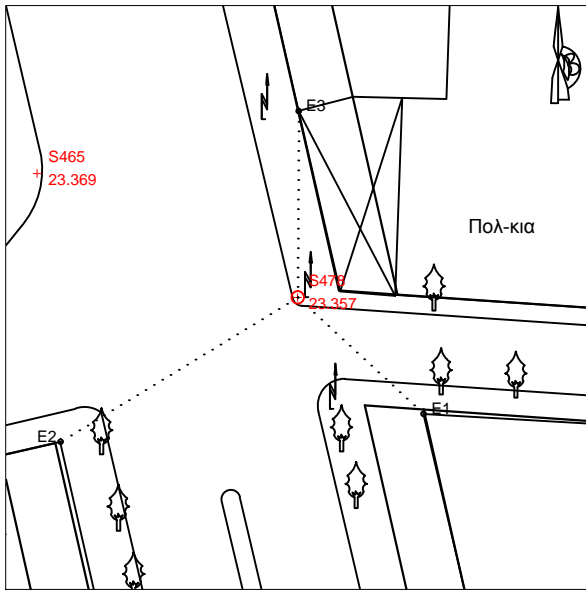

E1= 12.18
E2= 19.7
E3= 13.22

S479
X= 409542.877
Y= 4500364.447
H= 24.857

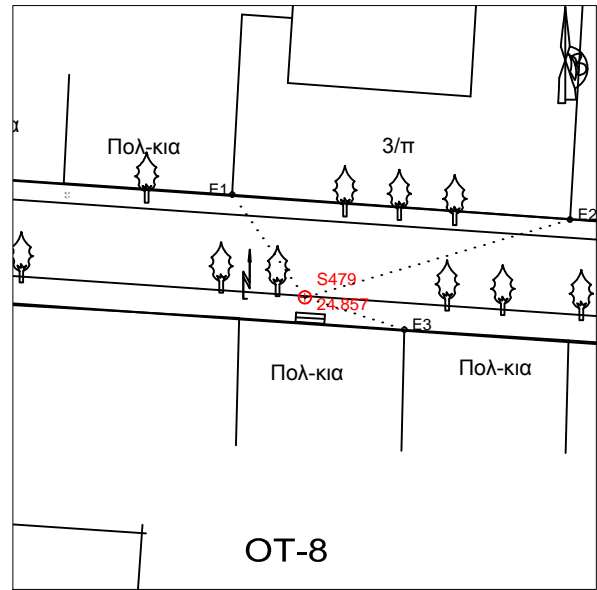

E1= 8.19
E2= 18.01
E3= 6.83

S480
 X= 409580.293
 Y= 4500332.343
 H= 27.180

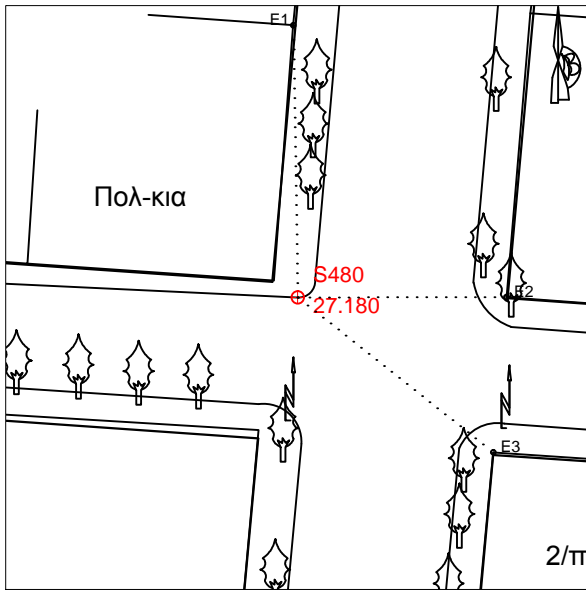

E1= 13.86
 E2= 10.64
 E3= 12.71

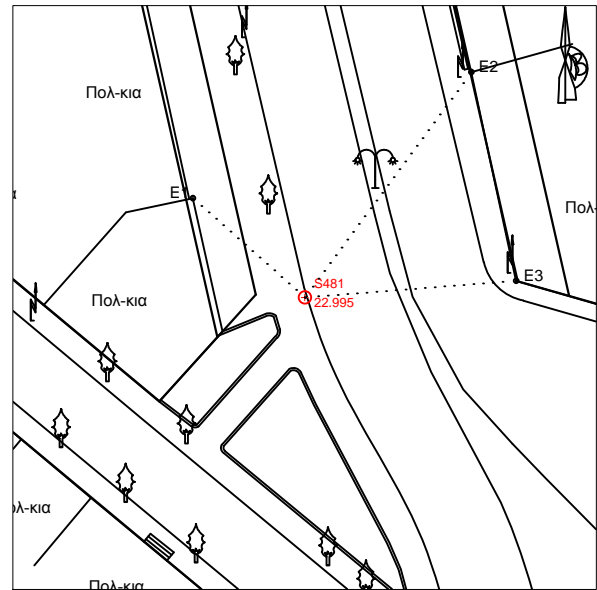

S481
 X= 409501.182
 Y= 4500279.375
 H= 22.995

E1= 12.73
 E2= 23.86
 E3= 18.07

S482
 X= 409535.478
 Y= 4500267.215
 H= 23.149

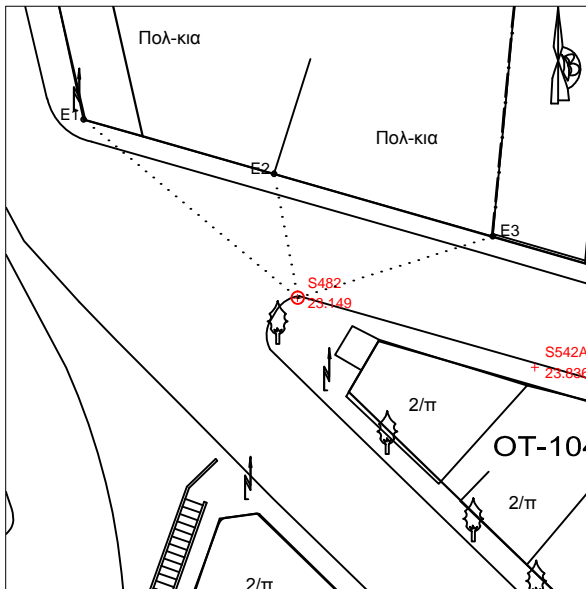

E1= 21.2
 E2= 9.6
 E3= 15.55

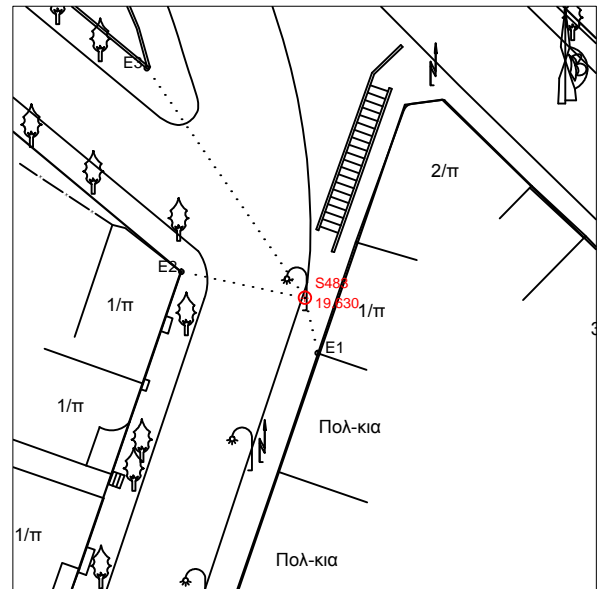

S483
 X= 409521.939
 Y= 4500235.756
 H= 19.630

E1= 4.31
 E2= 9.59
 E3= 21.18

S484
 X= 409496.557
 Y= 4500189.463
 H= 17.421

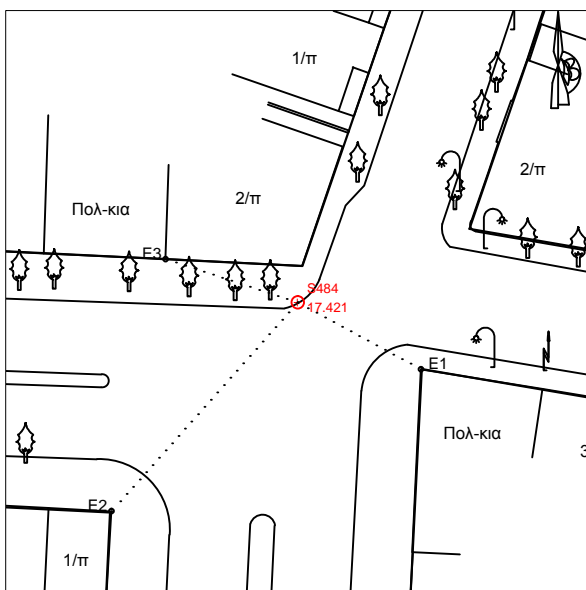

E1= 11.54
 E2= 23
 E3= 11.44

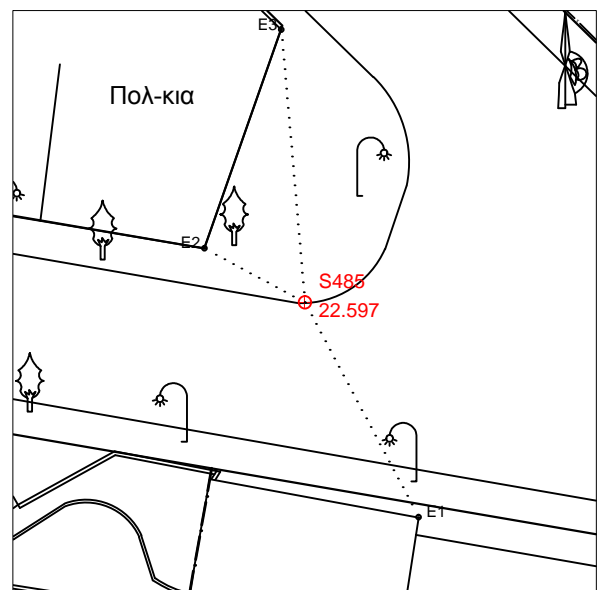

S485
 X= 409590.908
 Y= 4500179.724
 H= 22.597

E1= 13.54
 E2= 6.35
 E3= 15.25

S486
X= 409491.681
Y= 4500123.319
H= 15.858

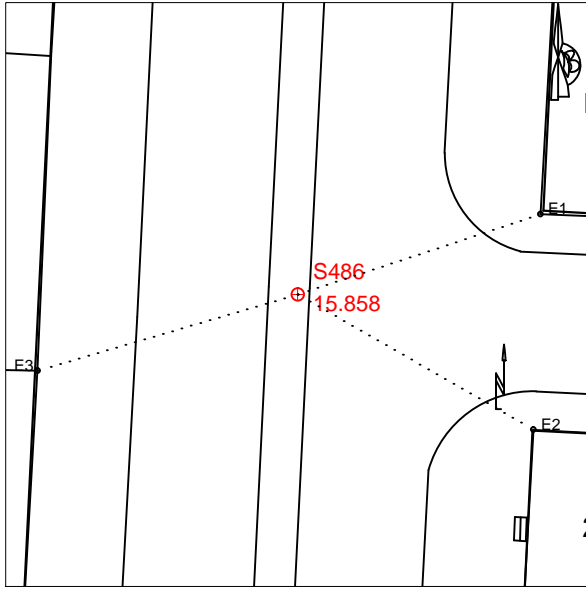

E1= 12.8
E2= 13.6
E3= 13.56

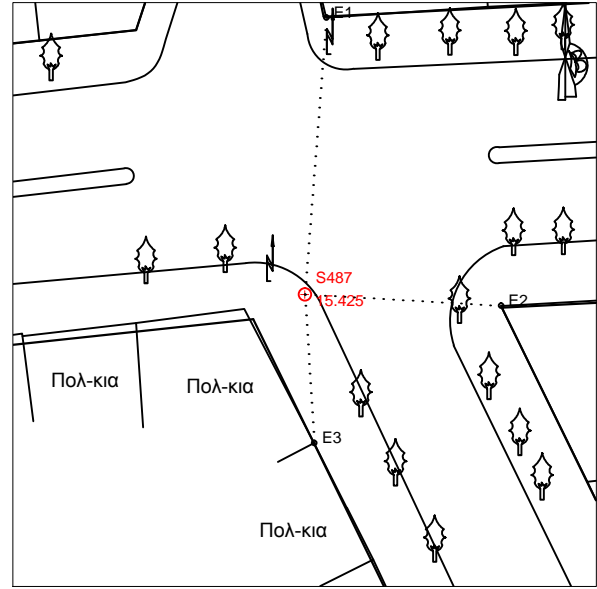

S487
X= 409382.837
Y= 4500172.562
H= 15.425

E1= 19.45
E2= 13.78
E3= 10.42

S488
X= 409400.219
Y= 4500128.624
H= 14.327

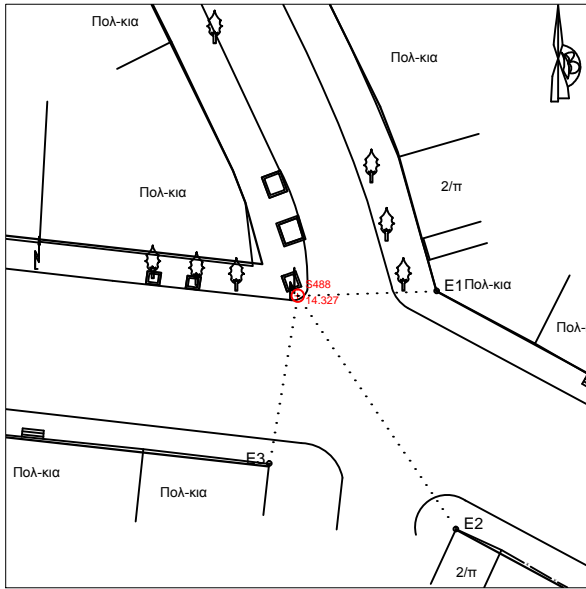

E1= 13.89
E2= 28.14
E3= 16.98

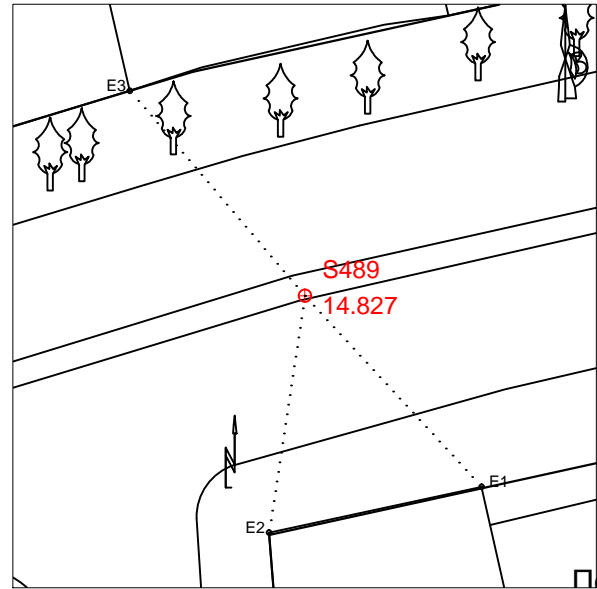

S489
X= 409276.388
Y= 4500164.255
H= 14.827

E1= 11.65
E2= 10.72
E3= 12.07

S490
X= 409267.745
Y= 4500133.164
H= 14.234

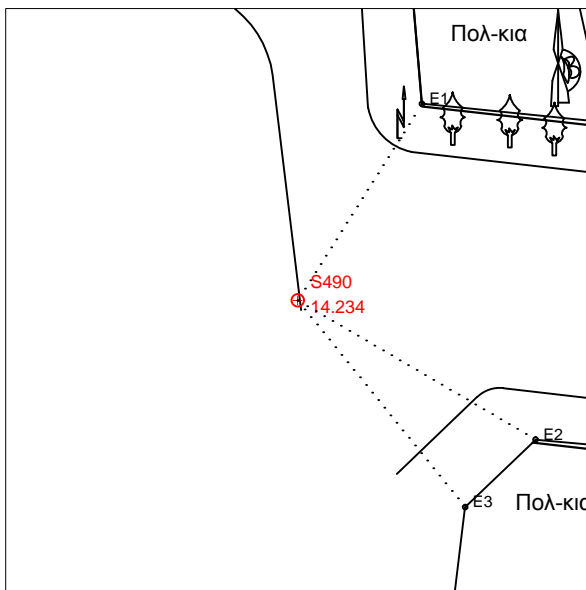

E1= 14.46
E2= 17.14
E3= 16.55

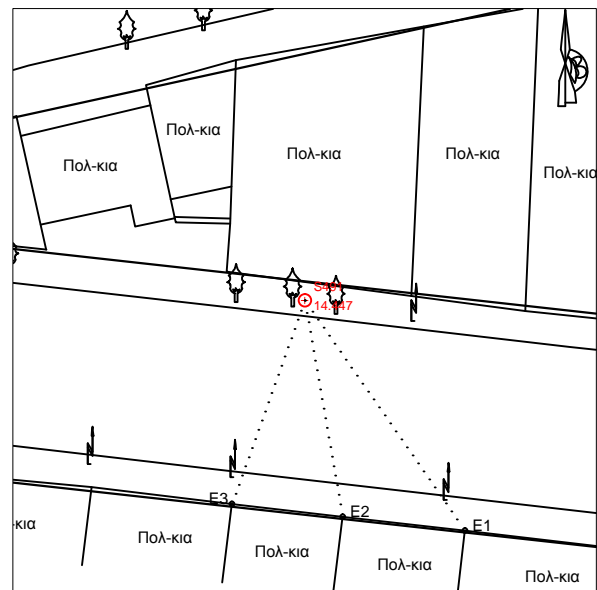

S491
X= 409309.164
Y= 4500139.833
H= 14.447

E1= 24.17
E2= 18.93
E3= 18.63

S492
X= 409341.961
Y= 4500120.188
H= 14.628

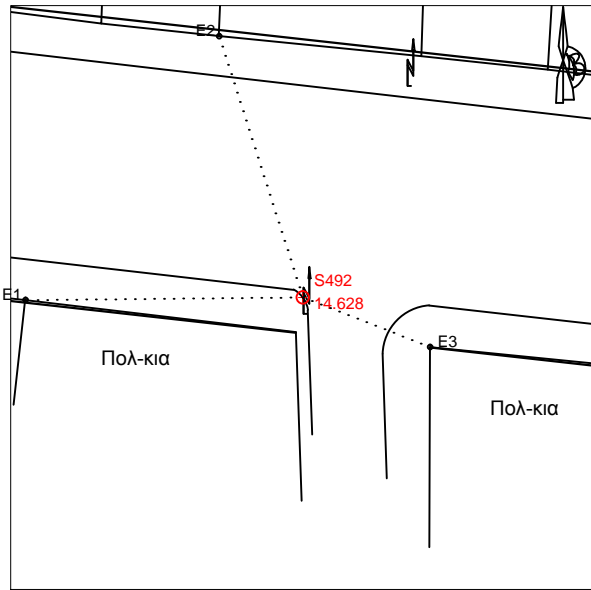

E1= 18.99
E2= 18.78
E3= 9.38

S493
X= 409479.936
Y= 4500073.34
H= 14.280

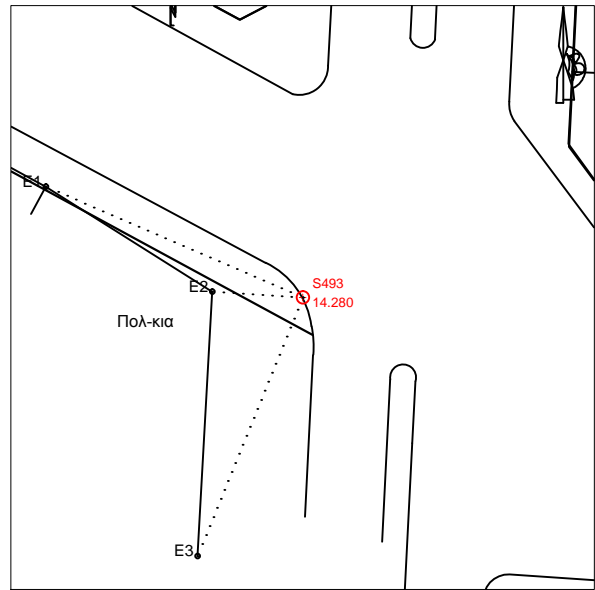

E1= 23.09
E2= 7.48
E3= 23.05

S494
X= 409529.324
Y= 4500045.126
H= 15.134

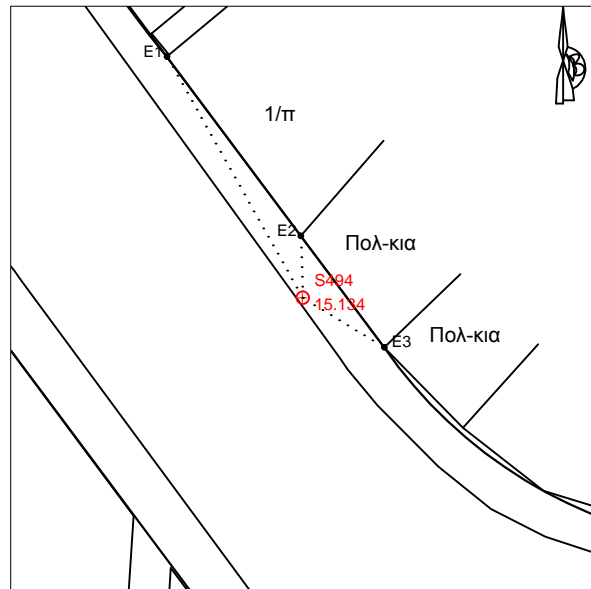

E1= 18.4
E2= 4.12
E3= 6.35

S495
X= 409544.82
Y= 4499993.616
H= 14.688

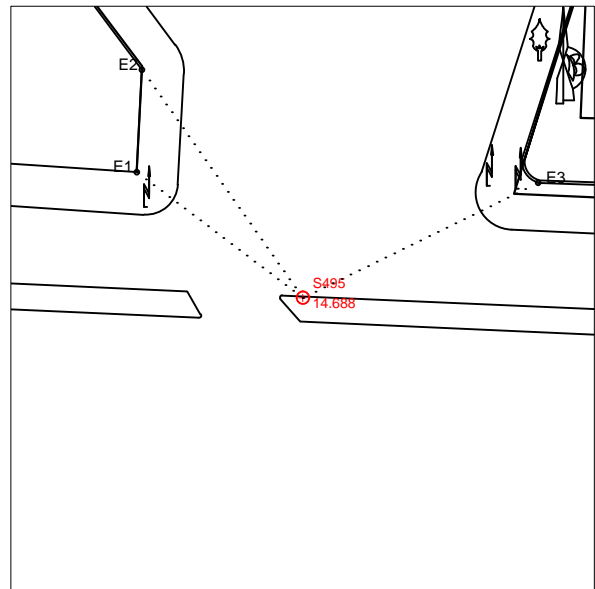

E1= 16.37
E2= 21.94
E3= 20.61

S496
X= 409573.261
Y= 4500049.916
H= 16.399

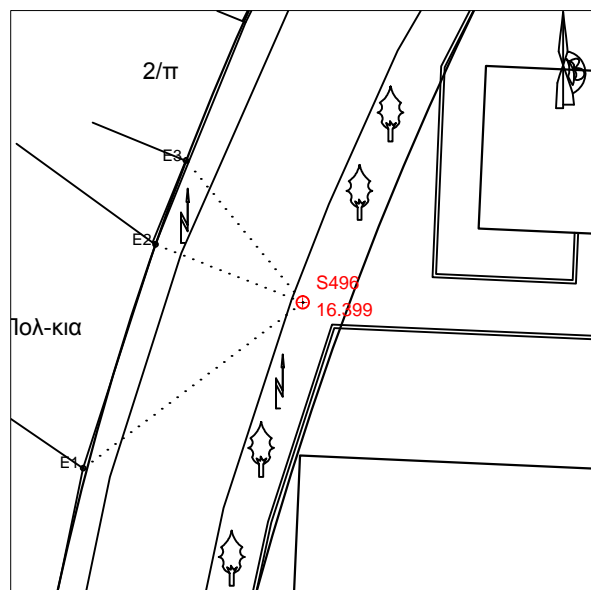

E1= 16.32
E2= 9.38
E3= 10.9

S497
X= 409606.127
Y= 4499990.733
H= 16.592

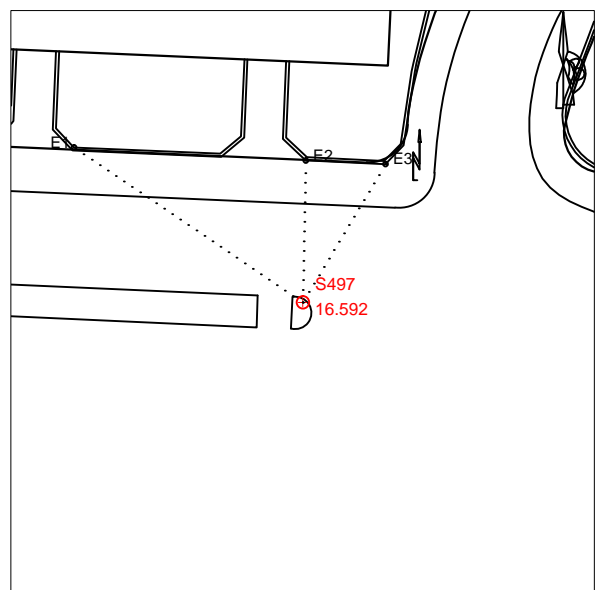

E1= 17.62
E2= 9.06
E3= 10.28

S498
X= 409586.556
Y= 4500074.355
H= 17.228

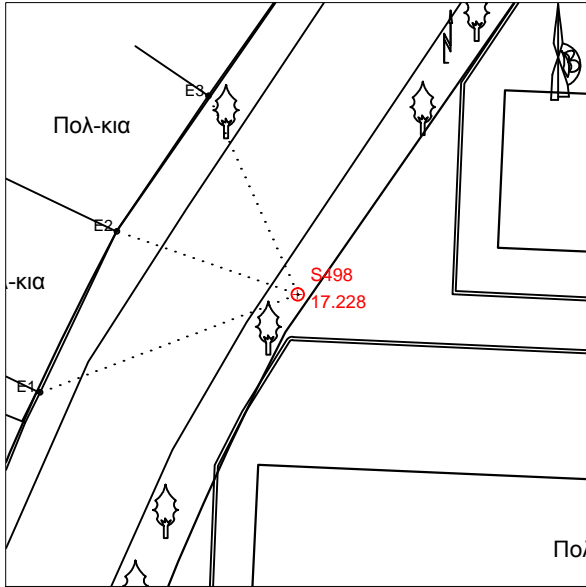

E1= 16.86
E2= 11.73
E3= 13.32

S499
X= 409601.976
Y= 4500099.889
H= 18.547

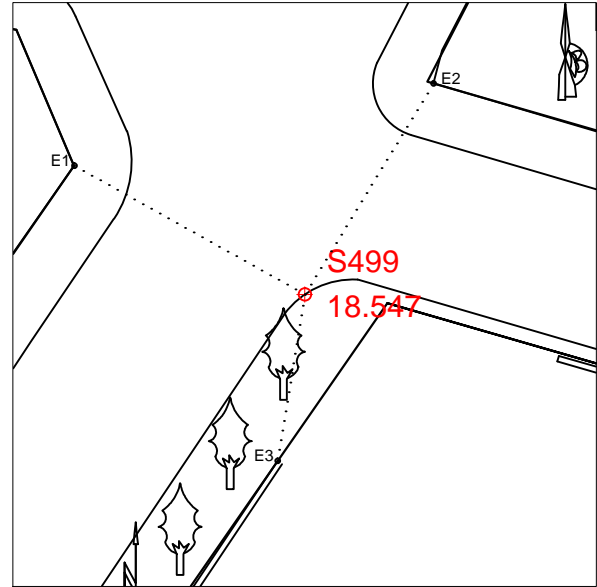

E1= 9.44
E2= 8.84
E3= 6.03

S500
X= 409572.492
Y= 4500121.723
H= 17.627

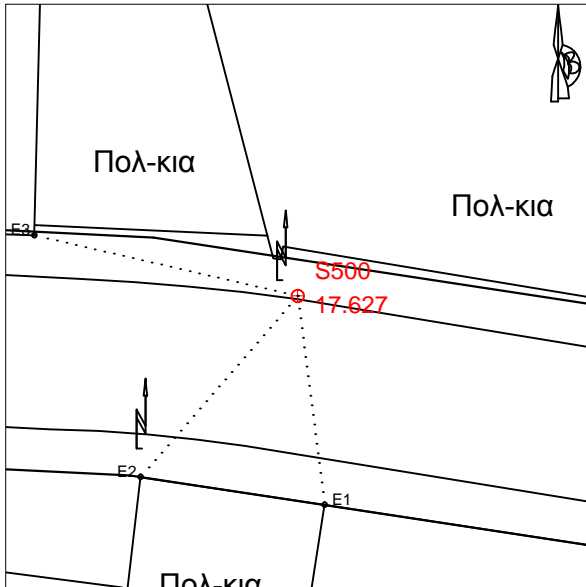

E1= 9.71
E2= 11.06
E3= 12.46

S501
X= 409616.12
Y= 4500127.429
H= 19.532

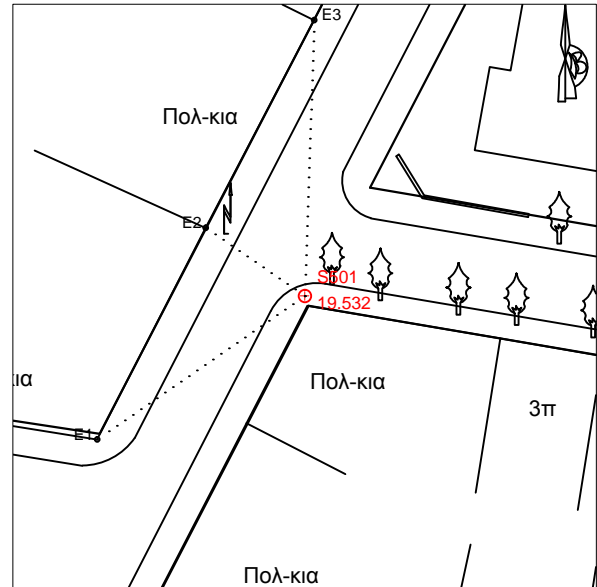

E1= 15.93
E2= 7.58
E3= 17.42

S502
X= 409661.304
Y= 4500089.66
H= 19.688

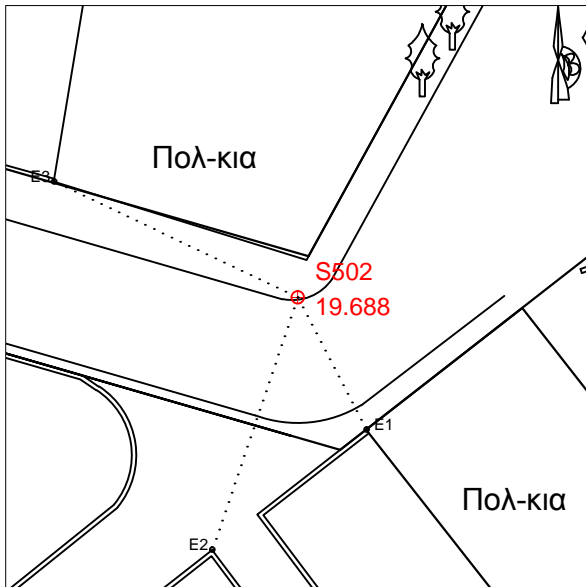

E1= 6.73
E2= 12.03
E3= 12.18

S503
X= 409682.518
Y= 4500115.95
H= 21.302

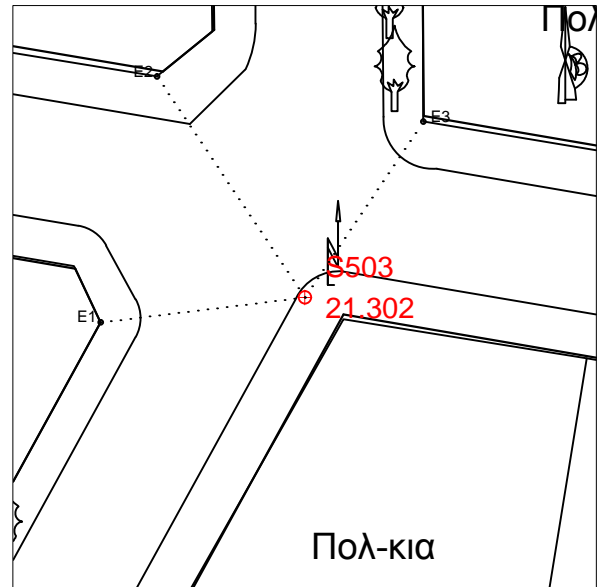

E1= 7.87
E2= 10.17
E3= 8.12

S504
 X= 409629.517
 Y= 4500175.796
 H= 23.580

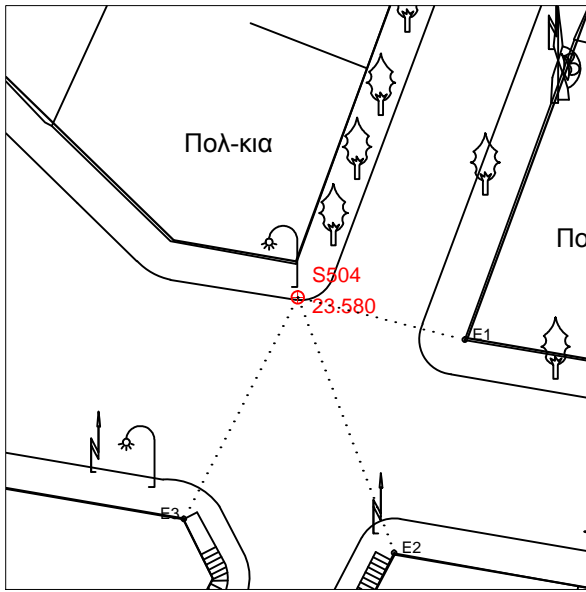

E1= 9.18
 E2= 14.55
 E3= 13.28

S505
 X= 409685.708
 Y= 4500153.924
 H= 24.146

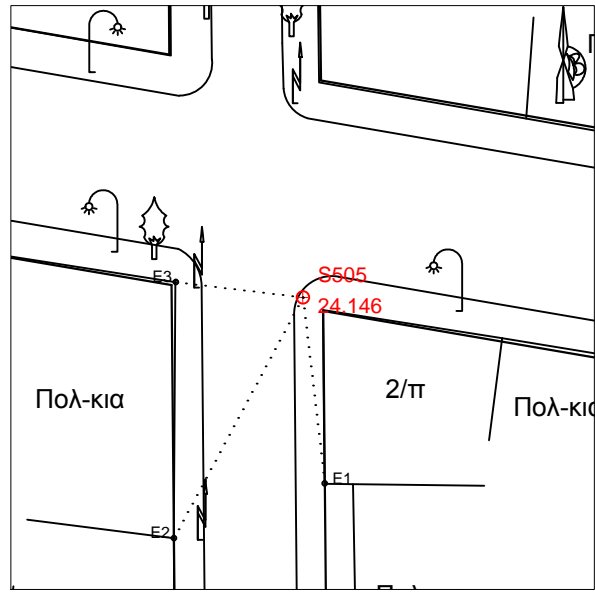

E1= 9.91
 E2= 14.44
 E3= 6.77

S506
 X= 409655.419
 Y= 4500221.365
 H= 26.477

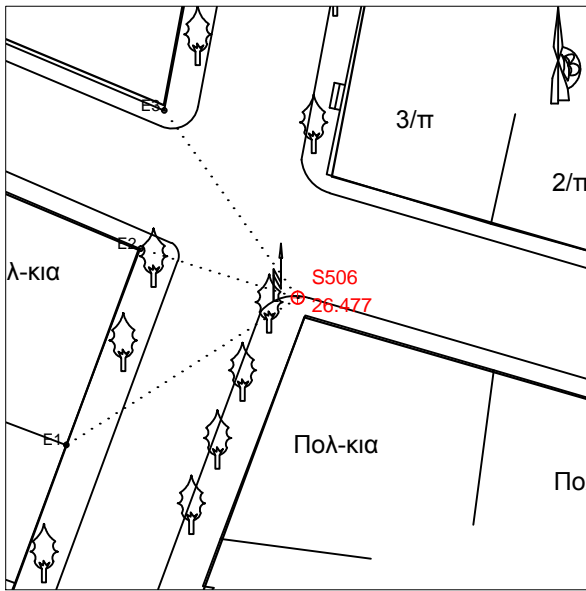

E1= 15.33
 E2= 9.22
 E3= 12.88

S509
 X= 409653.421
 Y= 4500042.146
 H= 18.110

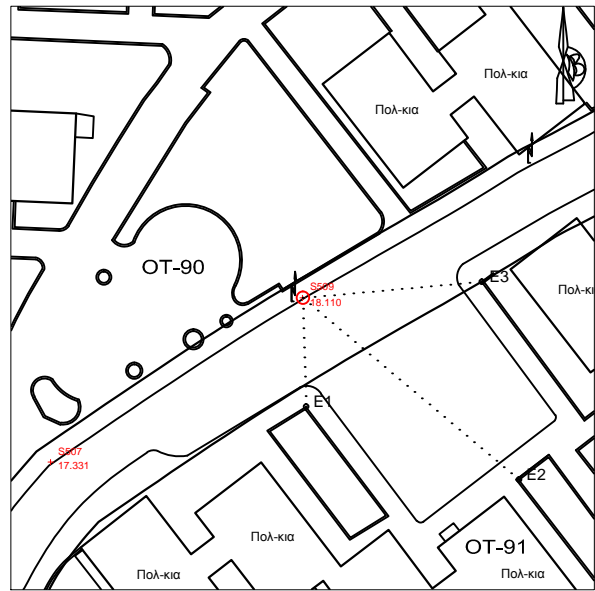

E1= 11.71
 E2= 30.38
 E3= 19.34

S508
 X= 409717.357
 Y= 4499977.925
 H= 20.618

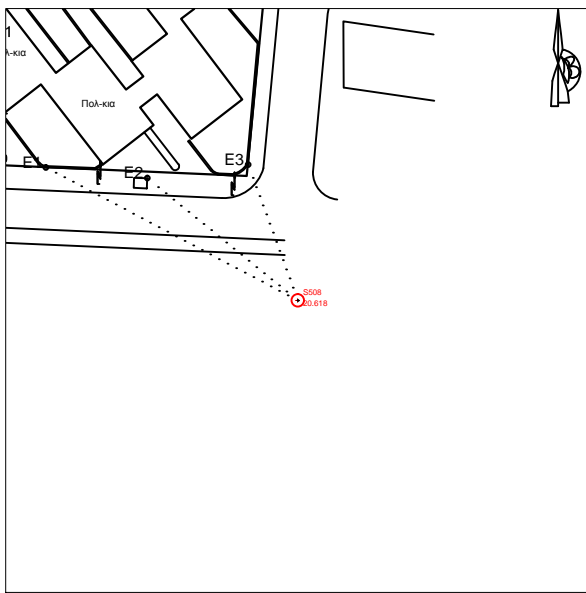

E1= 39.71
 E2= 27.03
 E3= 20.14

S507
 X= 409626.336
 Y= 4500024.511
 H= 17.331

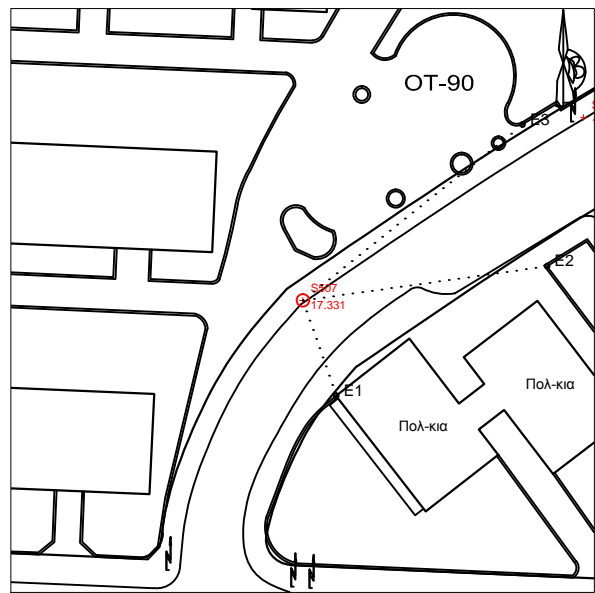

E1= 9.74
 E2= 23.8
 E3= 27.15

S510
X= 409697.674
Y= 4500060.36
H= 19.341

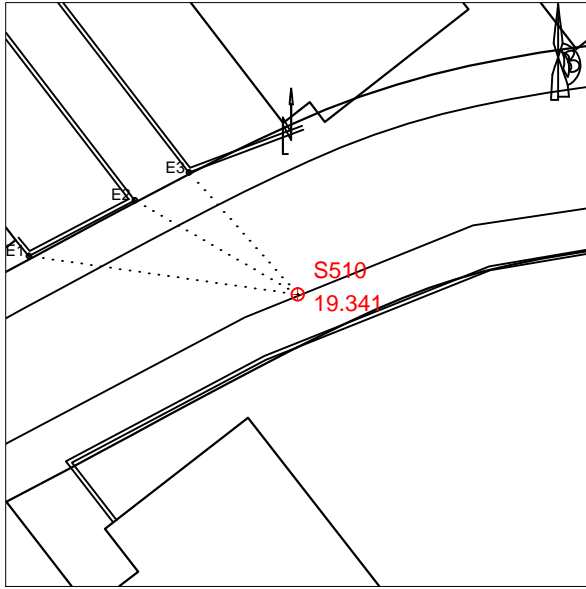

E1= 13.36
E2= 9.25
E3= 8.03

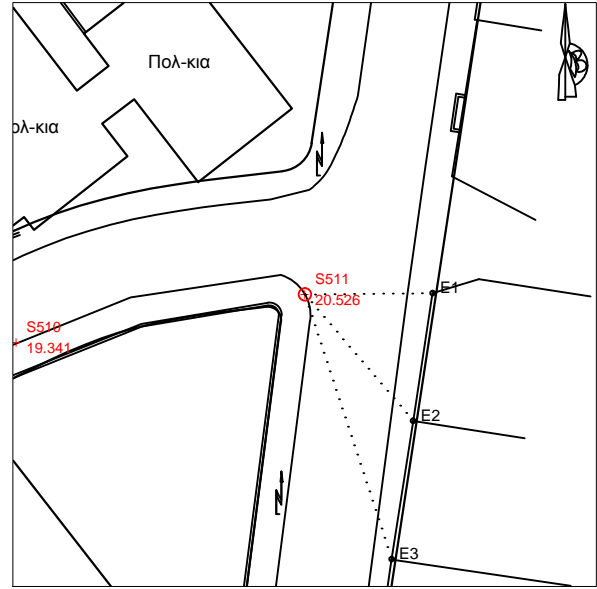

S511
X= 409719.431
Y= 4500063.978
H= 20.526

E1= 9.64
E2= 12.55
E3= 21

S512
X= 409722.783
Y= 4500027.5
H= 20.614

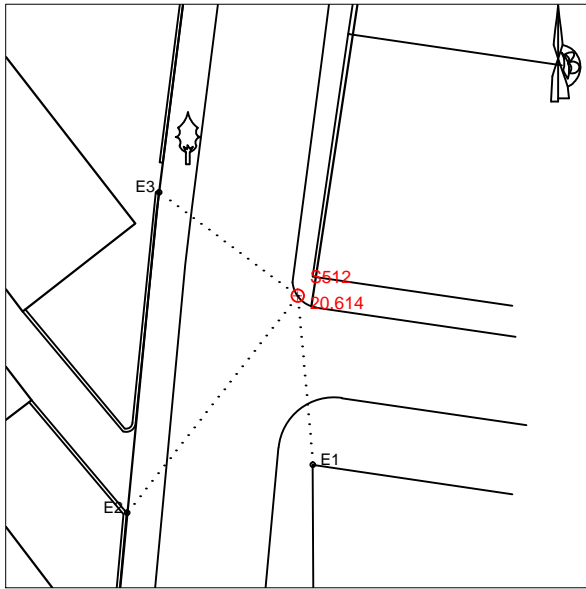

E1= 10.71
E2= 17.42
E3= 10.91

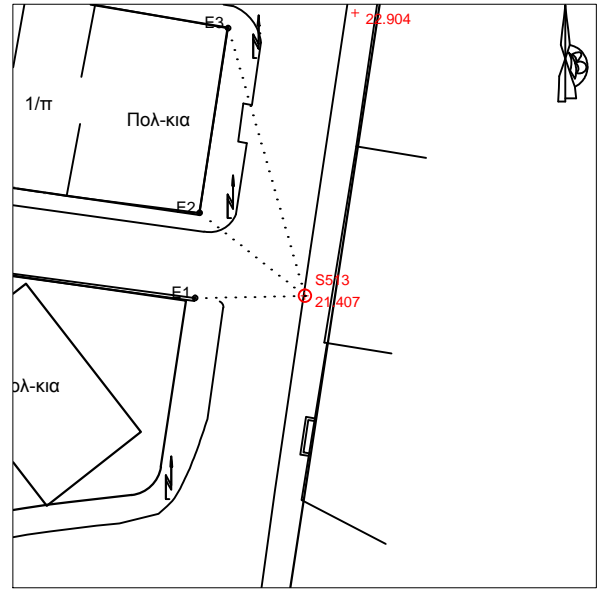

S513
X= 409730.755
Y= 4500088.19
H= 21.407

E1= 8.24
E2= 10.06
E3= 20.9

S514
X= 409675.609
Y= 4500101.103
H= 20.482

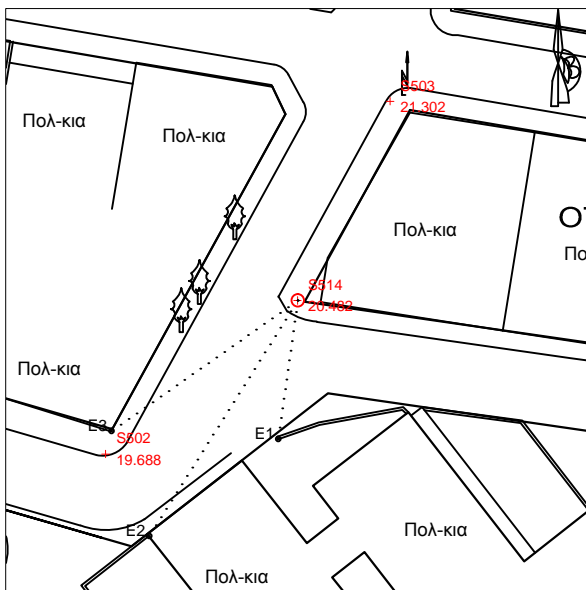

E1= 10.45
E2= 20.77
E3= 16.98

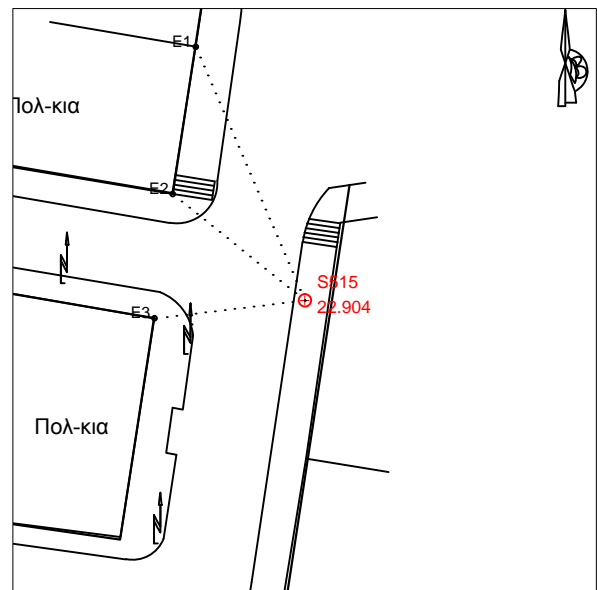

S515
X= 409734.546
Y= 4500109.427
H= 22.904

E1= 17.52
E2= 10.77
E3= 9.61

S516
 X= 409727.983
 Y= 4500147.212
 H= 25.594

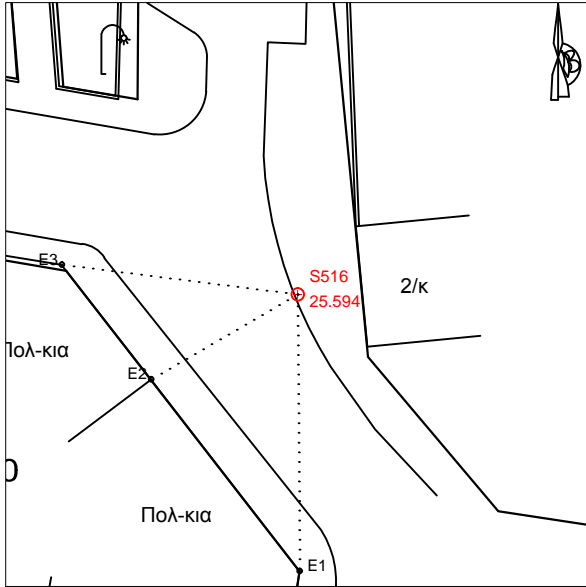

E1= 18.36
 E2= 11.24
 E3= 15.78

S517
 X= 409722.894
 Y= 4500200.768
 H= 27.468

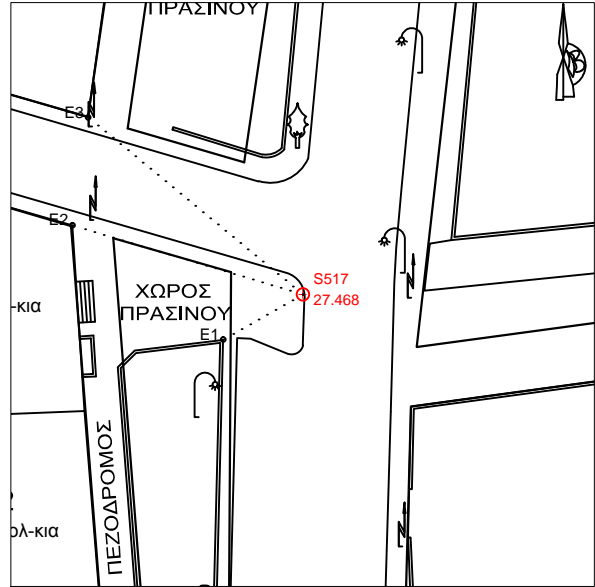

E1= 6.71
 E2= 17.61
 E3= 20.38

S518
 X= 409680.589
 Y= 4500220.82
 H= 26.607

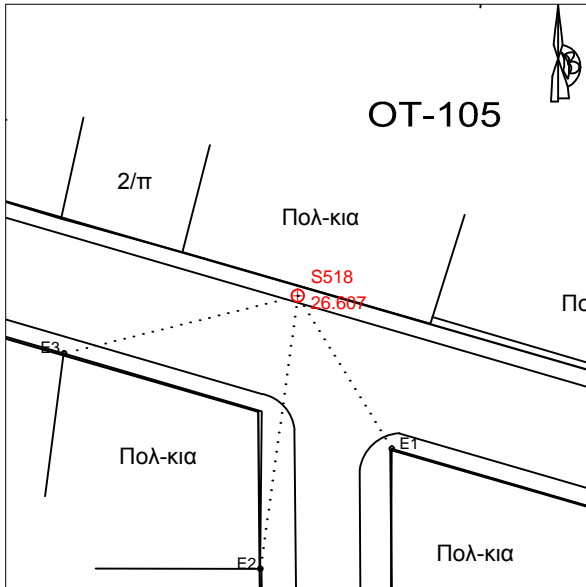

E1= 10.89
 E2= 16.72
 E3= 14.6

S519
 X= 409733.461
 Y= 4500242.979
 H= 29.155

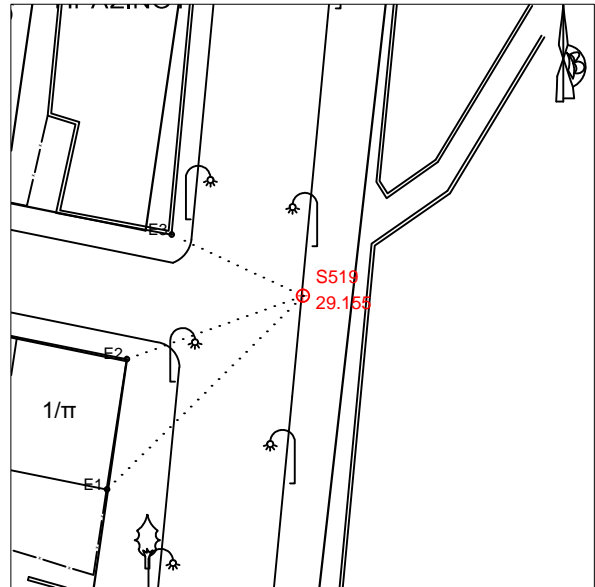

E1= 16.74
 E2= 11.36
 E3= 8.79

S520
 X= 409661.512
 Y= 4500251.757
 H= 28.964

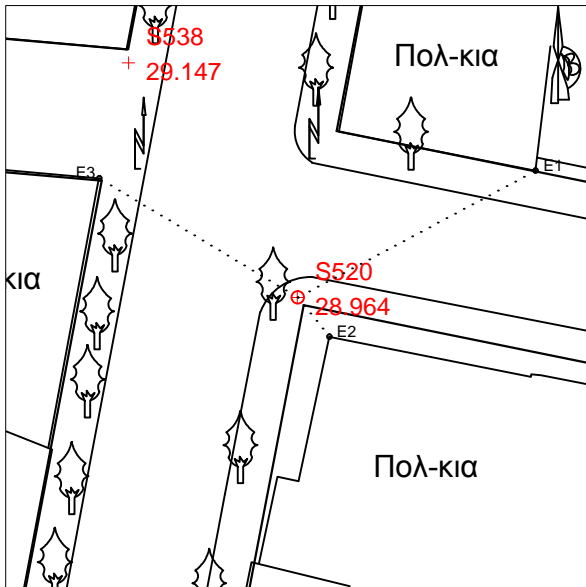

E1= 12.18
 E2= 2.28
 E3= 10.45

S521
 X= 409736.842
 Y= 4500277.903
 H= 30.499

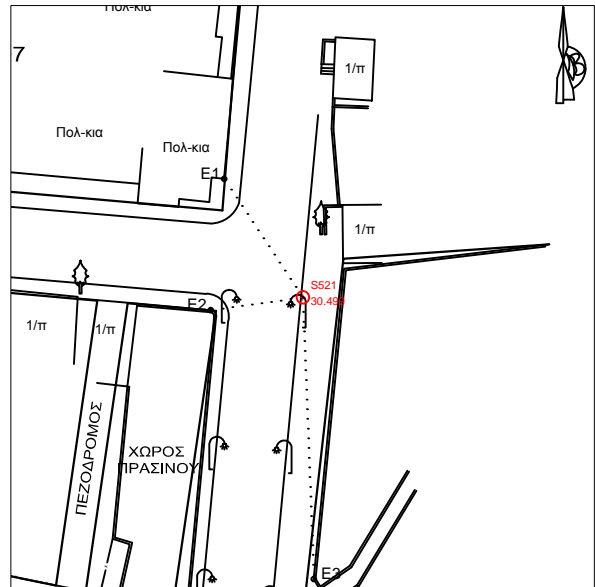

E1= 14.13
 E2= 9.25
 E3= 28

S522
X= 409690.579
Y= 4500280.581
H= 30.164

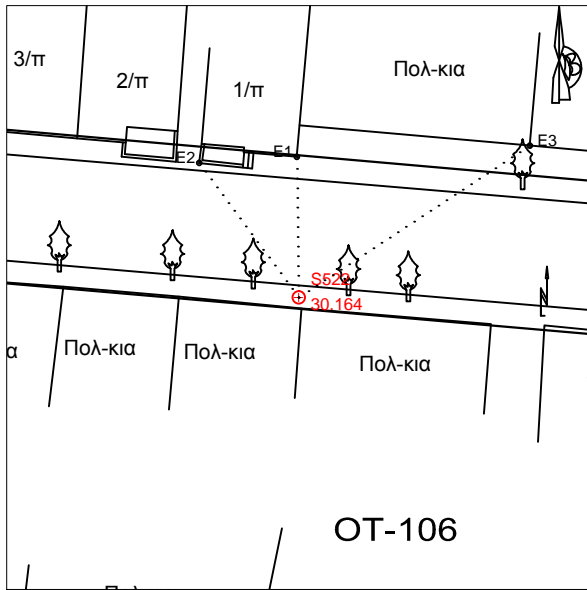

E1= 9.2
E2= 10.94
E3= 18.1

S523
X= 409732.811
Y= 4500319.973
H= 31.157

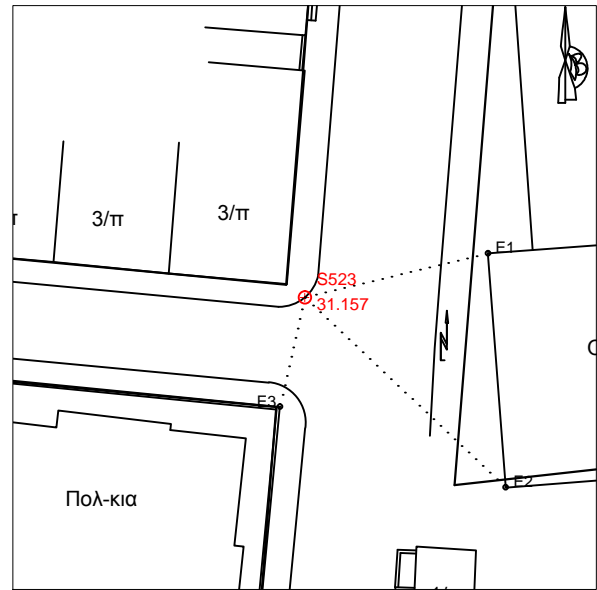

E1= 12.3
E2= 18.05
E3= 7.32

S524
X= 409734.857
Y= 4500348.451
H= 31.345

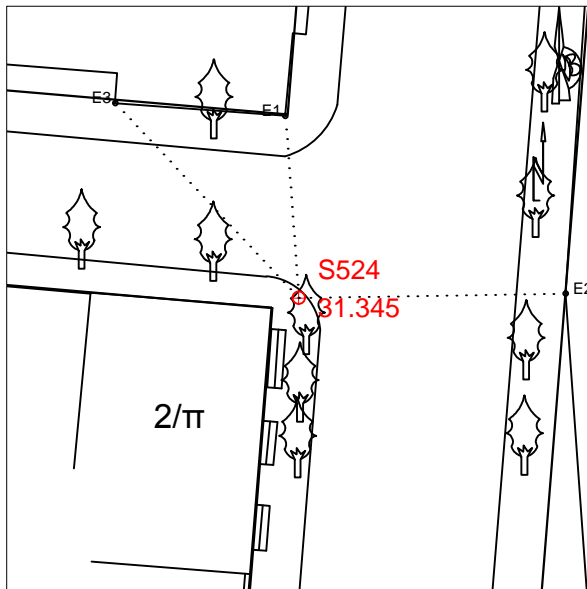

E1= 7.53
E2= 11.01
E3= 11.03

S525
X= 409669.598
Y= 4500319.254
H= 29.730

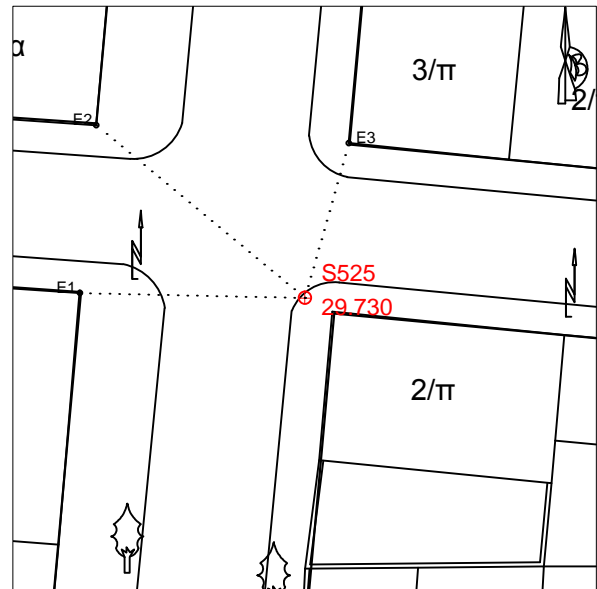

E1= 10.63
E2= 12.78
E3= 7.6

S526
X= 409666.195
Y= 4500361.501
H= 29.827

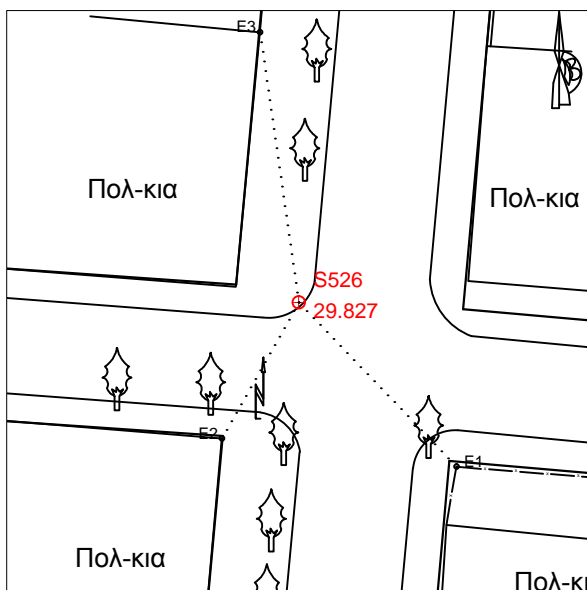

E1= 11.98
E2= 8.21
E3= 14.36

S527
X= 409746.69
Y= 4500387.705
H= 31.535

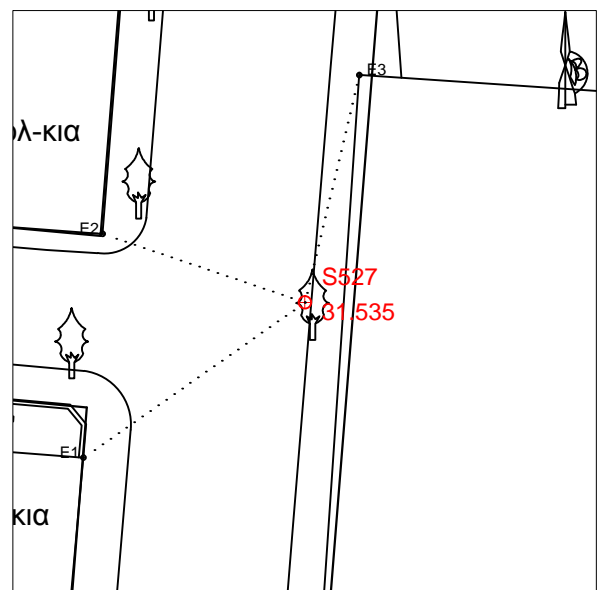

E1= 12.58
E2= 9.93
E3= 10.88

S528
X= 409675.996
Y= 4500389.265
H= 29.761

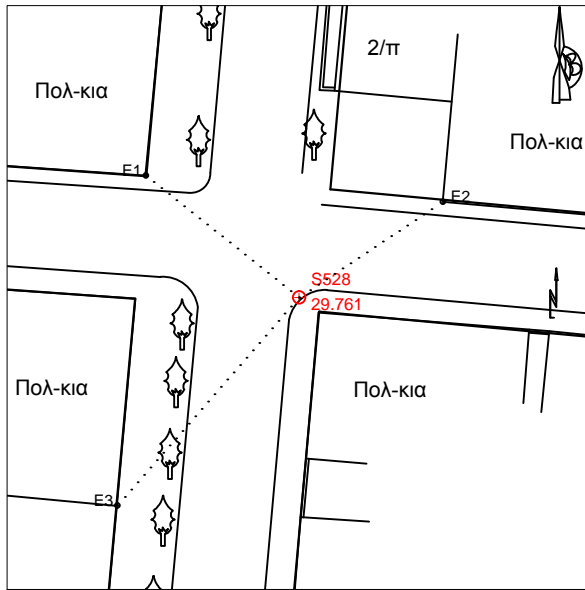

E1= 12.75
E2= 11.24
E3= 17.99

S529
X= 409750.759
Y= 4500418.267
H= 32.562

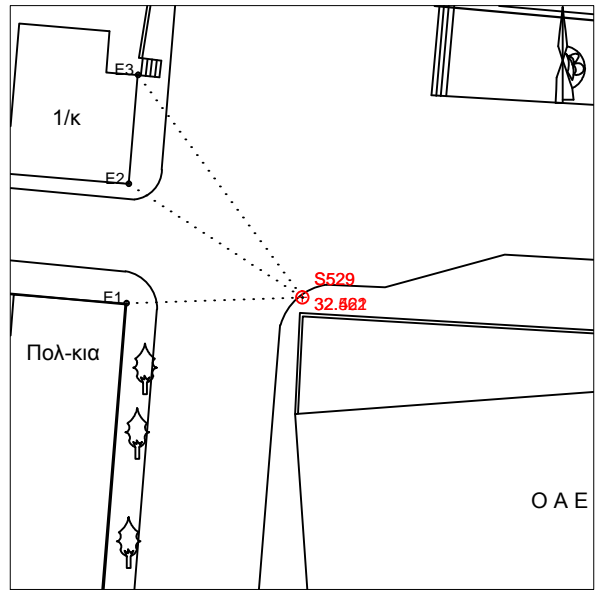

E1= 11.34
E2= 13.38
E3= 17.85

S530
X= 409796.182
Y= 4500429.366
H= 38.236

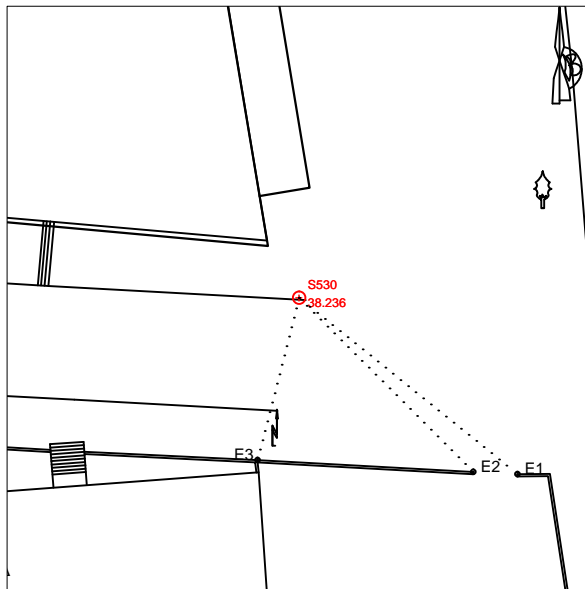

E1= 24.9
E2= 21.85
E3= 14.85

S531
X= 409699.531
Y= 4500422.45
H= 30.574

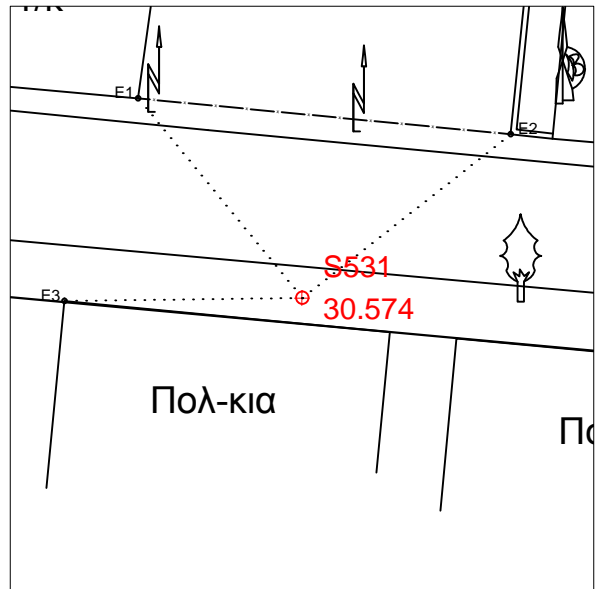

E1= 9.68
E2= 9.93
E3= 8.9

S532
X= 409669.144
Y= 4500424.524
H= 29.841

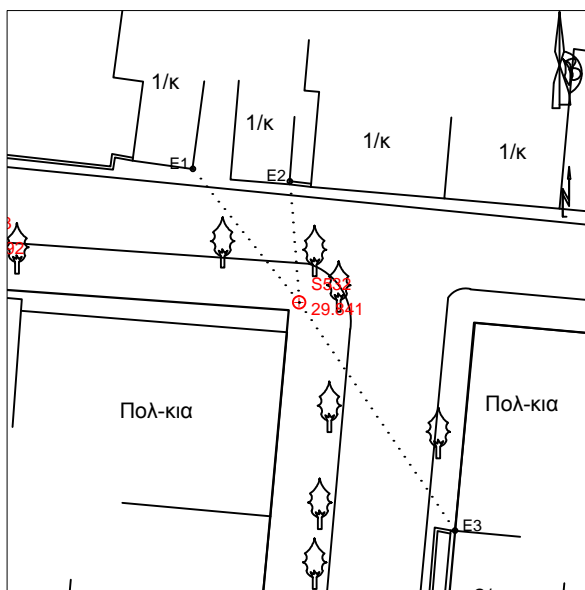

E1= 11.04
E2= 7.86
E3= 17.88

S533
X= 409647.172
Y= 4500428.476
H= 28.792

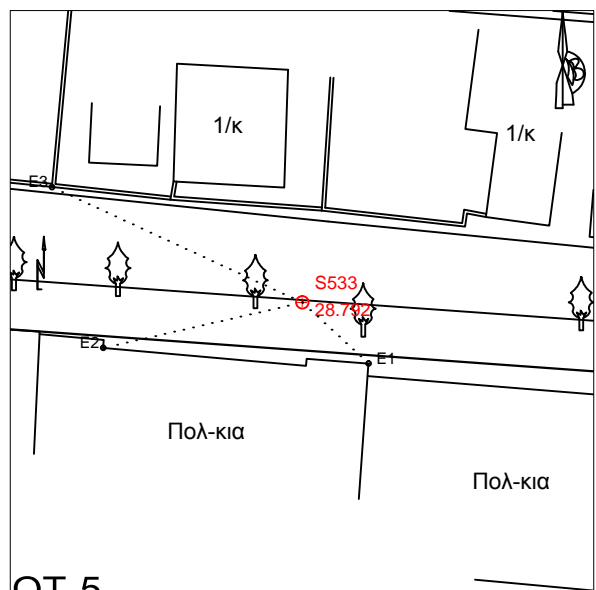

E1= 5.52
E2= 12.46
E3= 16.82

S534
 X= 409640.123
 Y= 4500398.833
 H= 28.360

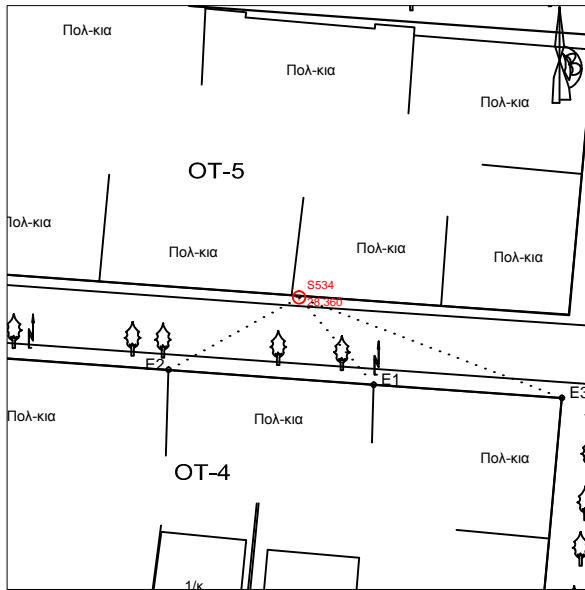

E1= 11.03
 E2= 14.32
 E3= 27.01

S535
 X= 409634.201
 Y= 4500363.774
 H= 28.549

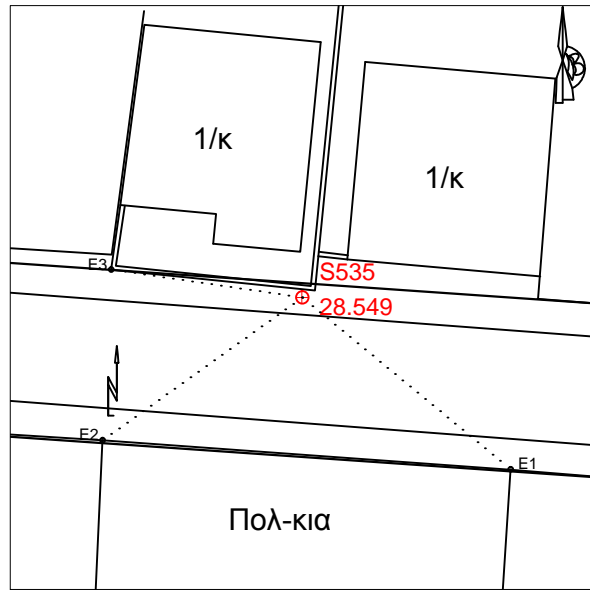

E1= 12.47
 E2= 11.33
 E3= 8.91

S536
 X= 409659.523
 Y= 4500291.522
 H= 29.836

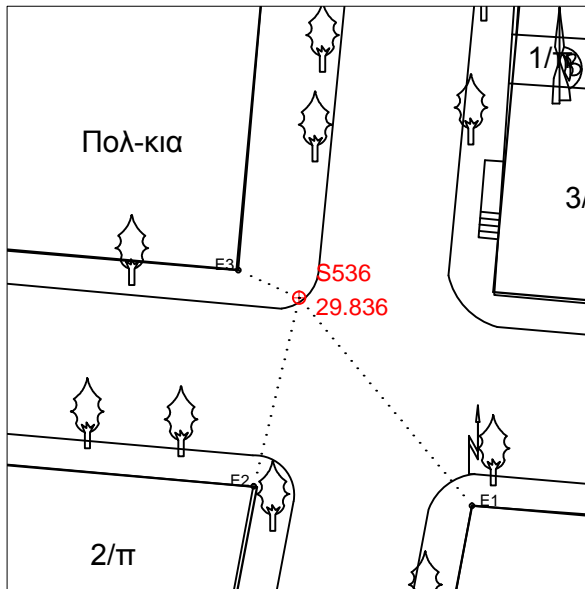

E1= 12.6
 E2= 9.04
 E3= 3.11

S537
 X= 409628.271
 Y= 4500329.25
 H= 28.450

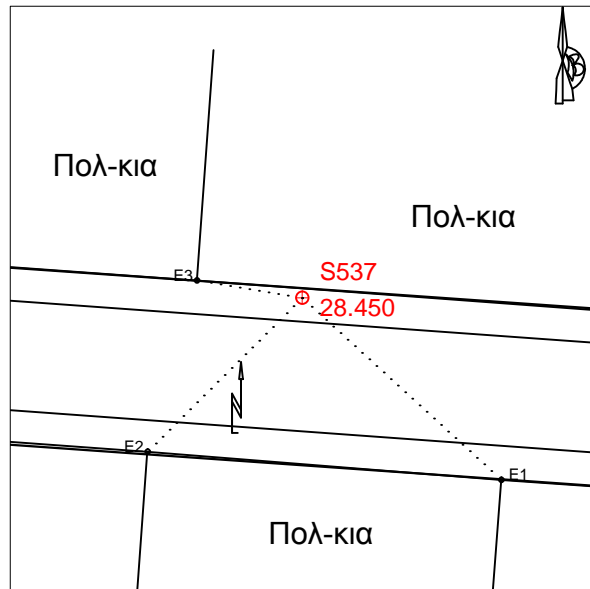

E1= 12.21
 E2= 9.87
 E3= 4.83

S538
 X= 409653.889
 Y= 4500262.343
 H= 29.147

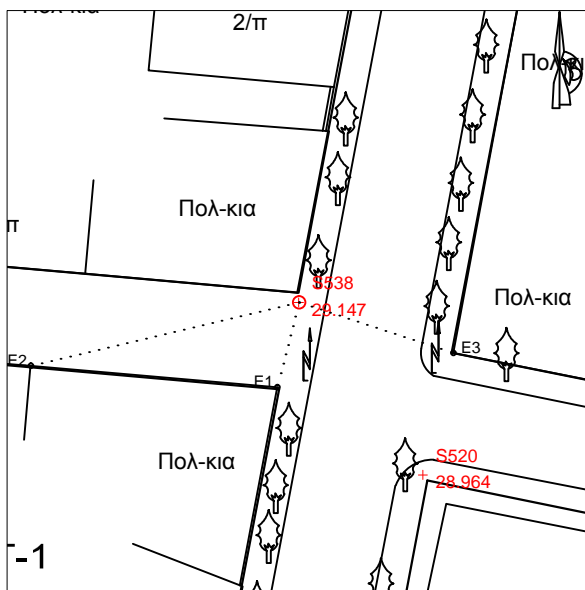

E1= 5.38
 E2= 16.93
 E3= 9.99

S539
 X= 409628.846
 Y= 4500294.393
 H= 29.166

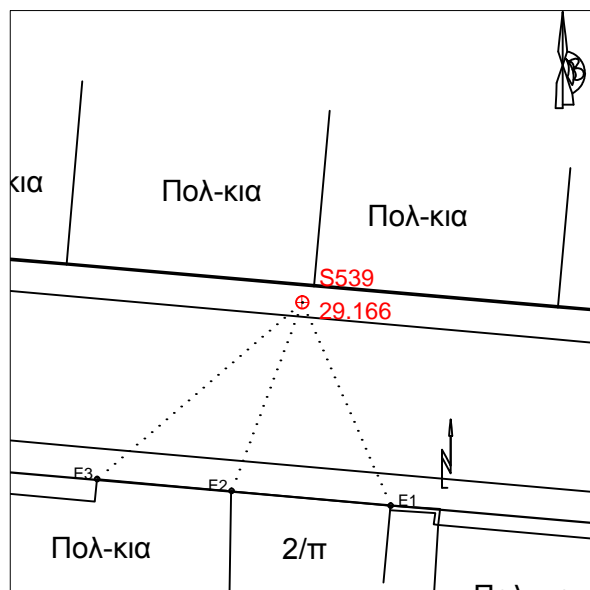

E1= 10.41
 E2= 9.47
 E3= 12.71

S540
 X= 409612.293
 Y= 4500246.283
 H= 25.931

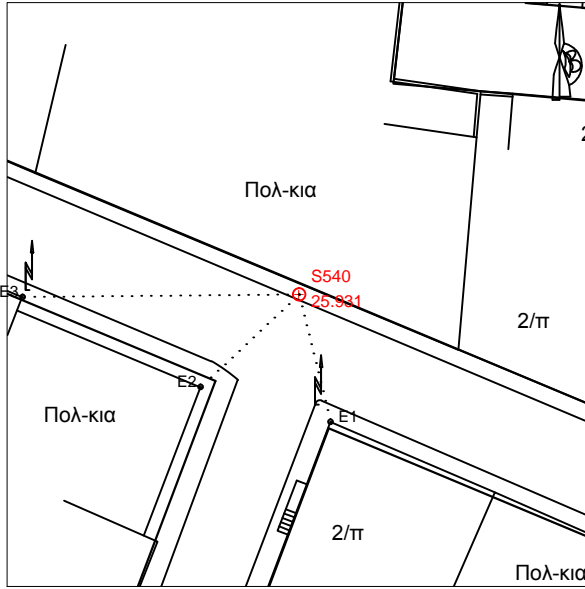

E1= 8.57
 E2= 8.82
 E3= 18.04

S541
 X= 409599.287
 Y= 4500199.136
 H= 23.766

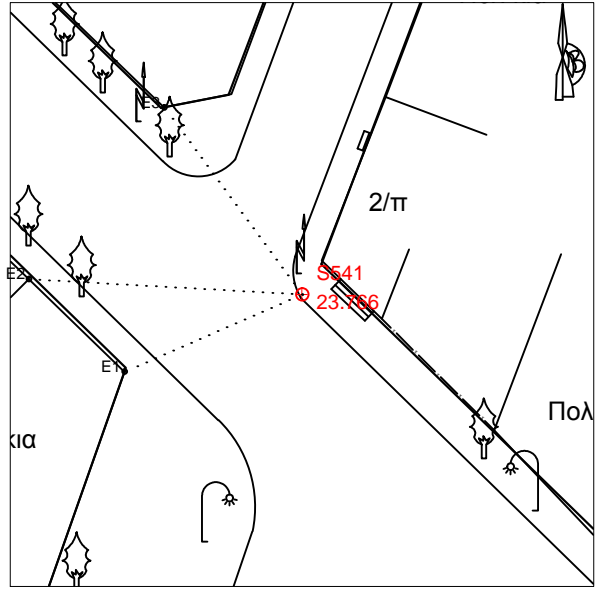

E1= 10.57
 E2= 14.93
 E3= 12.68

S542
 X= 409583.532
 Y= 4500258.552
 H= 25.394

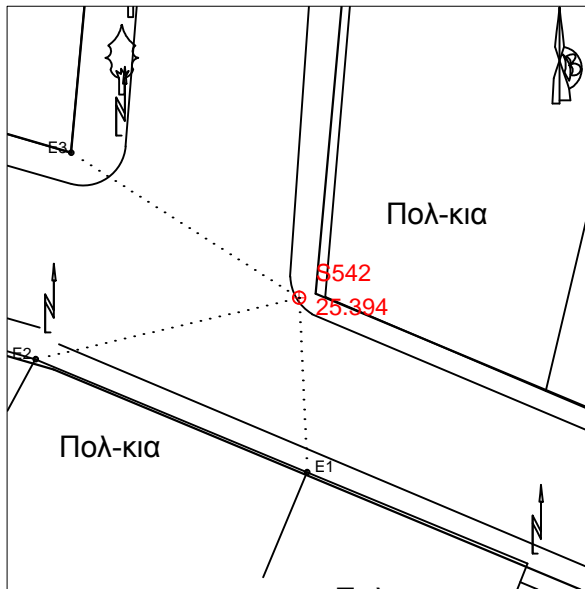

E1= 8.18
 E2= 12.68
 E3= 12.66

S542A
 X= 409553.534
 Y= 4500261.94
 H= 23.836

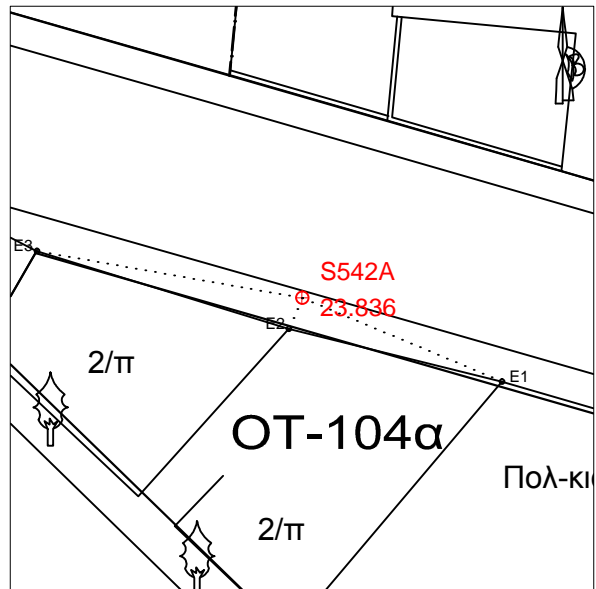

E1= 9.67
 E2= 1.51
 E3= 12.03

S543
 X= 409546.823
 Y= 4500238.844
 H= 22.728

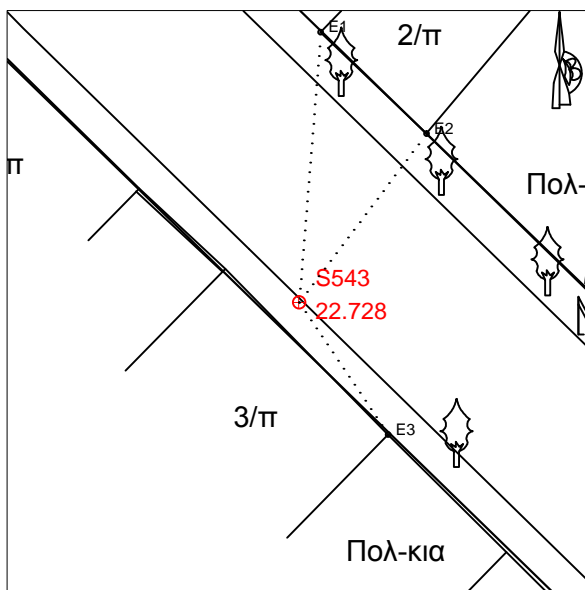

E1= 12.96
 E2= 10.12
 E3= 7.63

S544
 X= 409577.93
 Y= 4500298.889
 H= 26.566

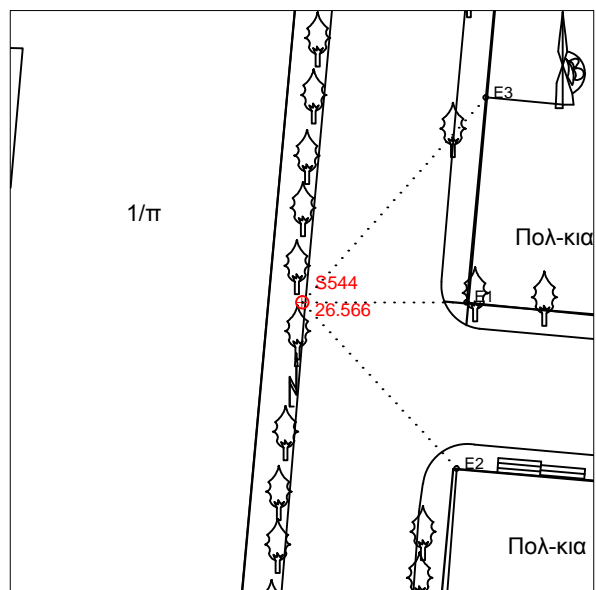

E1= 9.92
 E2= 13.69
 E3= 16.6

S545
 X= 409593.178
 Y= 4500366.481
 H= 27.213

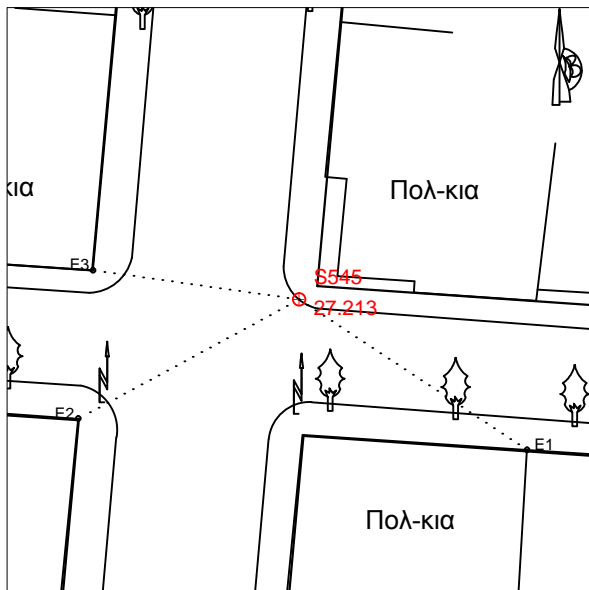

E1= 14.54
 E2= 13.35
 E3= 11.07

S546
 X= 409586.45
 Y= 4500402.436
 H= 26.197

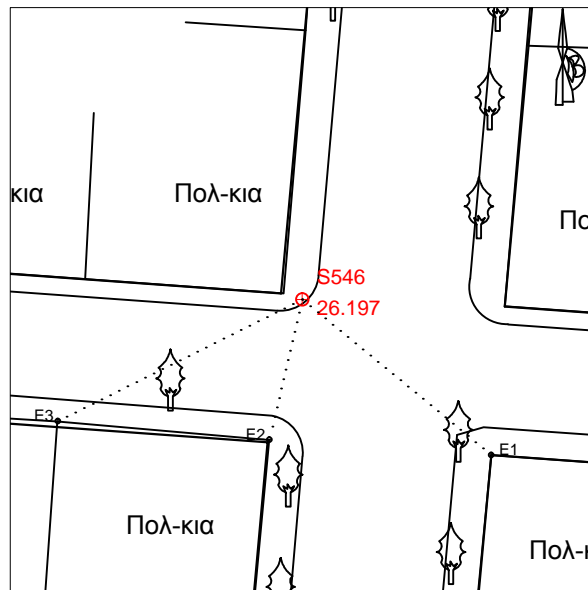

E1= 13.13
 E2= 7.73
 E3= 14.65

S547
 X= 409588.236
 Y= 4500432.504
 H= 26.652

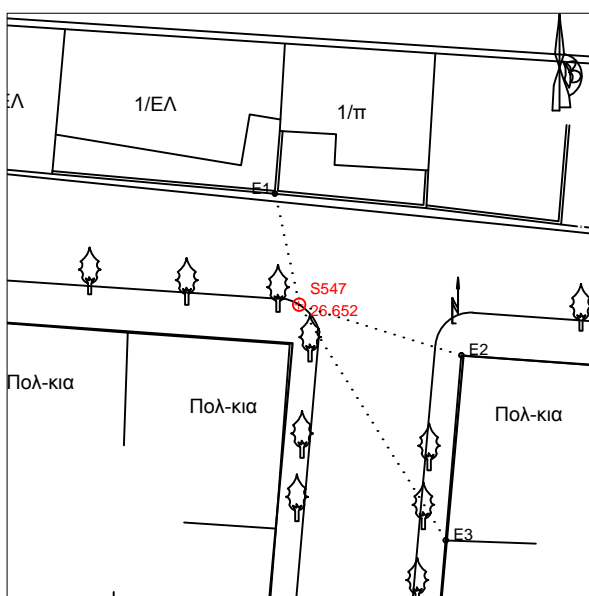

E1= 7.97
 E2= 11.89
 E3= 19.42

S548
 X= 409544.589
 Y= 4500434.555
 H= 25.155

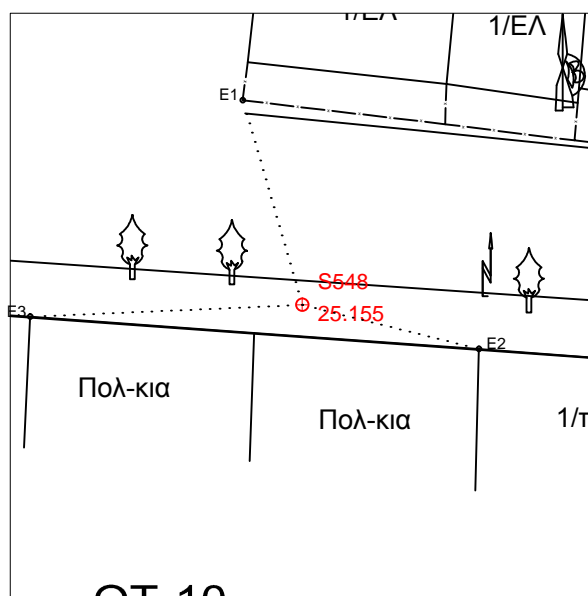

E1= 10.83
 E2= 9.25
 E3= 13.83

S550
 X= 409412.263
 Y= 4500642.859
 H= 25.720

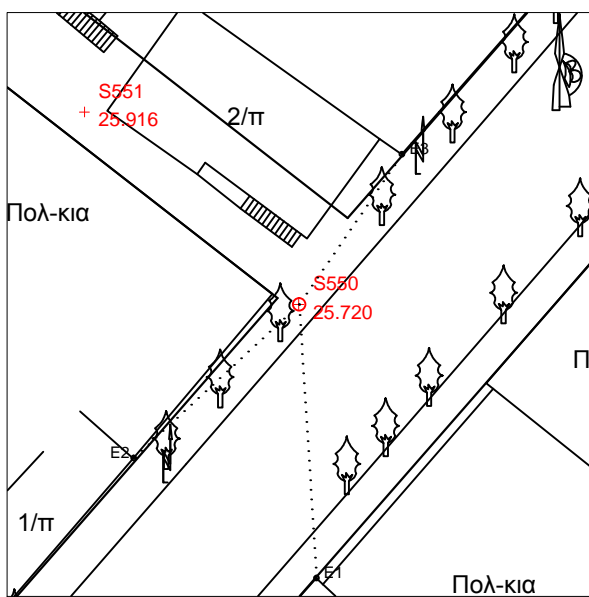

E1= 15.47
 E2= 12.75
 E3= 10.26

S551
 X= 409400.173
 Y= 4500653.714
 H= 25.916

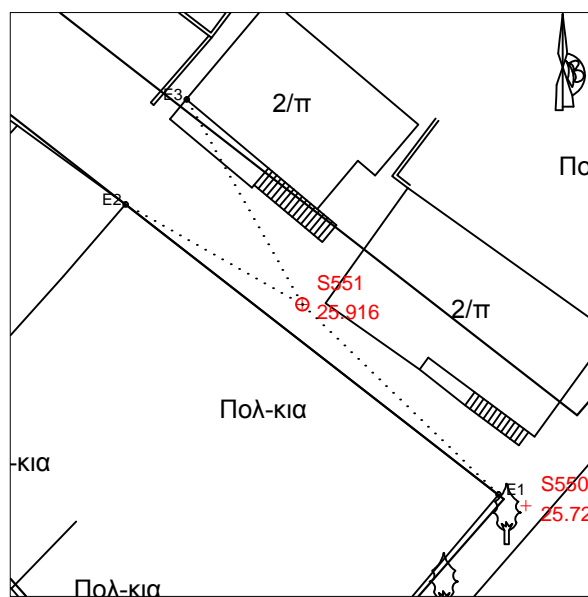

E1= 14.76
 E2= 10.95
 E3= 12.7

S545
 X= 409593.178
 Y= 4500366.481
 H= 27.213

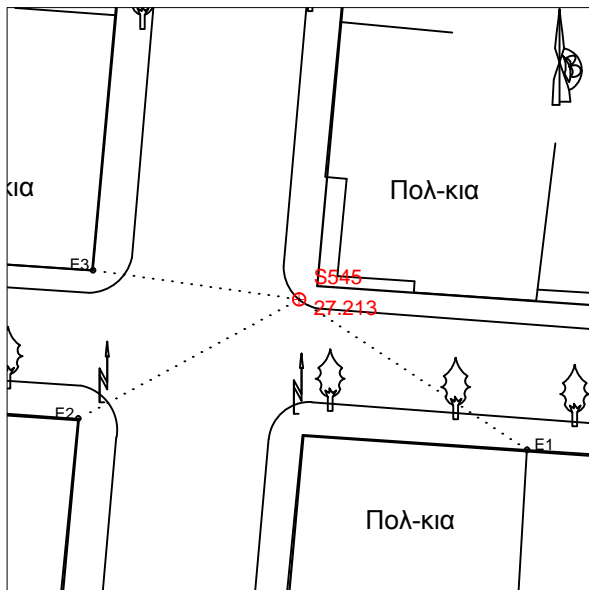

E1= 14.54
 E2= 13.35
 E3= 11.07

S546
 X= 409586.45
 Y= 4500402.436
 H= 26.197

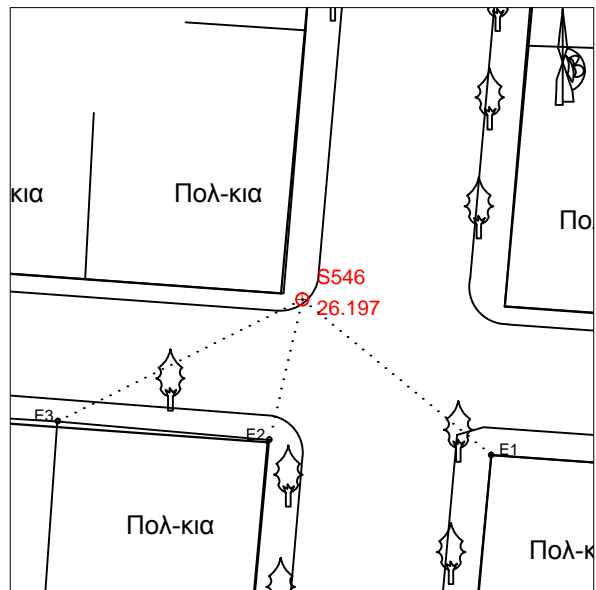

E1= 13.13
 E2= 7.73
 E3= 14.65

S547
 X= 409588.236
 Y= 4500432.504
 H= 26.652

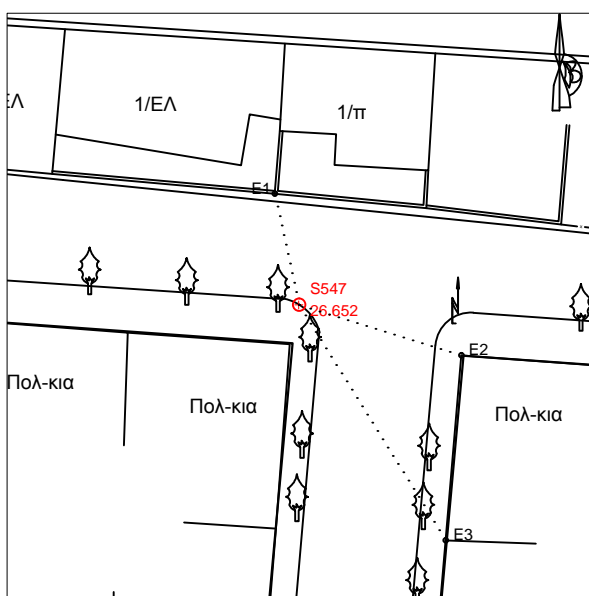

E1= 7.97
 E2= 11.89
 E3= 19.42

S548
 X= 409544.589
 Y= 4500434.555
 H= 25.155

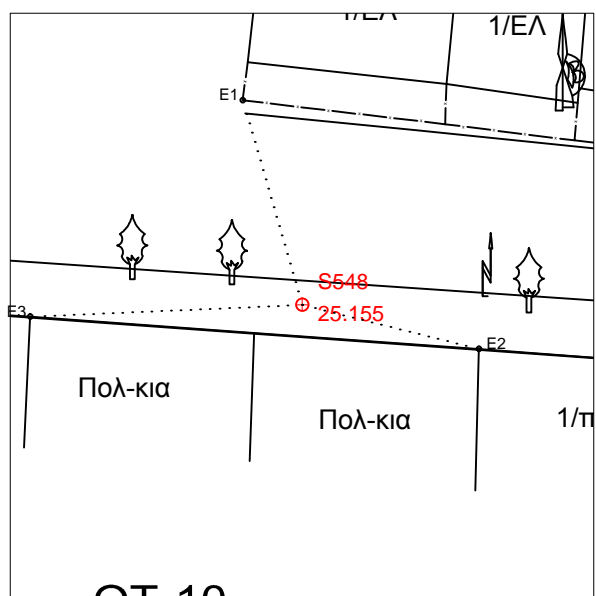

E1= 10.83
 E2= 9.25
 E3= 13.83

S550
 X= 409412.263
 Y= 4500642.859
 H= 25.720

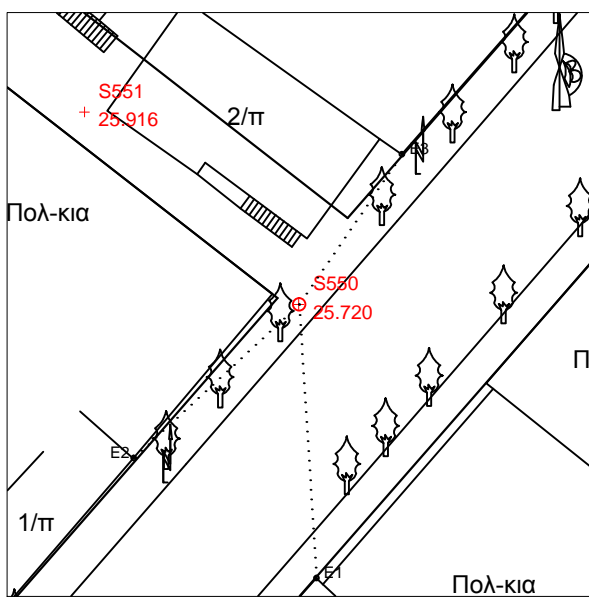

E1= 15.47
 E2= 12.75
 E3= 10.26

S551
 X= 409400.173
 Y= 4500653.714
 H= 25.916

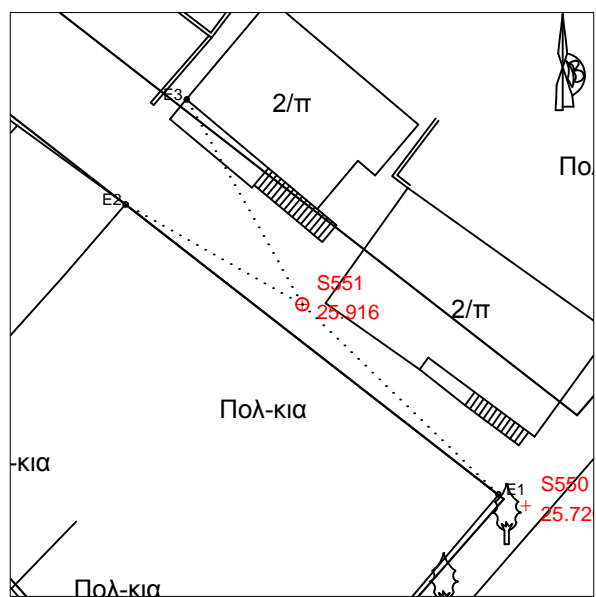

E1= 14.76
 E2= 10.95
 E3= 12.7

S552
X= 409445.617
Y= 4500669.652
H= 27.712

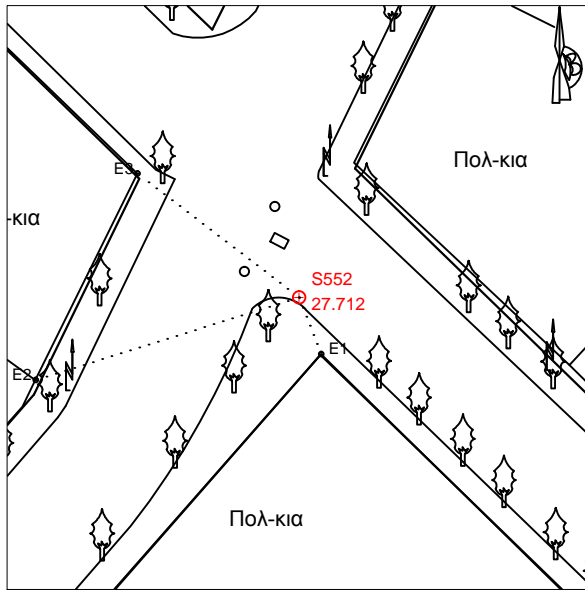

E1= 3.86
E2= 17.5
E3= 12.9

S553
X= 409366.219
Y= 4500682.84
H= 25.720

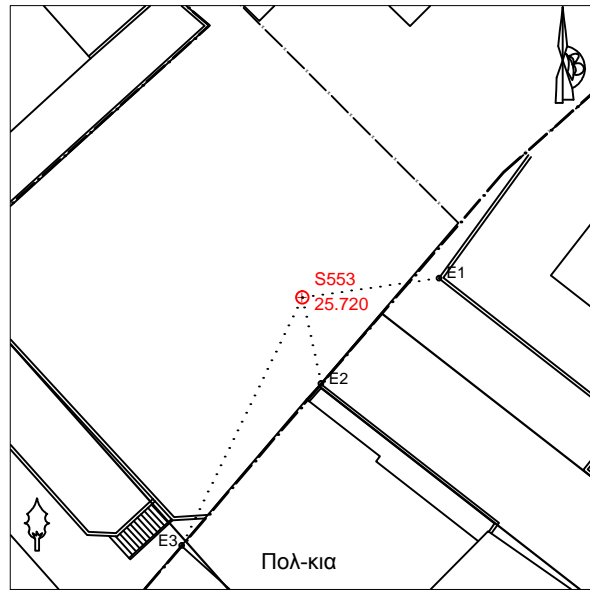

E1= 8.65
E2= 5.53
E3= 17.27

S554
X= 409398.751
Y= 4500725.385
H= 26.944

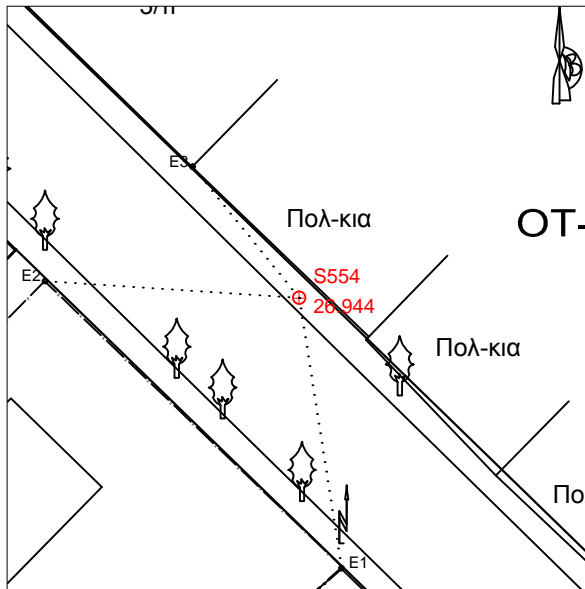

E1= 15.14
E2= 14.08
E3= 9.34

S555
X= 409455.903
Y= 4500716.981
H= 28.532

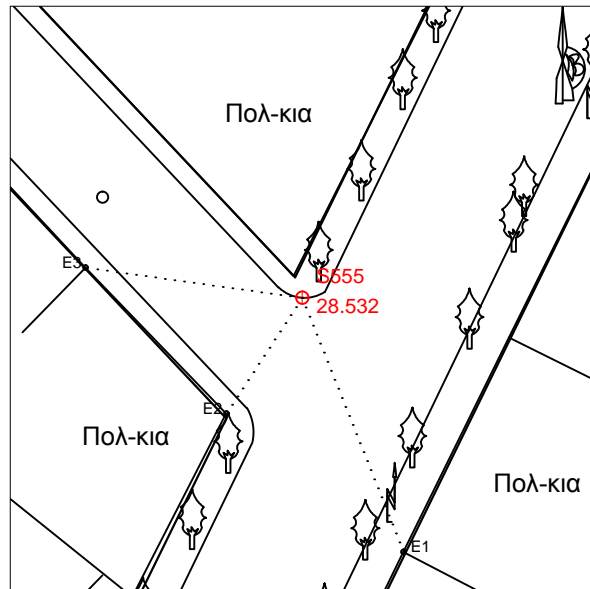

E1= 14.9
E2= 7.53
E3= 11.91

S556
X= 409481.871
Y= 4500632.242
H= 29.860

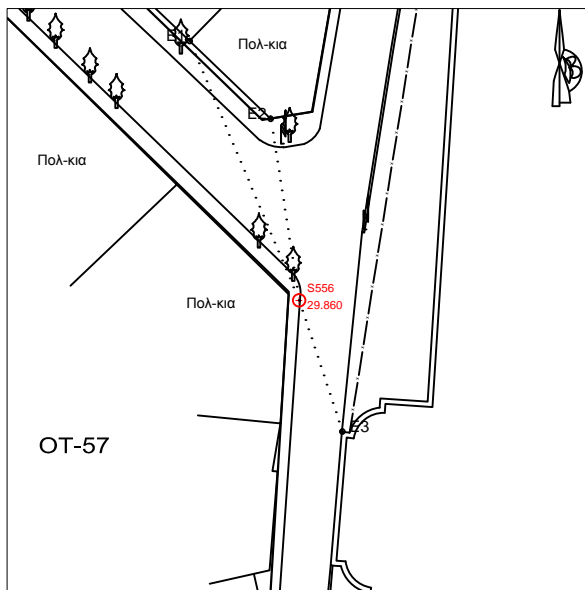

E1= 26.91
E2= 17.58
E3= 13.2

S557
X= 409366.711
Y= 4500745.81
H= 26.470

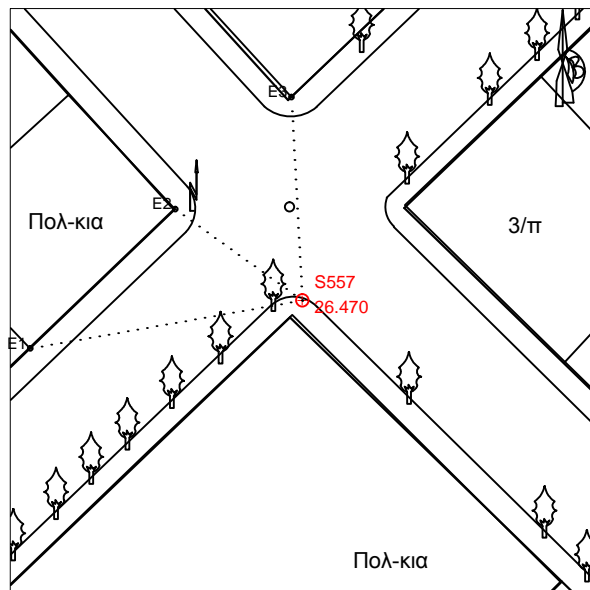

E1= 17.45
E2= 9.87
E3= 12.88

S558
 X= 409313.484
 Y= 4500708.131
 H= 23.860

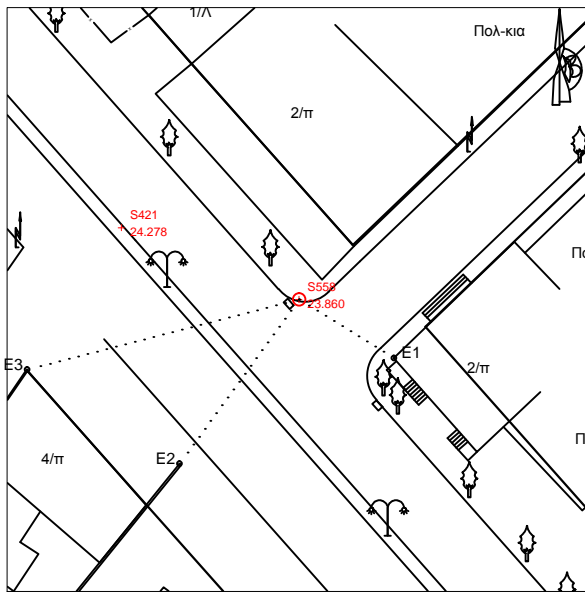

E1= 10.23
 E2= 18.66
 E3= 25.79

S559
 X= 409343.205
 Y= 4500781.603
 H= 26.471

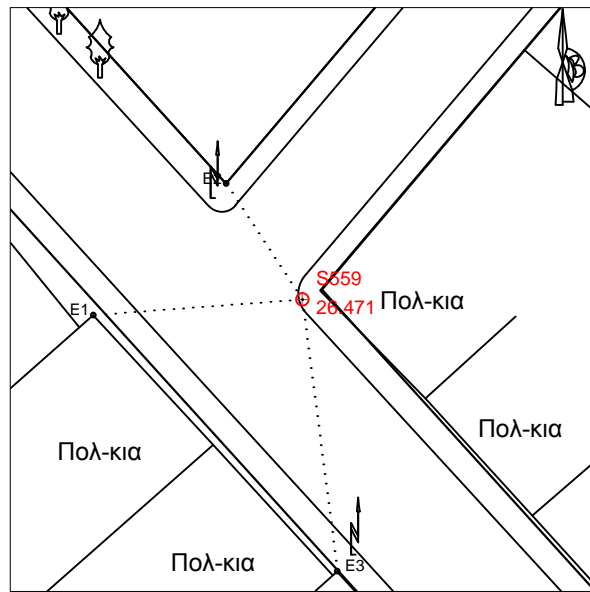

E1= 11.84
 E2= 7.83
 E3= 15.49

S560
 X= 409392.465
 Y= 4500781.98
 H= 27.576

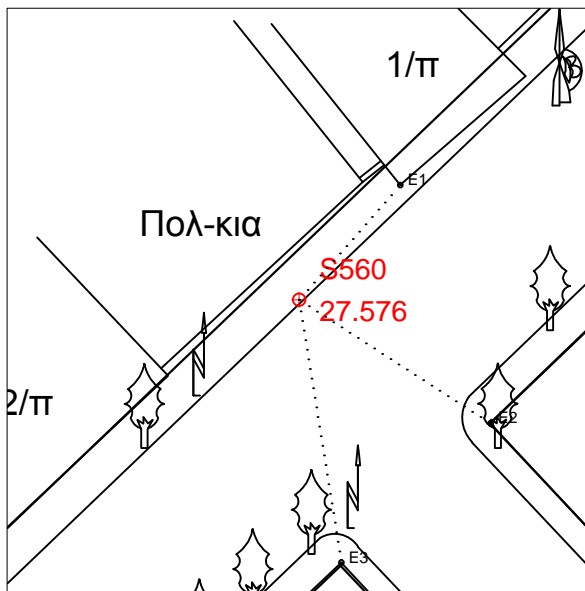

E1= 5.94
 E2= 8.84
 E3= 10.32

S561
 X= 409297.914
 Y= 4500819.698
 H= 25.445

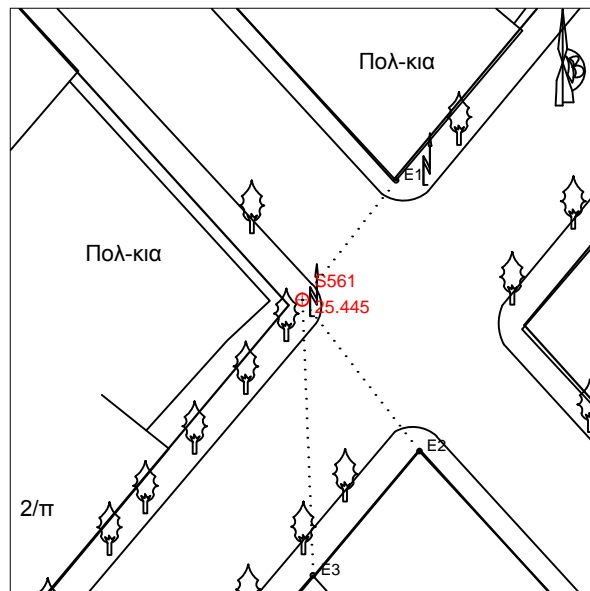

E1= 9.44
 E2= 11.87
 E3= 17.11

S562
 X= 409383.516
 Y= 4500838.985
 H= 27.635

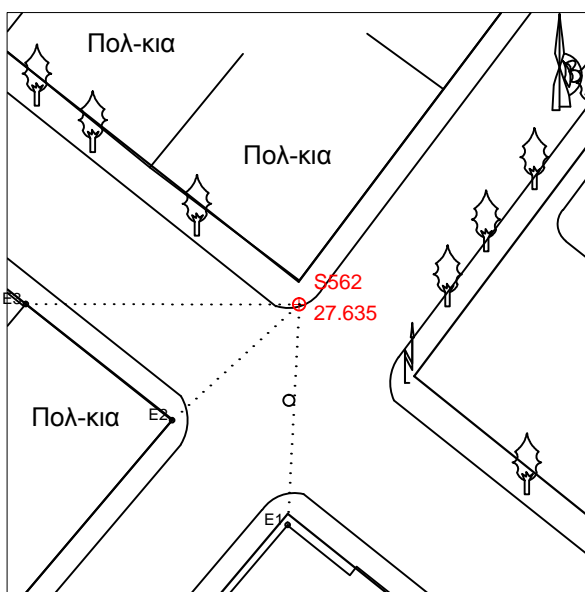

E1= 11.86
 E2= 9.23
 E3= 14.67

S563
 X= 409285.548
 Y= 4500846.529
 H= 25.334

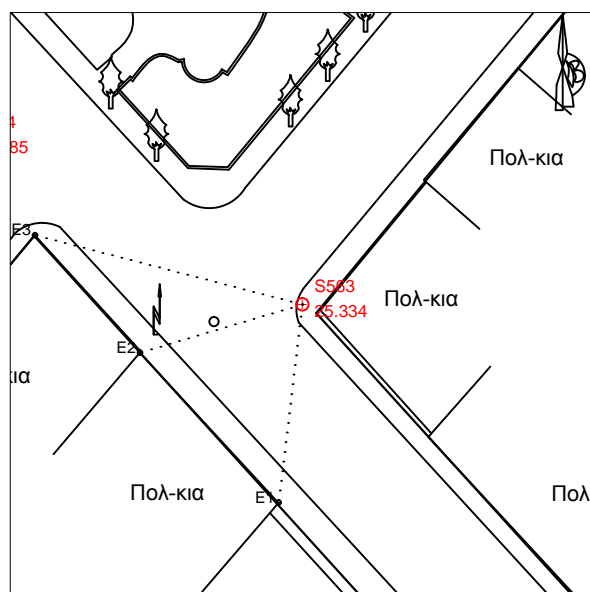

E1= 12.71
 E2= 10.77
 E3= 17.58

S564
 X= 409263.984
 Y= 4500856.962
 H= 25.185

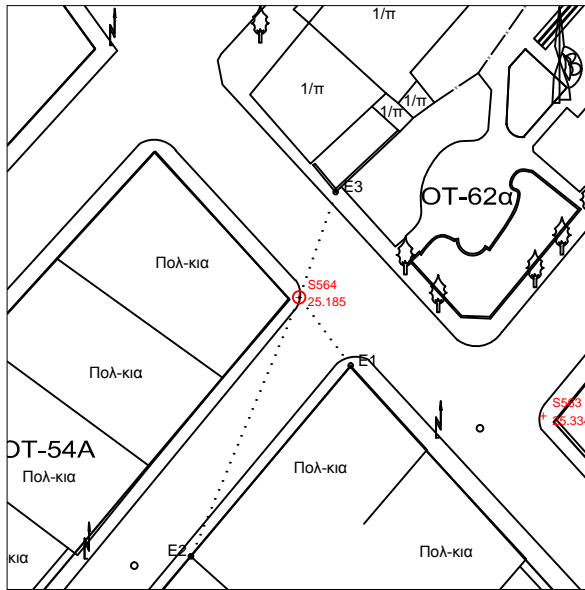

E1= 7.55
 E2= 24.75
 E3= 9.84

S565
 X= 409308.291
 Y= 4500885.984
 H= 26.290

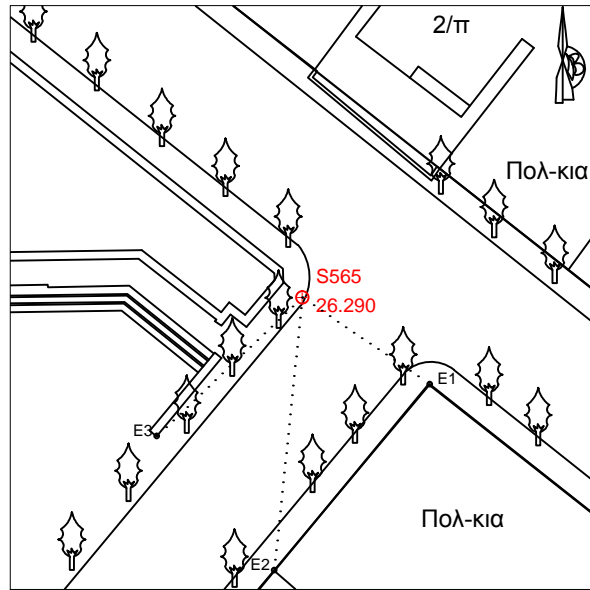

E1= 8.76
 E2= 15.56
 E3= 11.4

S566
 X= 409252.644
 Y= 4500885.608
 H= 25.214

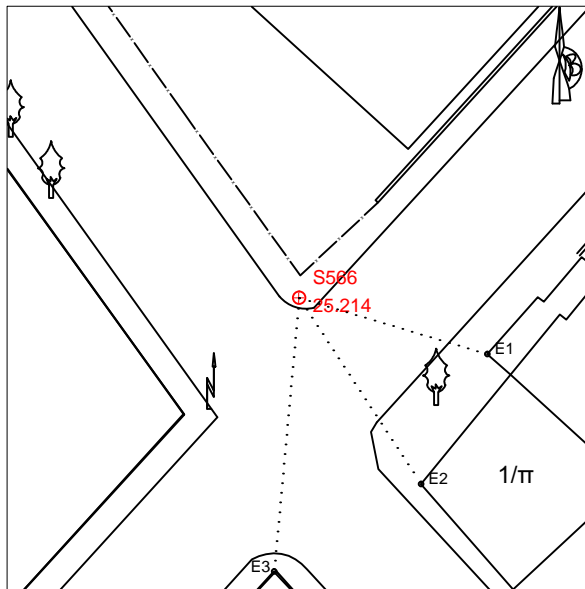

E1= 11.36
 E2= 12.85
 E3= 15.86

S567
 X= 409224.355
 Y= 4500842.782
 H= 24.412

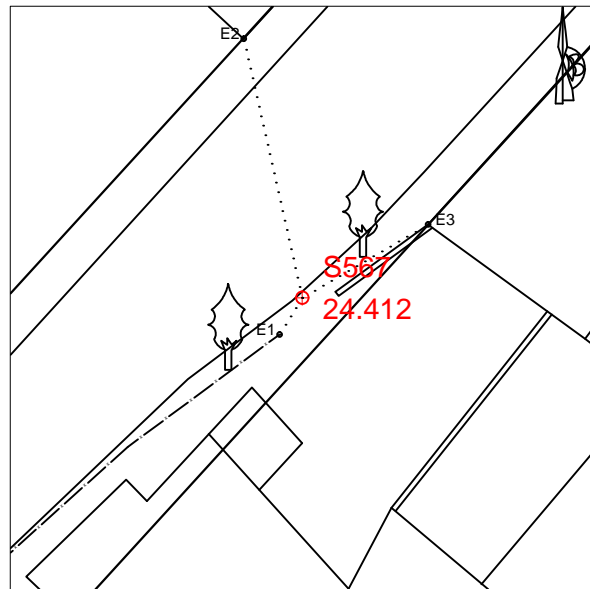

E1= 1.64
 E2= 10.12
 E3= 5.56

S568
 X= 409217.798
 Y= 4500918.89
 H= 24.699

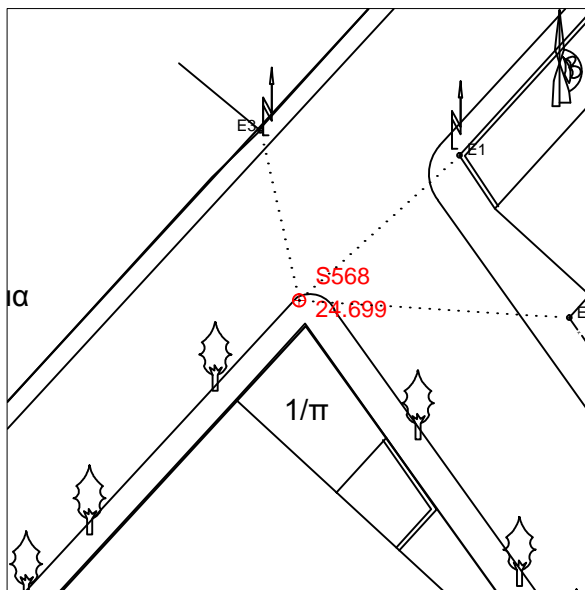

E1= 10.26
 E2= 12.84
 E3= 8.26

S569
 X= 409289.929
 Y= 4500913.409
 H= 25.953

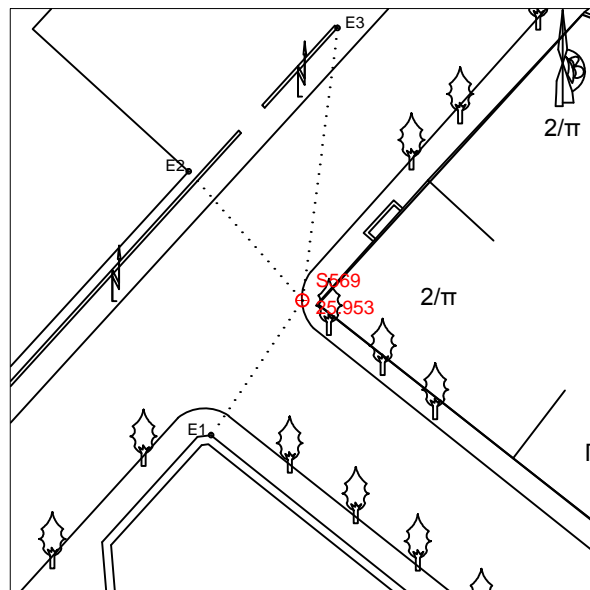

E1= 9.45
 E2= 9.98
 E3= 15.95

S570
 X= 409302.472
 Y= 4500960.139
 H= 25.754

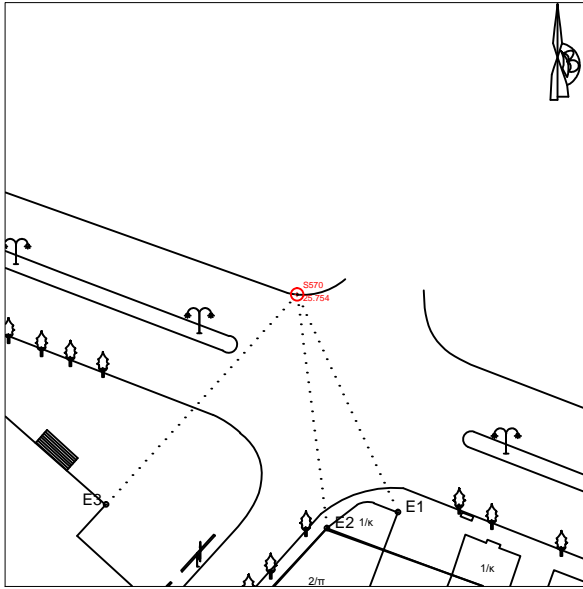

E1= 30.81
 E2= 30.23
 E3= 36.46

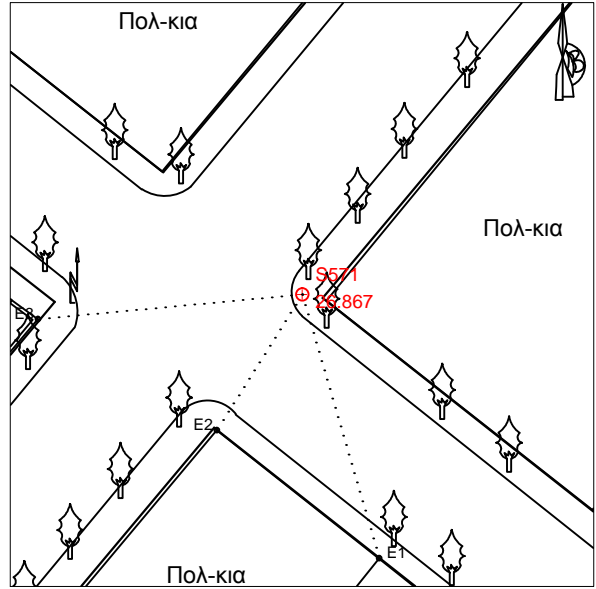

S571
 X= 409350.157
 Y= 4500865.716
 H= 26.867

E1= 16.27
 E2= 9.48
 E3= 15.7

S572
 X= 409385.249
 Y= 4500917.873
 H= 27.725

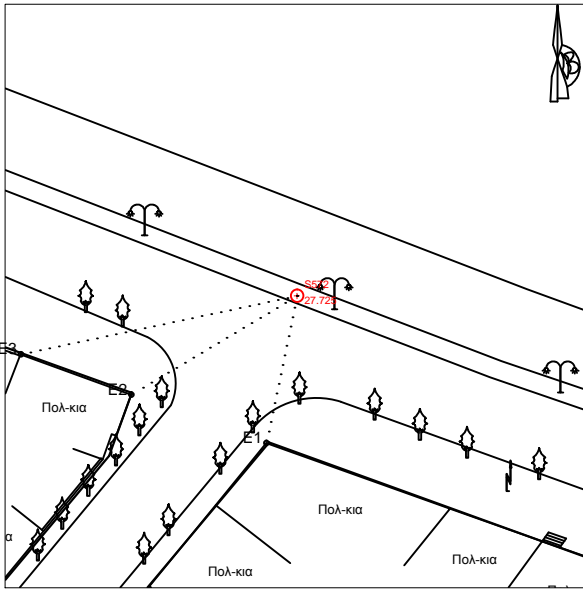

E1= 15.79
 E2= 20.25
 E3= 29.65

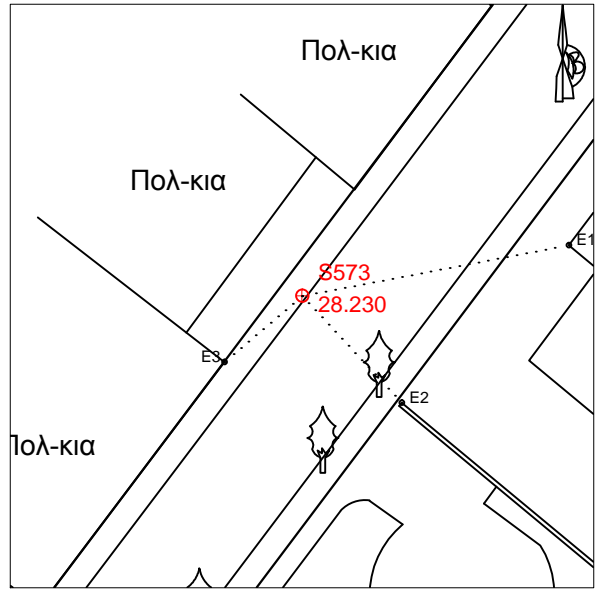

S573
 X= 409404.245
 Y= 4500865.898
 H= 28.230

E1= 13.42
 E2= 7.22
 E3= 5.03

S574
 X= 409431.44
 Y= 4500900.632
 H= 28.750

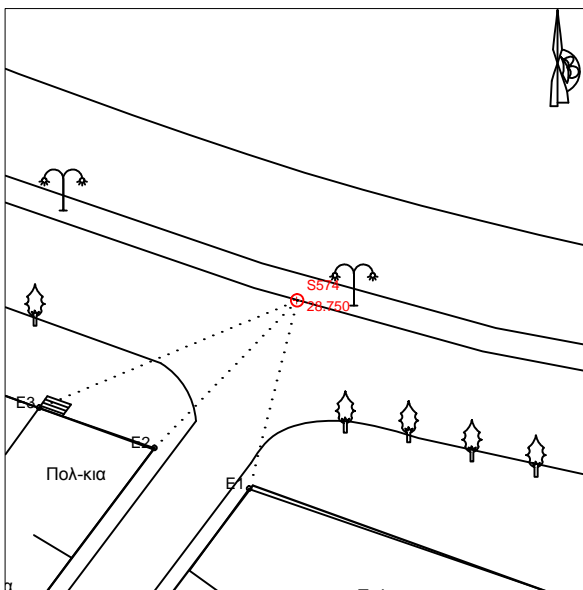

E1= 15.39
 E2= 16.26
 E3= 22.12

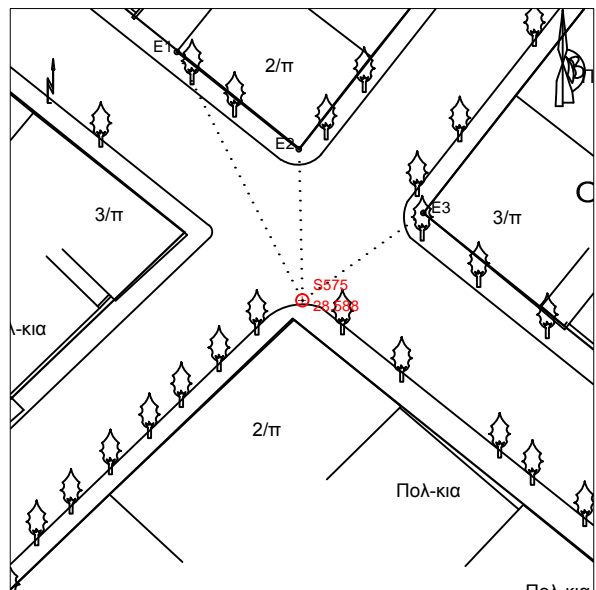

S575
 X= 409421.563
 Y= 4500798.645
 H= 28.588

E1= 20.29
 E2= 11.02
 E3= 10.9

S576
 X= 409441.388
 Y= 4500832.884
 H= 29.102

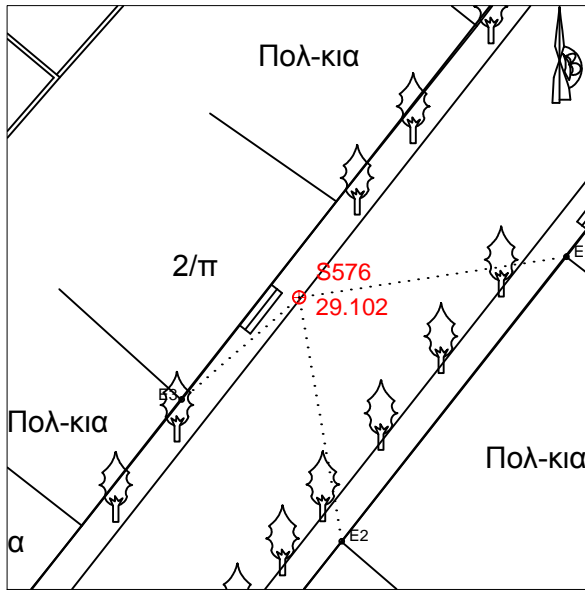

E1= 12.63
 E2= 11.57
 E3= 7.27

S577
 X= 409454.141
 Y= 4500784.234
 H= 28.945

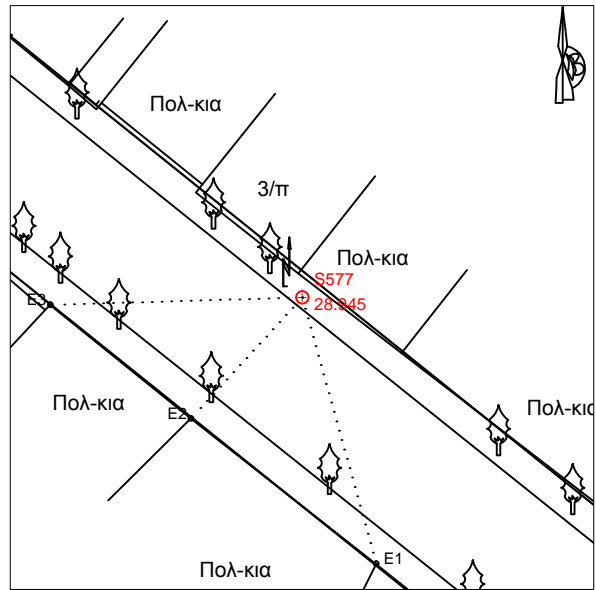

E1= 18.05
 E2= 10.72
 E3= 16.45

S578
 X= 409495.761
 Y= 4500889.631
 H= 30.401

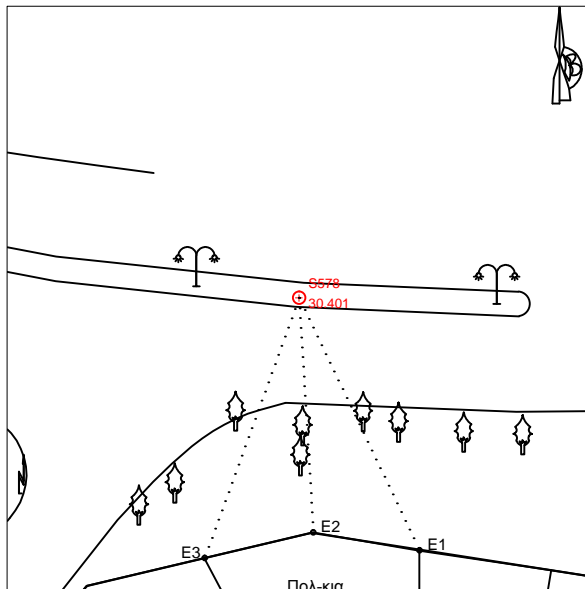

E1= 23.25
 E2= 19.53
 E3= 23

S579
 X= 409485.185
 Y= 4500753.835
 H= 29.288

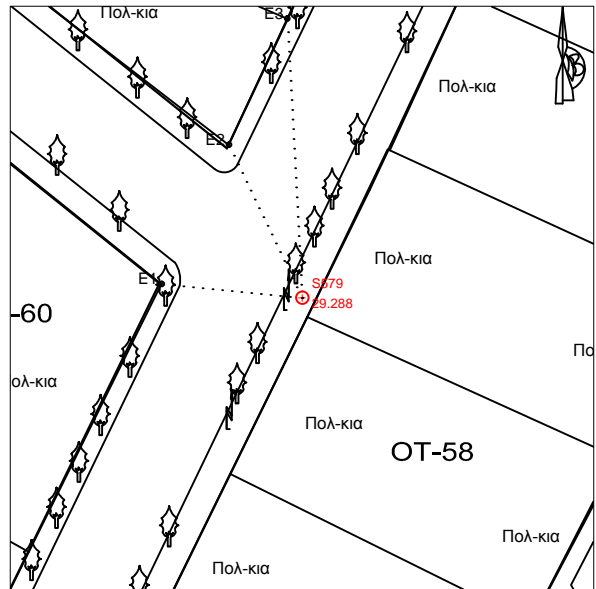

E1= 11.48
 E2= 13.8
 E3= 22.72

S580
 X= 409515.181
 Y= 4500838.151
 H= 30.718

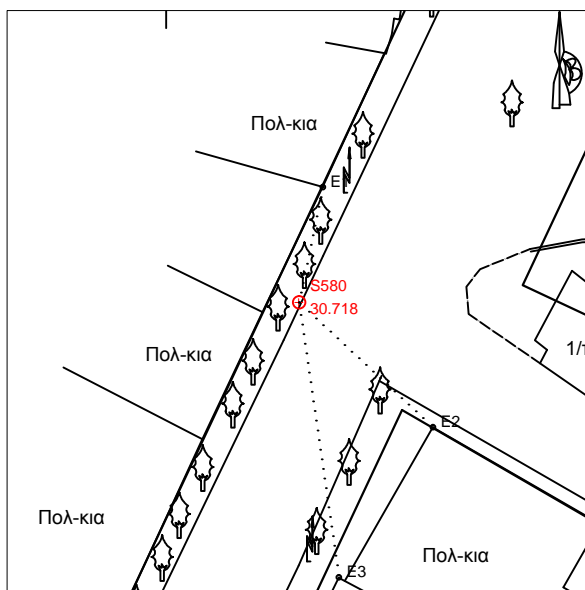

E1= 8.39
 E2= 13.04
 E3= 19.78

S581
 X= 409544.239
 Y= 4500818.99
 H= 30.809

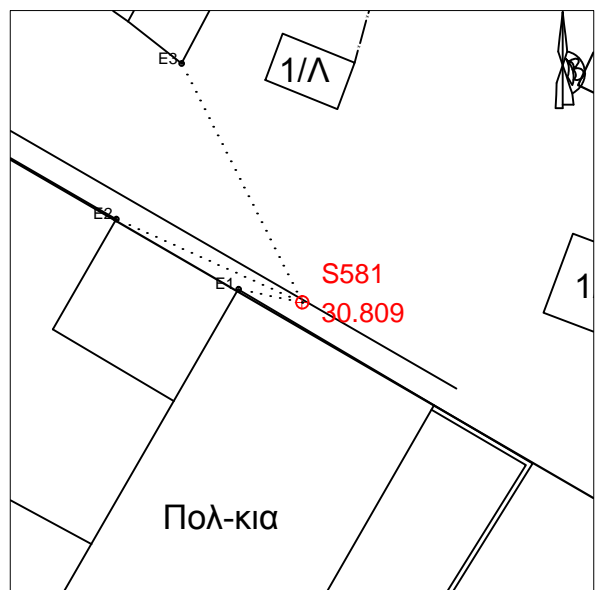

E1= 2.67
 E2= 8.35
 E3= 10.98

S582
 X= 409548.394
 Y= 4500846.759
 H= 31.952

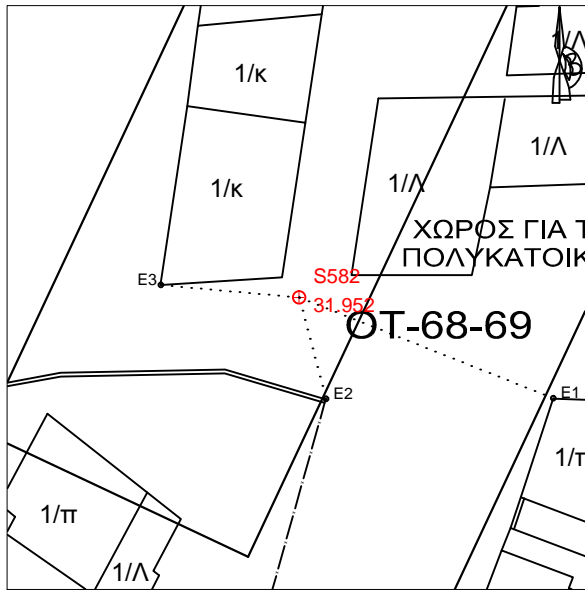

E1= 14.98
 E2= 5.76
 E3= 7.6

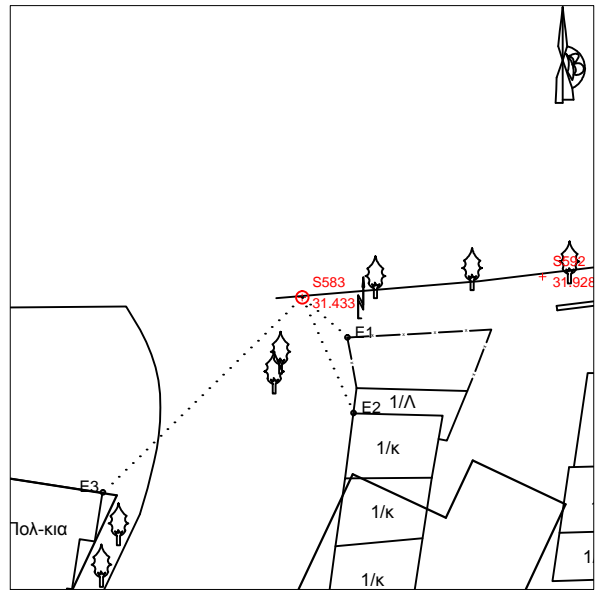

S583
 X= 409540.262
 Y= 4500880.986
 H= 31.433

E1= 4.71
 E2= 9.86
 E3= 21.73

S584
 X= 409094.605
 Y= 4501024.544
 H= 22.868

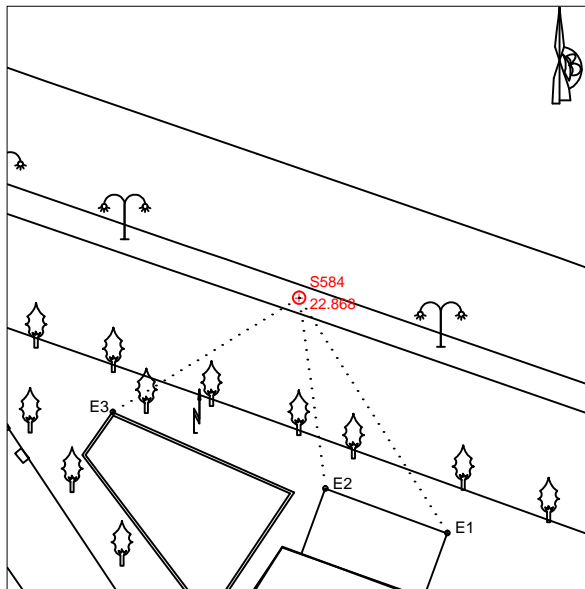

E1= 20.34
 E2= 14.07
 E3= 15.98

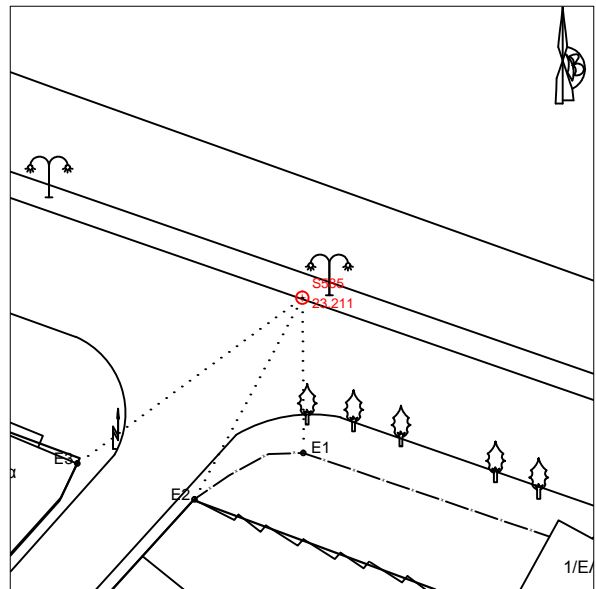

S585
 X= 409172.314
 Y= 4500996.61
 H= 23.211

E1= 12.43
 E2= 18.33
 E3= 22.41

S586
 X= 409137.117
 Y= 4500952.42
 H= 22.696

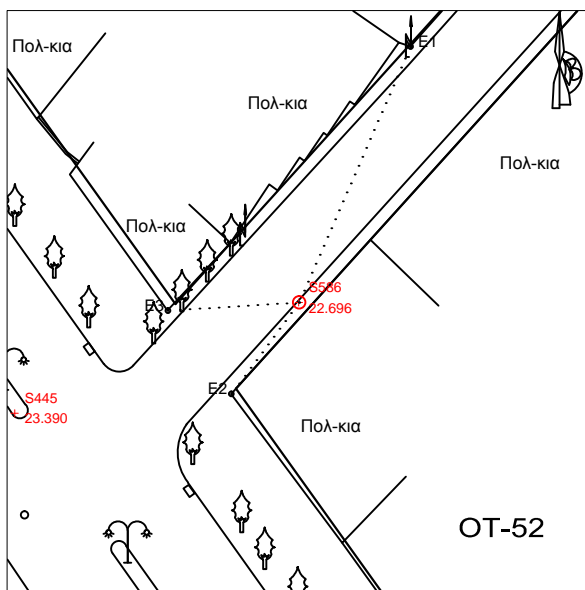

E1= 21.94
 E2= 8.96
 E3= 10.34

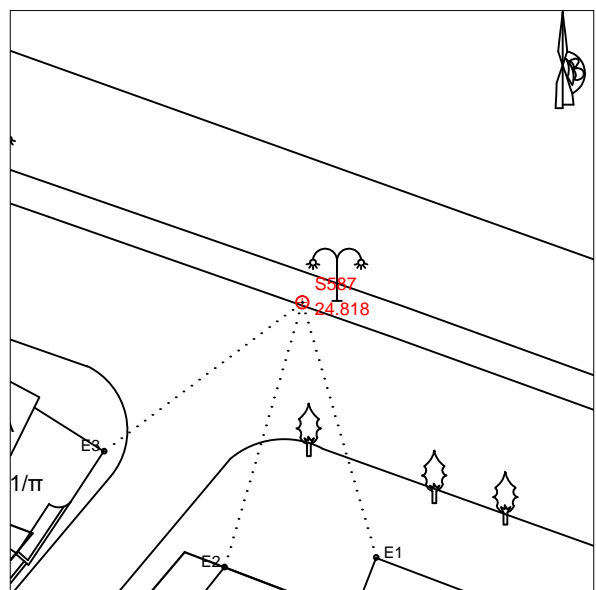

S587
 X= 409218.974
 Y= 4500980.516
 H= 24.818

E1= 16.56
 E2= 17.19
 E3= 15.44

S588
 X= 409255.44
 Y= 4500967.966
 H= 24.941

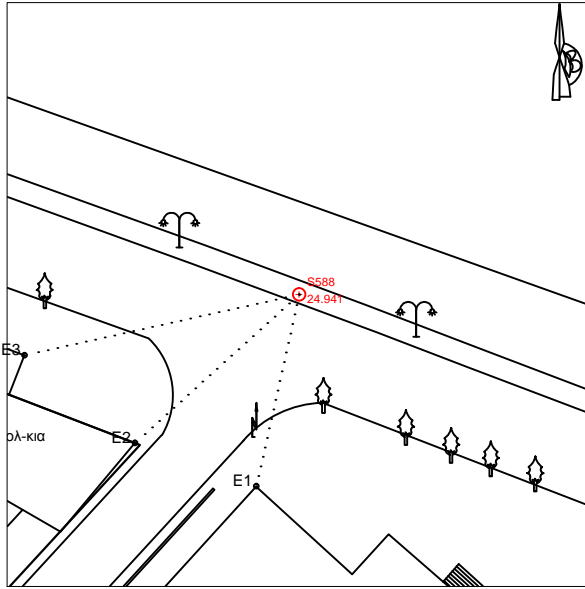

E1= 18.42
 E2= 20.73
 E3= 26.34

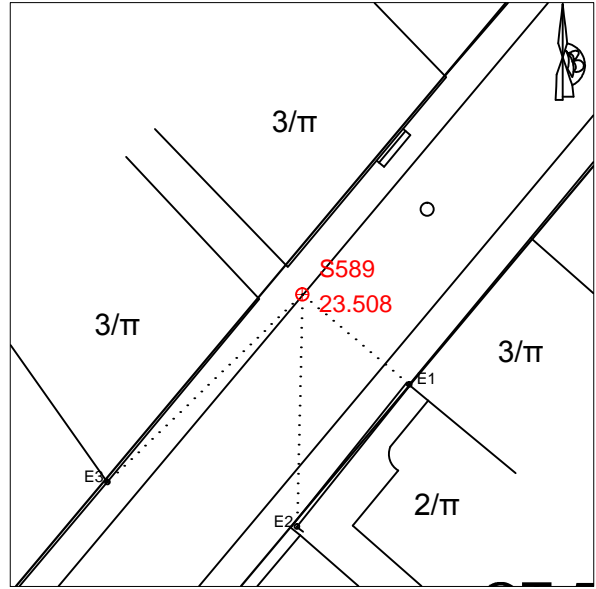

S589
 X= 409178.457
 Y= 4500935.594
 H= 23.508

E1= 6.49
 E2= 10.78
 E3= 12.56

S590
 X= 409156.162
 Y= 4500900.784
 H= 22.771

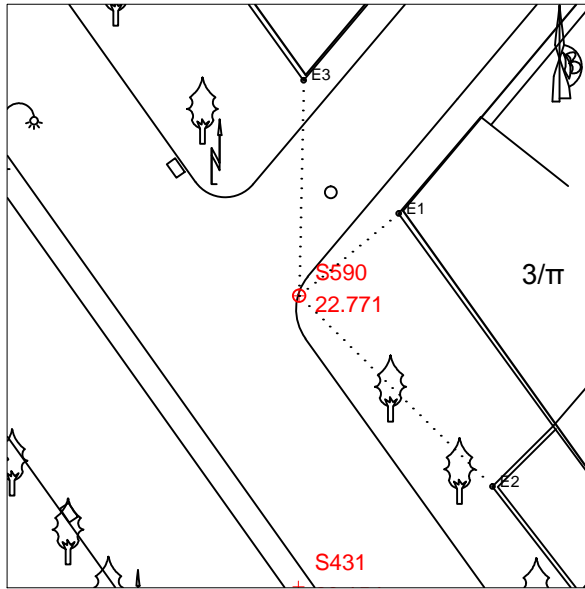

E1= 6.39
 E2= 13.45
 E3= 10.67

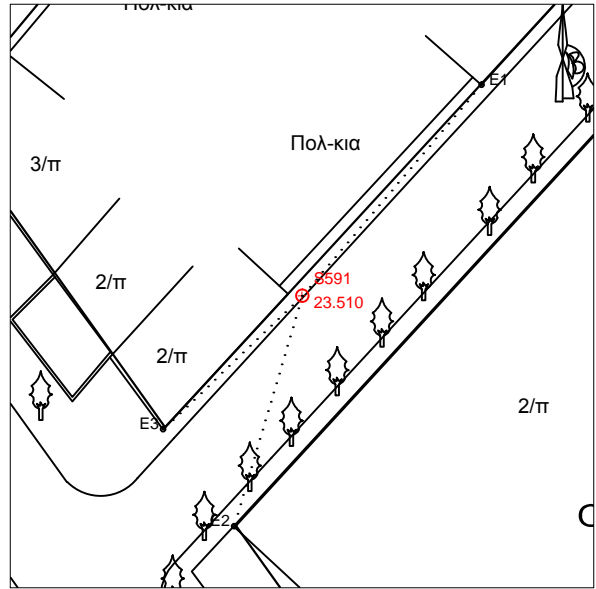

S591
 X= 409185.568
 Y= 4500892.913
 H= 23.510

E1= 18.72
 E2= 16.22
 E3= 13.03

S592
 X= 409558.997
 Y= 4500882.609
 H= 31.928

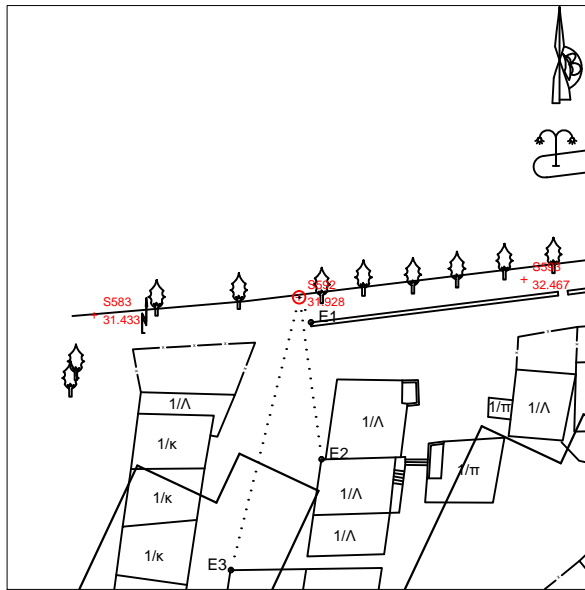

E1= 2.53
 E2= 14.97
 E3= 25.73

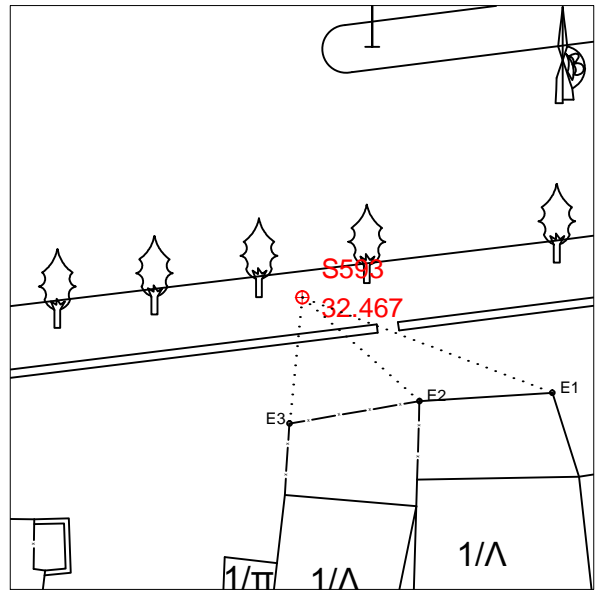

S593
 X= 409579.616
 Y= 4500884.236
 H= 32.467

E1= 11.14
 E2= 6.51
 E3= 5.26

S594
 X= 409624.874
 Y= 4500888.73
 H= 33.732

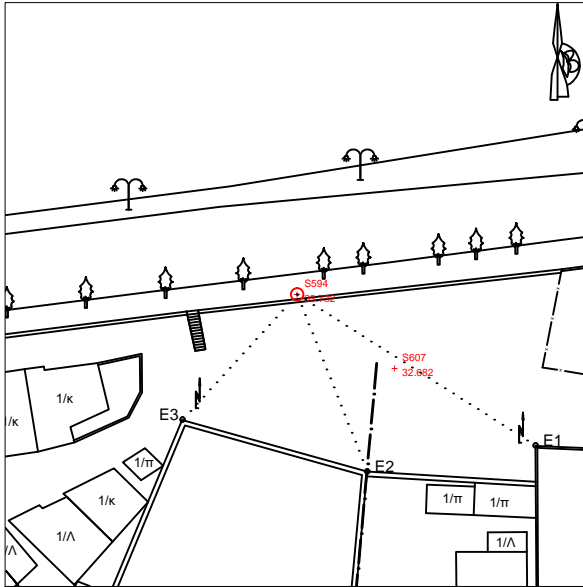

E1= 29.97
 E2= 20.21
 E3= 18.01

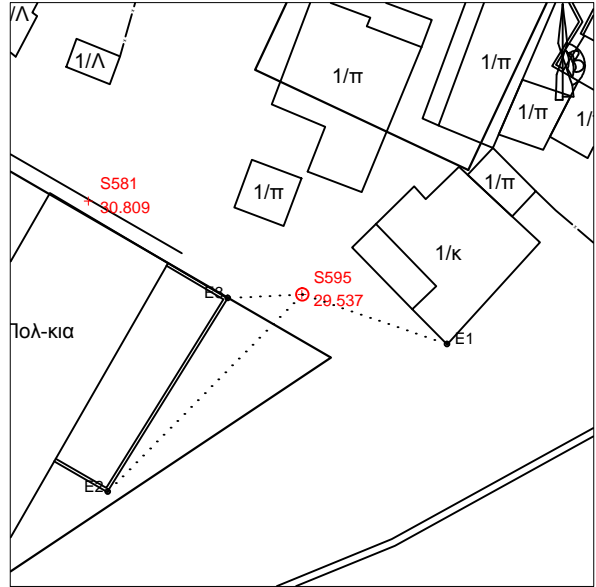

S595
 X= 409558.76
 Y= 4500812.643
 H= 29.537

E1= 10.42
 E2= 18.84
 E3= 5.07

S596
 X= 409519.51
 Y= 4500752.134
 H= 29.964

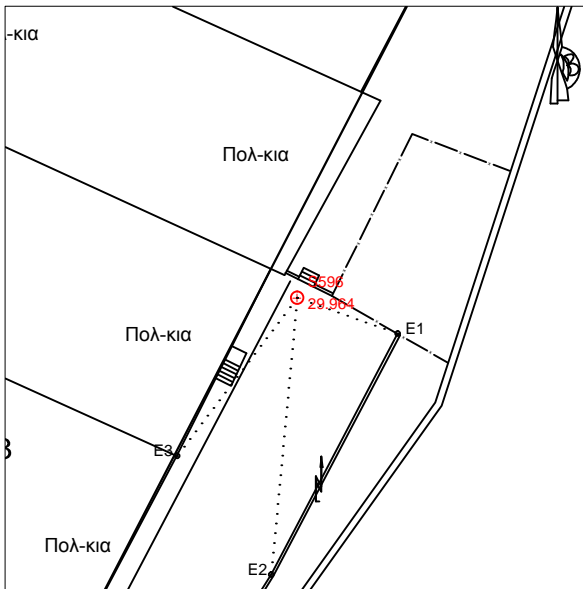

E1= 7.65
 E2= 19.88
 E3= 14.19

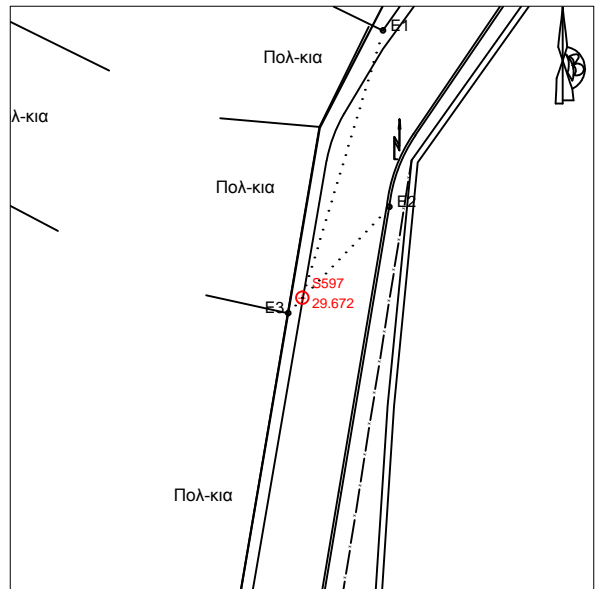

S597
 X= 409491.258
 Y= 4500692.385
 H= 29.672

E1= 22.29
 E2= 10.05
 E3= 1.65

S598
 X= 409483.465
 Y= 4500587.194
 H= 27.364

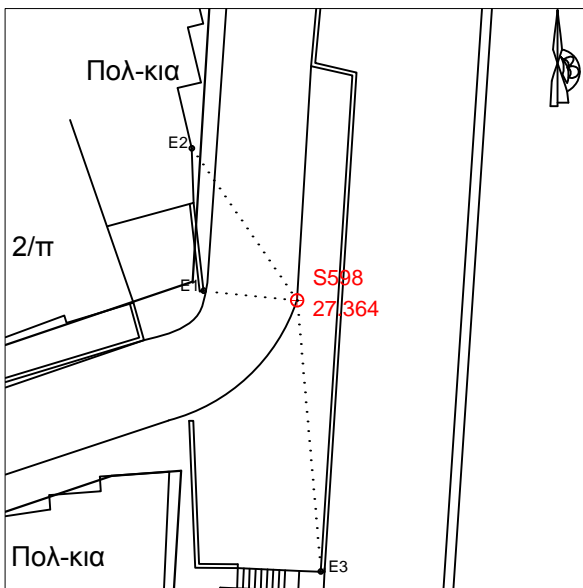

E1= 4.75
 E2= 9.38
 E3= 13.79

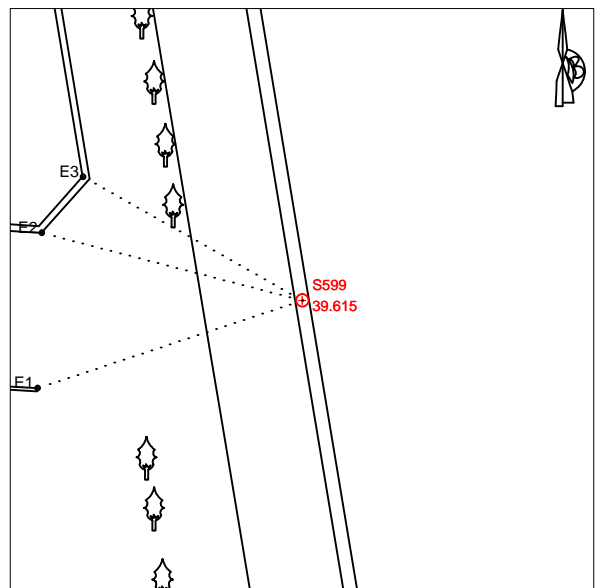

S599
 X= 409805.465
 Y= 4500592.795
 H= 39.615

E1= 21.15
 E2= 20.42
 E3= 19.1

S600
 X= 409781.537
 Y= 4500692.578
 H= 39.215

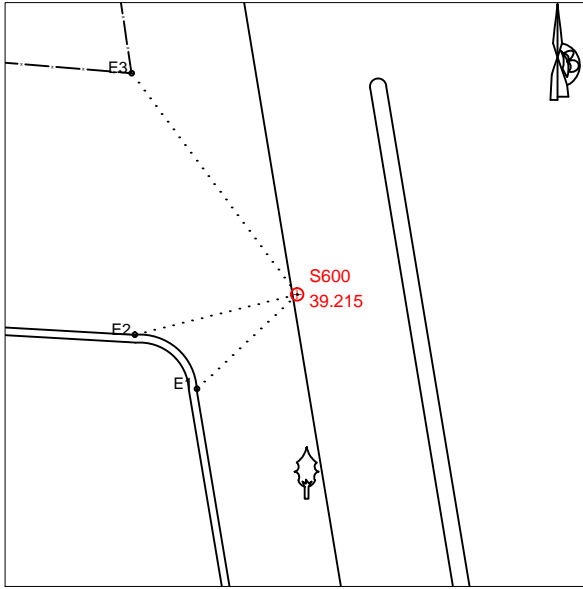

E1= 8.74
 E2= 10.61
 E3= 17.52

S602
 X= 409732.66
 Y= 4500705.133
 H= 38.646

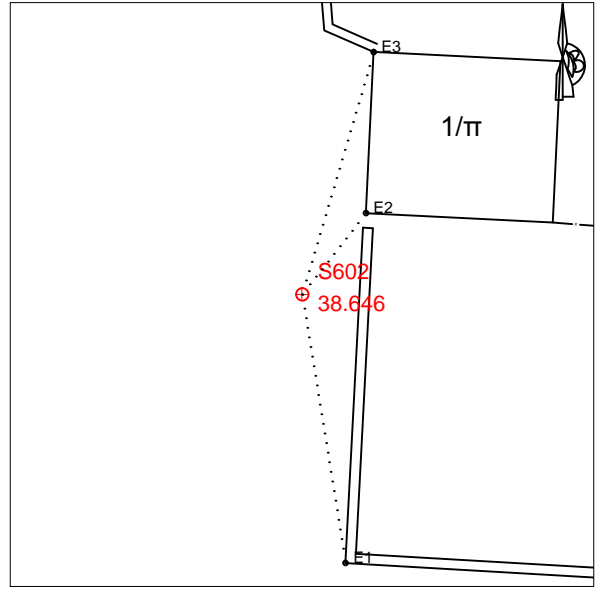

E1= 13.68
 E2= 5.2
 E3= 12.72

S601
 X= 409766.823
 Y= 4500825.861
 H= 37.331

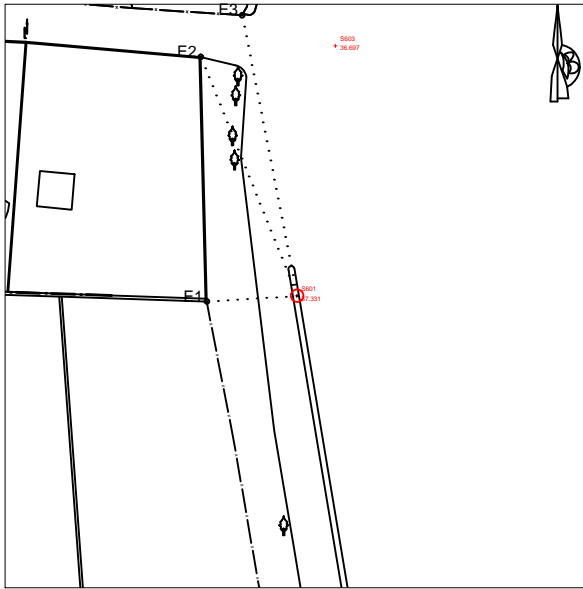

E1= 15.56
 E2= 44.33
 E3= 49.23

S603
 X= 409773.462
 Y= 4500868.918
 H= 36.697

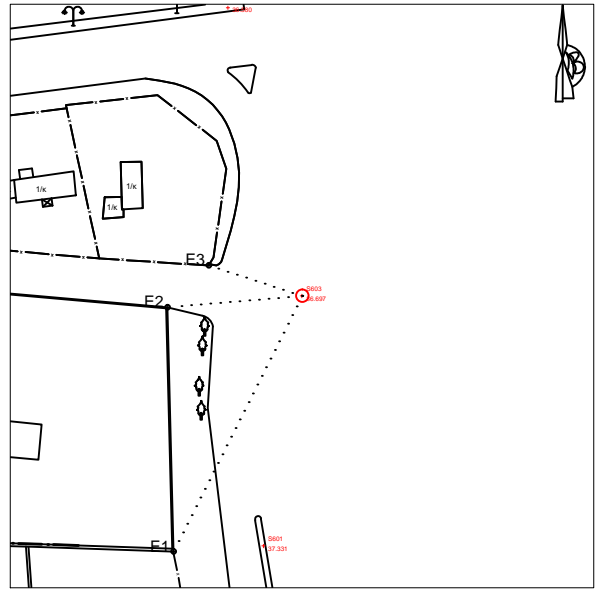

E1= 49.28
 E2= 23.29
 E3= 16.93

S604
 X= 409710.216
 Y= 4500874.916
 H= 35.559

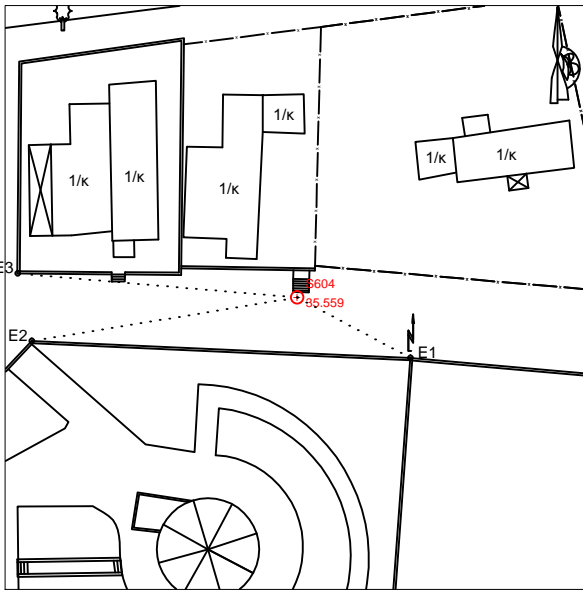

E1= 11.26
 E2= 23.55
 E3= 24.58

S605
 X= 409760.681
 Y= 4500918.576
 H= 36.580

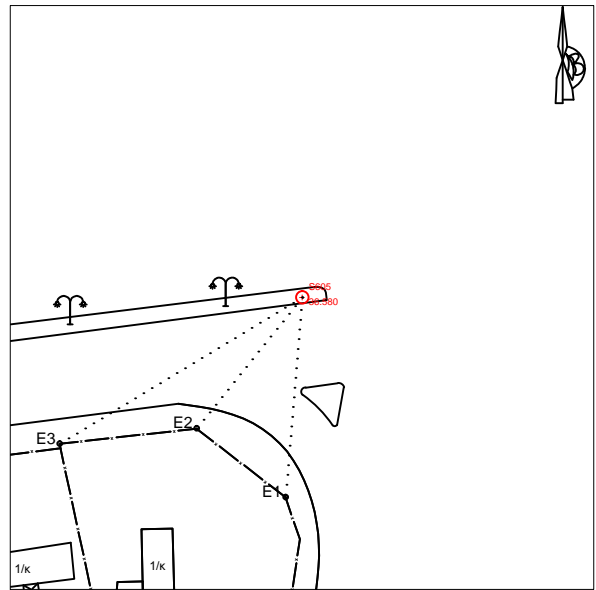

E1= 23.02
 E2= 19.32
 E3= 32.53

S606
X= 409693.593
Y= 4500917.926
H= 35.574

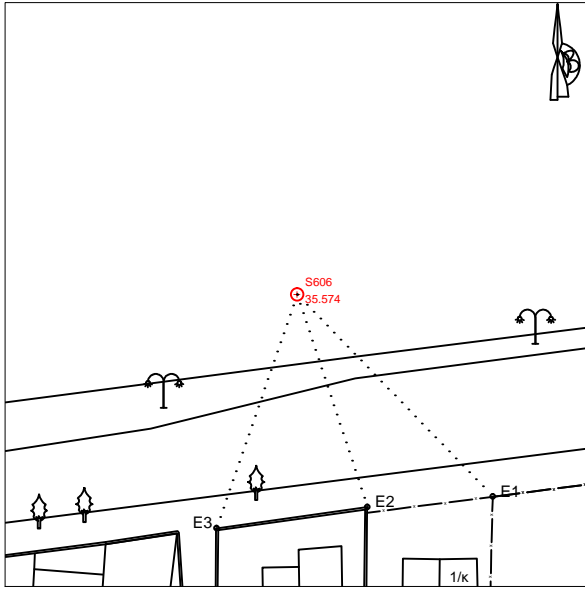

E1= 26.91
E2= 21.4
E3= 23.64

S607
X= 409635.249
Y= 4500880.9
H= 32.682

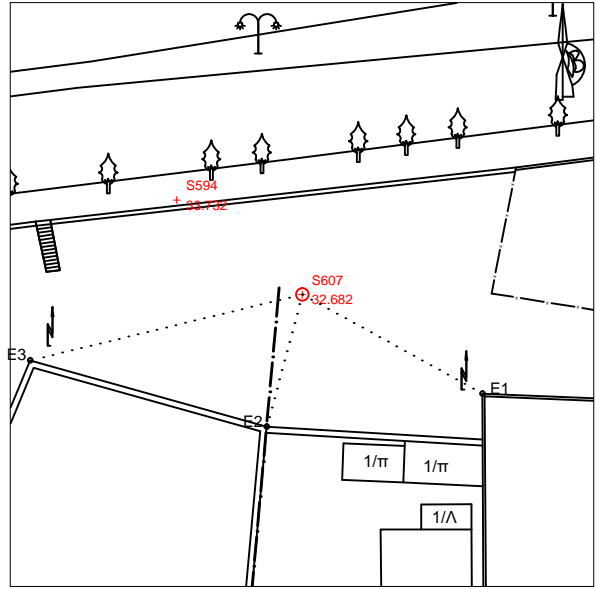

E1= 17.05
E2= 11.34
E3= 23.19

S608
X= 409676.191
Y= 4500871.428
H= 34.513



E1= 5.97
E2= 8.9
E3= 10.79