

ΤΕΥΧΟΣ ΕΞΑΣΦΑΛΙΣΕΩΝ ΣΤΑΣΕΩΝ



ΤΙΤΛΟΣ ΜΕΛΕΤΗΣ :

« ΥΨΟΜΕΤΡΙΚΗ ΜΕΛΕΤΗ ΟΔΩΝ ΤΩΝ Π.Ε 04
(ΔΗΜΑΡΧΕΙΟ) & Π.Ε. 05 (ΜΕΤΑΓΩΓΩΝ) ΤΗΣ
ΔΗΜΟΤΙΚΗΣ ΚΟΙΝΟΤΗΤΑΣ ΑΜΠΕΛΟΚΗΠΩΝ ΤΟΥ
ΔΗΜΟΥ ΑΜΠΕΛΟΚΗΠΩΝ ΜΕΝΕΜΕΝΗΣ »

Σ Π Υ Ρ Ι Δ Ο Π Ο Υ Λ Ο Σ Β. Γ Ρ Η Γ Ο Ρ Ι Ο Σ

Τ η λ. Γ ρ α φ ε ί ο υ : 2 3 1 0 7 2 5 9 0 0

Κ ι ν. 6 9 3 6 8 6 5 6 2 4

F a x : 2 3 1 0 7 2 5 9 0 0

Η μ ε ρ ο μ η ν ί α : 1 9 / 1 1 / 2 0 1 4

S341
X= 408828.547
Y=4500503.513
H= 16.681
E1= 14.42
E2= 7.53
E3= 8.45

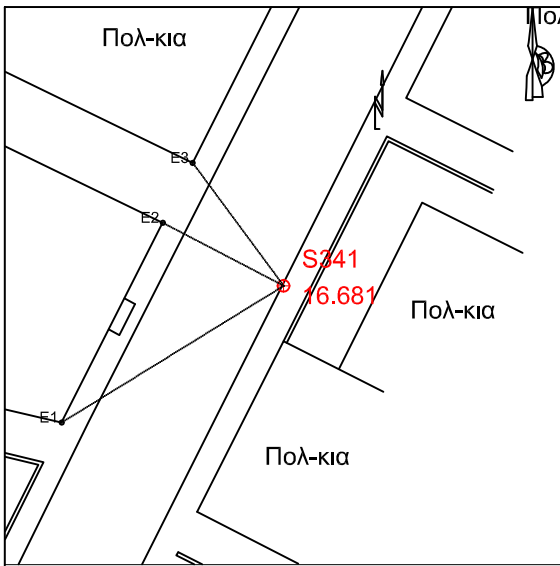

S342
X= 408849.36
Y=4500543.256
H=16.969
E1= 1.29
E2= 8.49
E3= 11.07

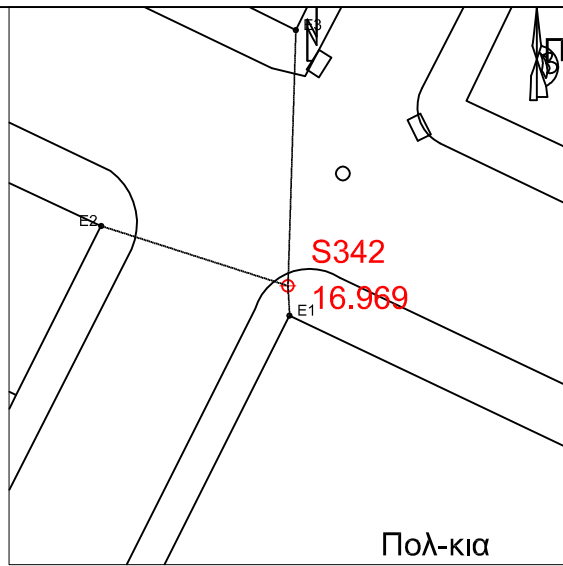

S343
X= 408877.99
Y=4500595.514
H= 17.052
E1= 20.14
E2= 11.79
E3= 7.02

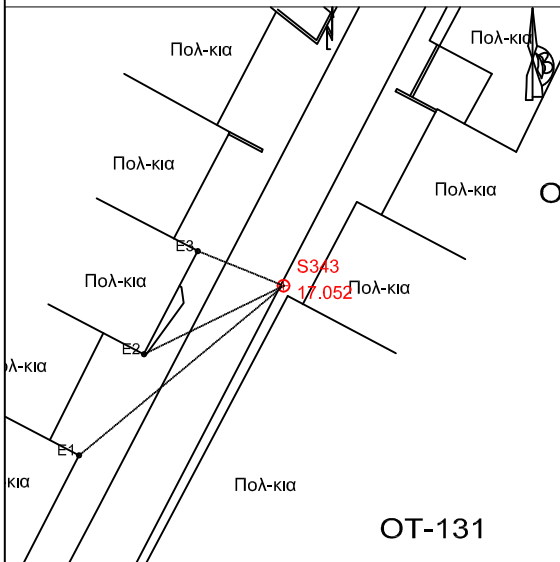

S344
X= 408893.893
Y= 4500531.42
H= 16.215
E1= 14.42
E2= 21.51
E3= 10.94

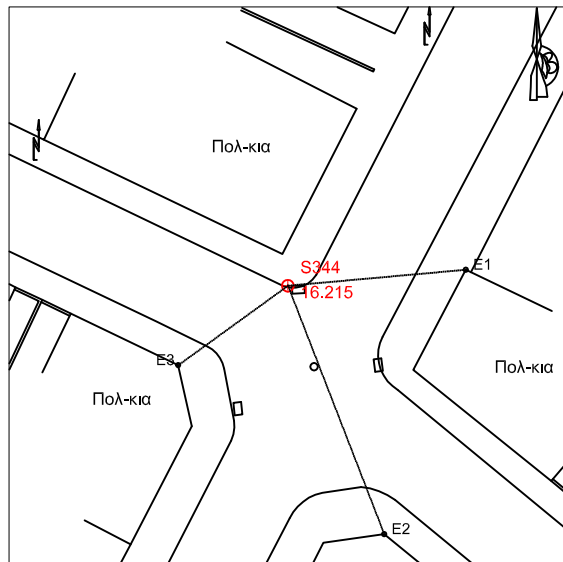

S345
X= 408894.229
Y=4500624.178
H= 17.552
E1= 20.87
E2= 14.3
E3= 17.18

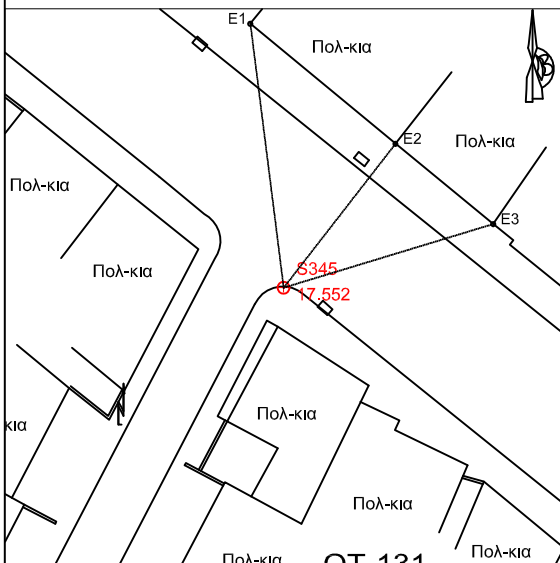

S346
X= 408876.154
Y=4500477.872
H= 16.011
E1= 12.49
E2= 10.59
E3= 13.11

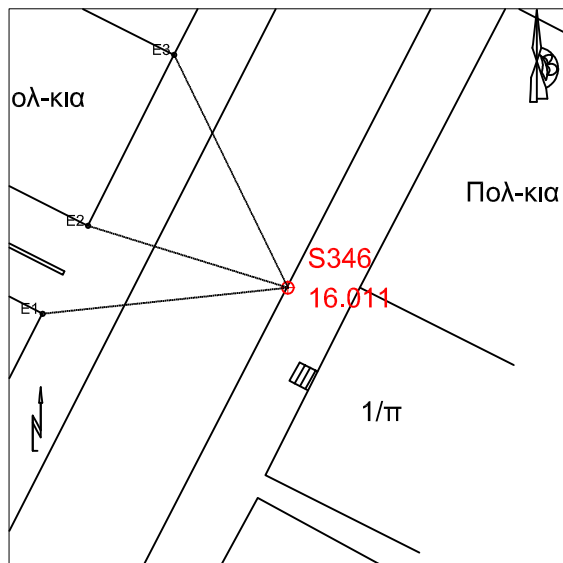

S347
 X= 408916.556
 Y=4500502.524
 H= 15.927
 E1= 13.21
 E2= 9.92
 E3= 19.24

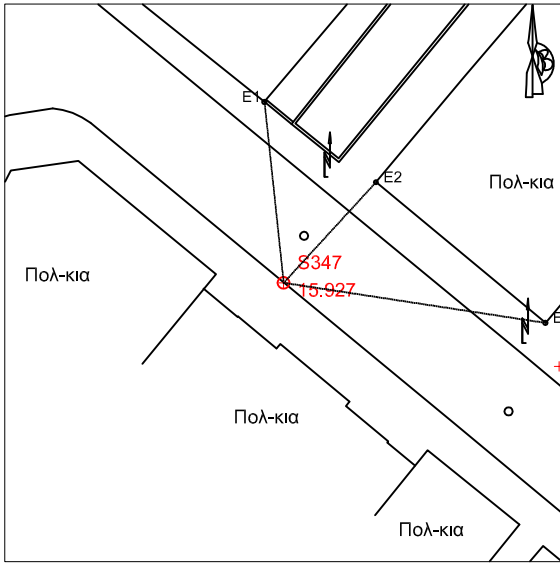

S348
 X= 408922.7
 Y=4500564.328
 H= 16.885
 E1= 14.44
 E2= 12.21
 E3= 20.24

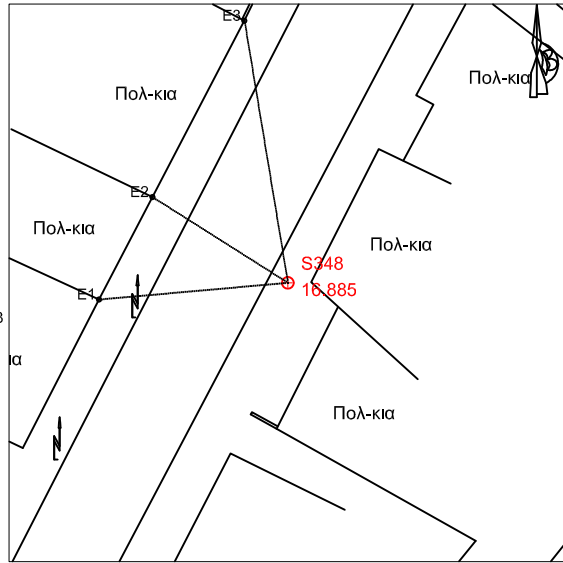

S349
 X= 408941.754
 Y=4500601.121
 H= 17.697
 E1= 15.25
 E2= 16.96
 E3= 13.1

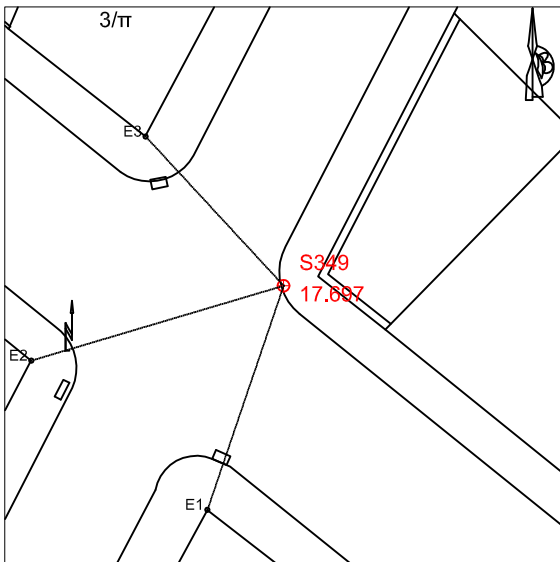

S350
 X= 408936.559
 Y=4500496.455
 H= 16.162
 E1= 11.83
 E2= 11.33
 E3= 20.31

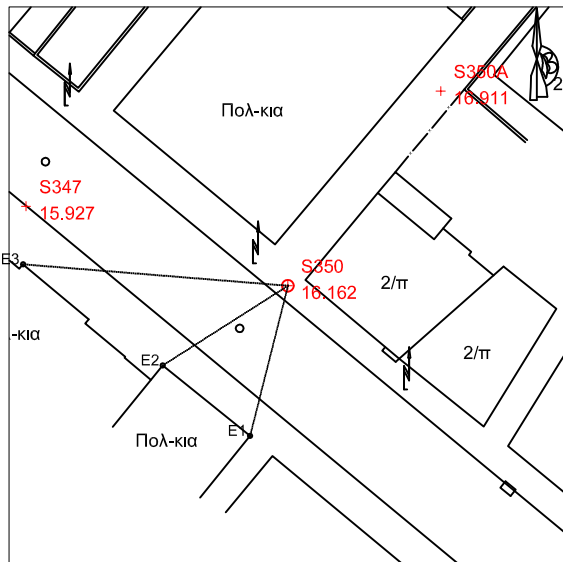

S350A
 X= 408948.235
 Y=4500511.324
 H= 16.911
 E1= 17.25
 E2= 5.67
 E3= 11.68

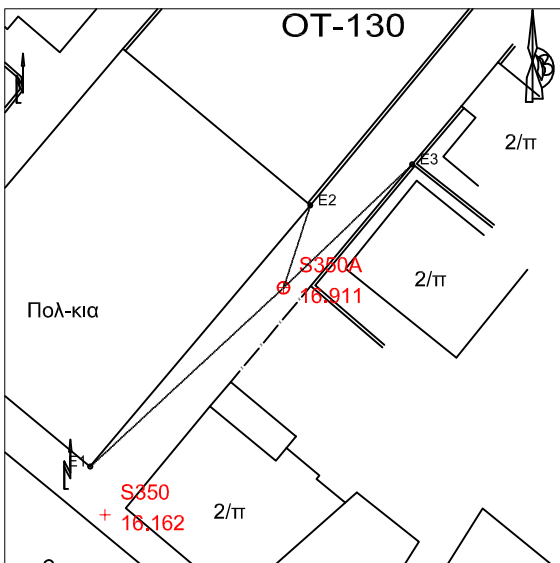

S351
 X= 408959.1
 Y=4500466.694
 H= 15.869
 E1= 10.75
 E2= 6.15
 E3= 12.94

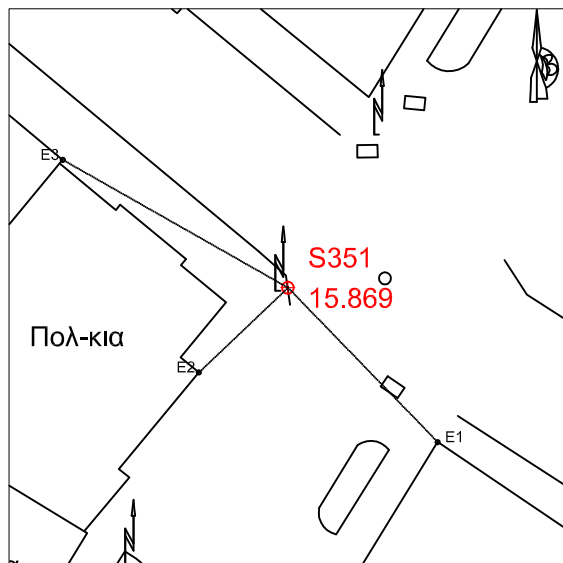

S352
 X= 408990.386
 Y=4500503.084
 H= 16.582
 E1= 10.88
 E2= 9.16
 E3= 9.68

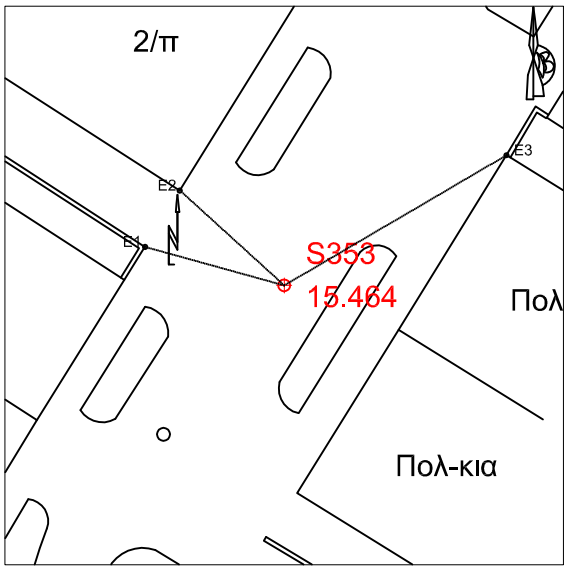
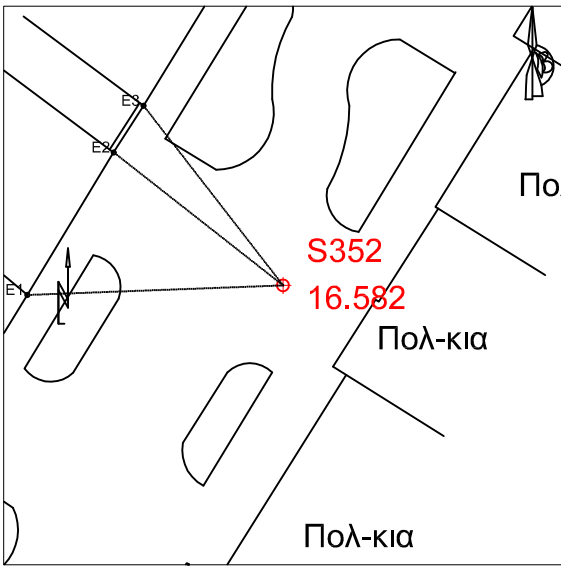

S353
 X= 408944.517
 Y=4500434.036
 H= 15.464
 E1= 6.68
 E2= 6.53
 E3= 11.92

S354
 X= 408998.638
 Y=4500448.832
 H= 15.899
 E1= 12.85
 E2= 9.23
 E3= 15.95

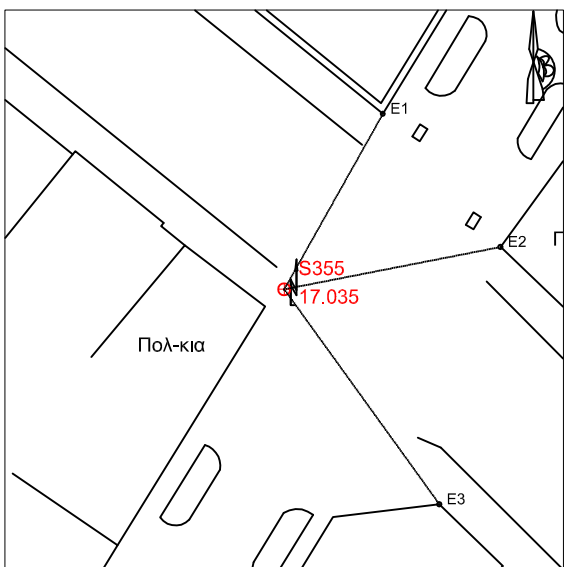
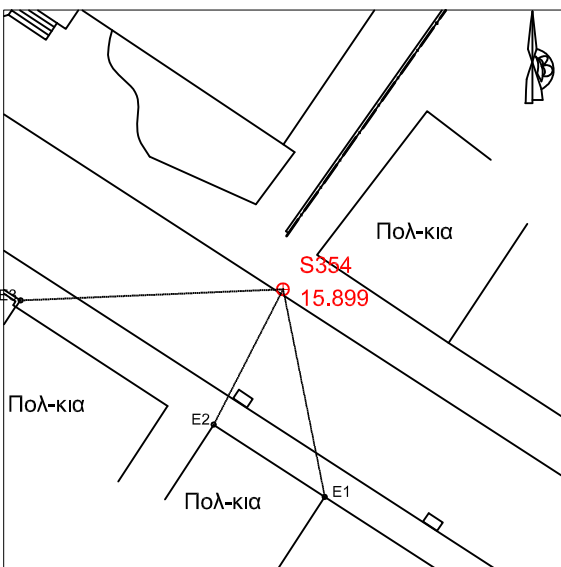

S355
 X= 409001.498
 Y=4500537.421
 H= 17.035
 E1= 14.16
 E2= 15.51
 E3= 18.64

S356
 X= 408920.81
 Y=4500401.159
 H= 14.808
 E1= 11.27
 E2= 13.68
 E3= 19.36

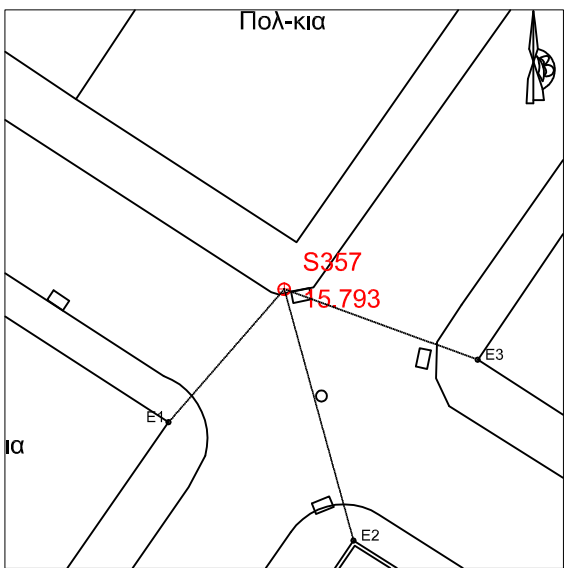
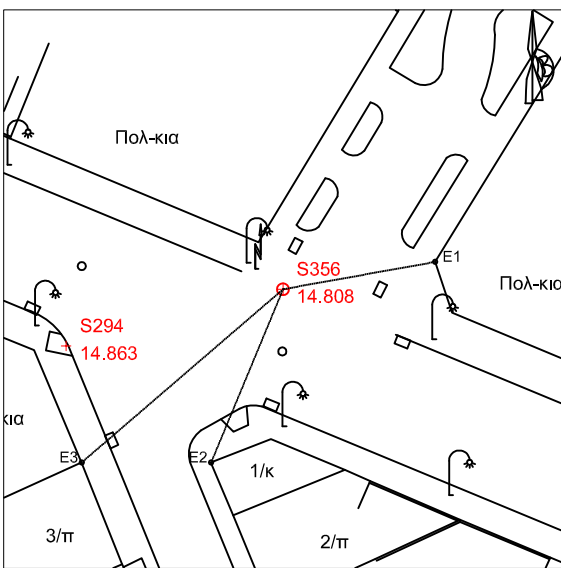

S357
 X= 409019.944
 Y=4500435.315
 H= 15.793
 E1= 9.53
 E2= 14.1
 E3= 11.13

S358
X= 409094.003
Y=4500377.322
H= 15.336
E1= 14.04
E2= 16.15
E3= 19.53

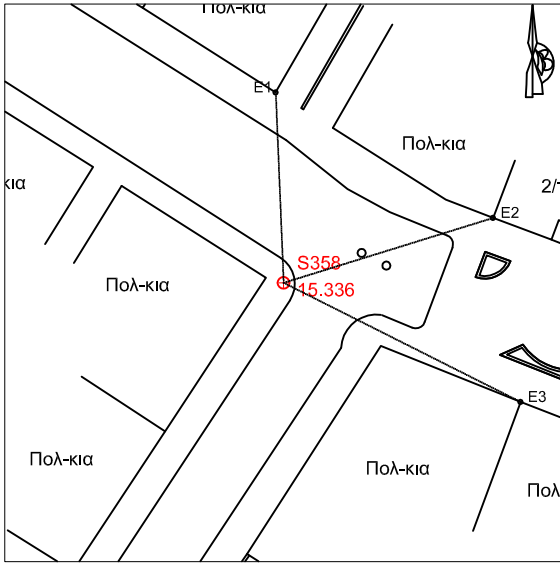

S359
X= 409053.16
Y=4500482.973
H= 16.739
E1= 20.88
E2= 12.16
E3= 16.14

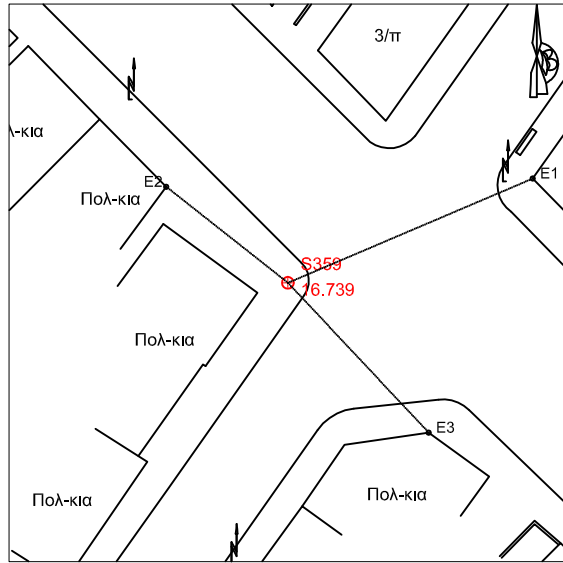

S360
X= 409006.67
Y=4500402.192
H= 15.539
E1= 11.61
E2= 11.86
E3= 14.49

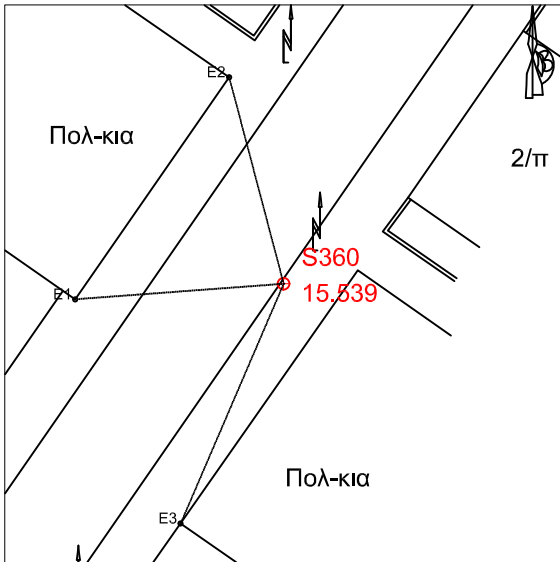

S361
 X= 409130.002
 Y= 4500369.09
 H= 15.720
 E1= 10.2
 E2= 7.43
 E3= 18.56

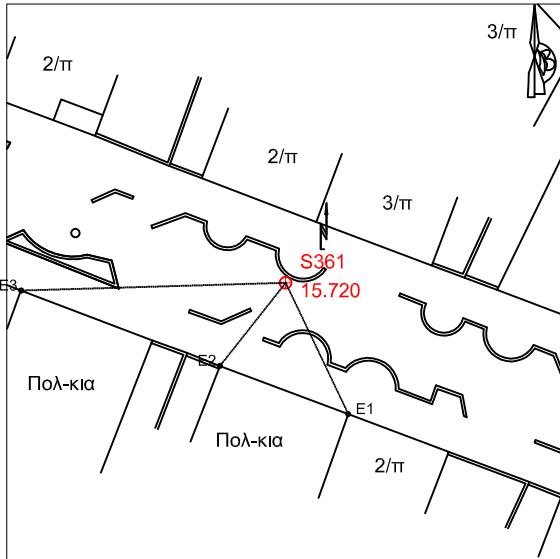

S362
 X= 409172.082
 Y= 4500358.44
 H= 15.627
 E1= 28.1
 E2= 24.93
 E3= 15.06

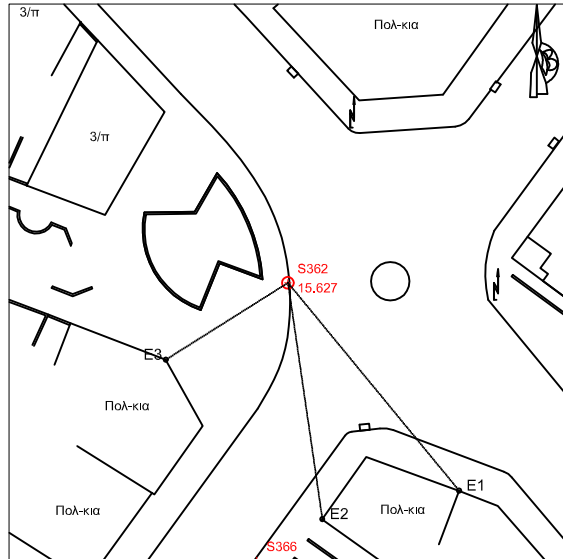

S363
 X= 409133.967
 Y=4500425.943
 H= 16.294
 E1= 22.43
 E2= 16.16
 E3= 23.68

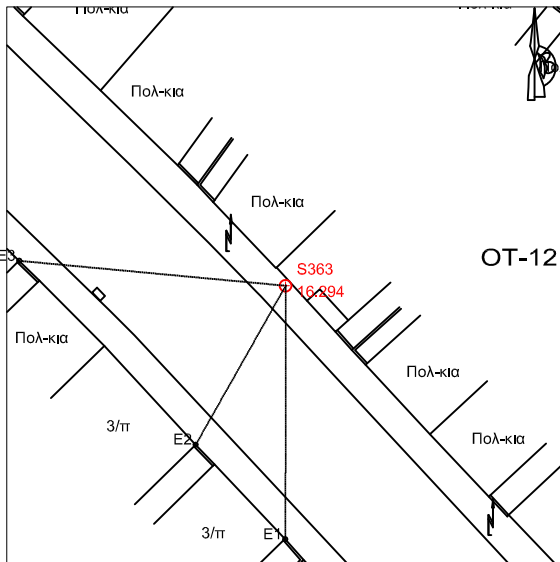

S364
 X= 409223.97
 Y=4500404.258
 H= 16.984
 E1= 19.8
 E2= 14.42
 E3= 13.97

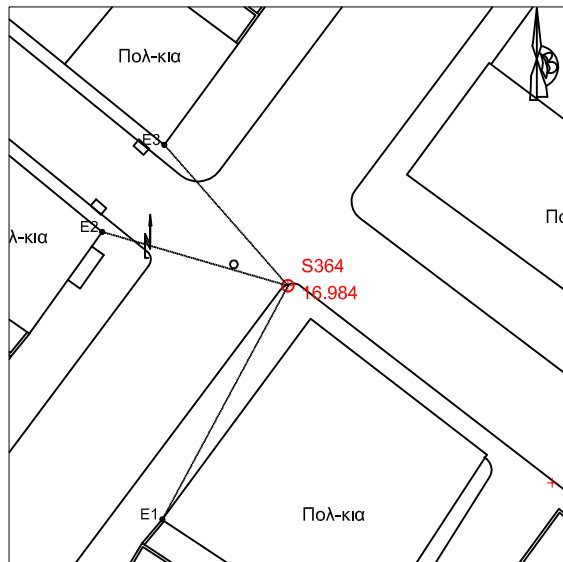

S364A
 X= 409181.077
 Y=4500441.054
 H= 17.188
 E1= 15.58
 E2= 11.95
 E3= 8.27

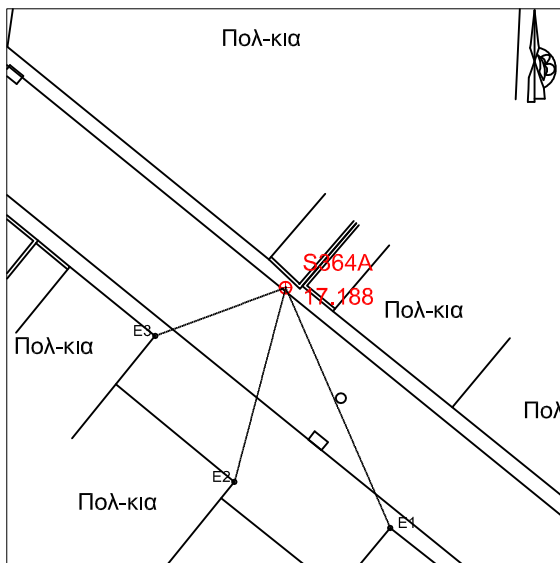

S365
 X= 409203.297
 Y=4500328.636
 H= 15.602
 E1= 10.68
 E2= 3.49
 E3= 11.36

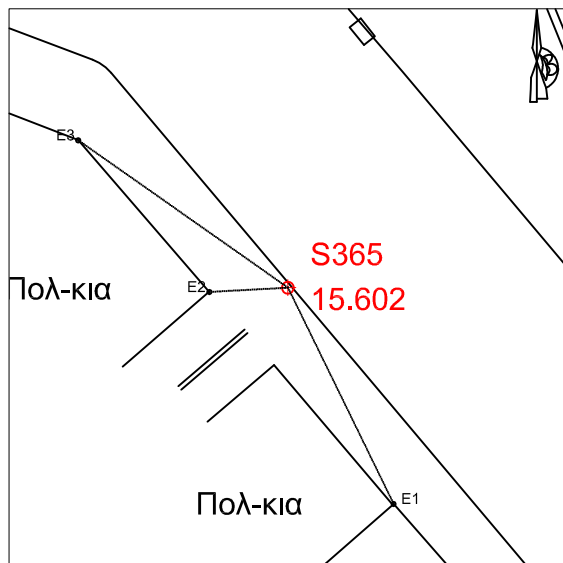

S366
X= 409168.836
Y=4500329.464
H= 14.935
E1= 15.72
E2= 11.63
E3= 12.7

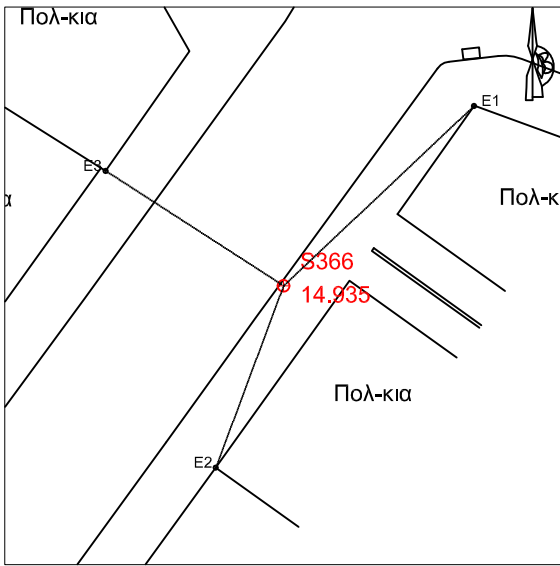

S367
X= 409097.434
Y=4500462.195
H= 16.663
E1= 18.41
E2= 15.7
E3= 18

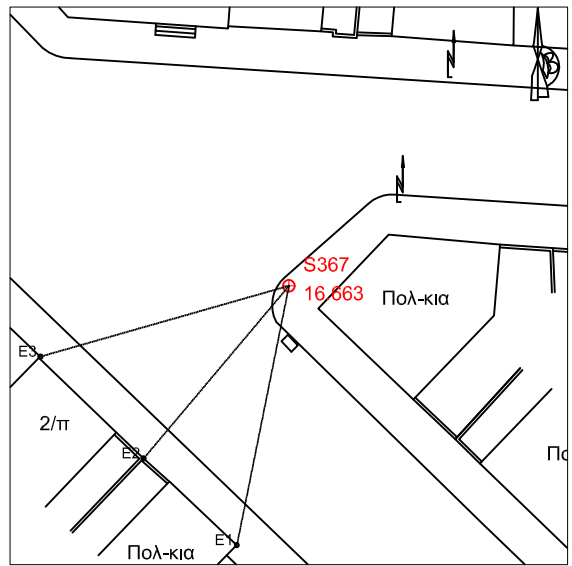

S368
X= 409123.88
Y= 4500476.77
H= 17.336
E1= 22.19
E2= 13.43
E3= 16.58

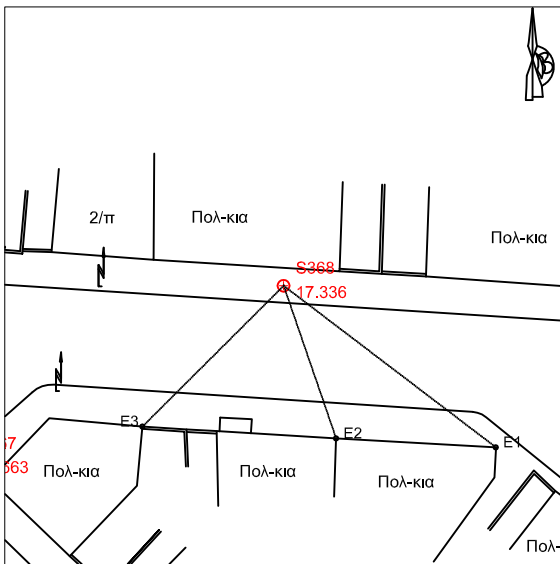

S369
X= 409102.466
Y=4500536.184
H= 18.126
E1= 17.35
E2= 12.57
E3= 20.33

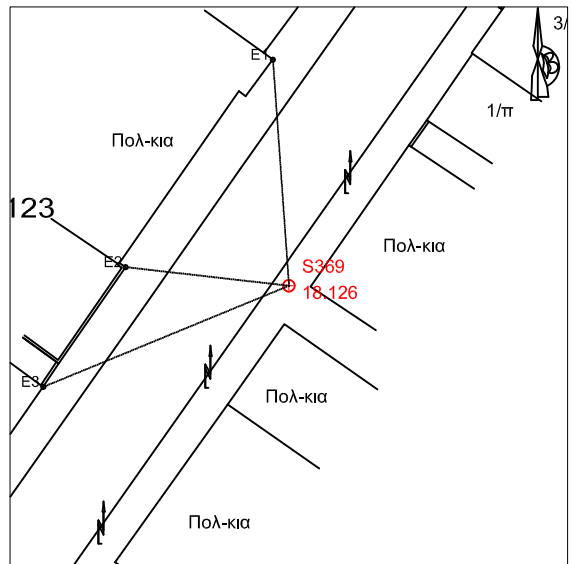

S370
X= 409035.307
Y=4500519.353
H= 16.911
E1= 17.48
E2= 14.63
E3= 18.33

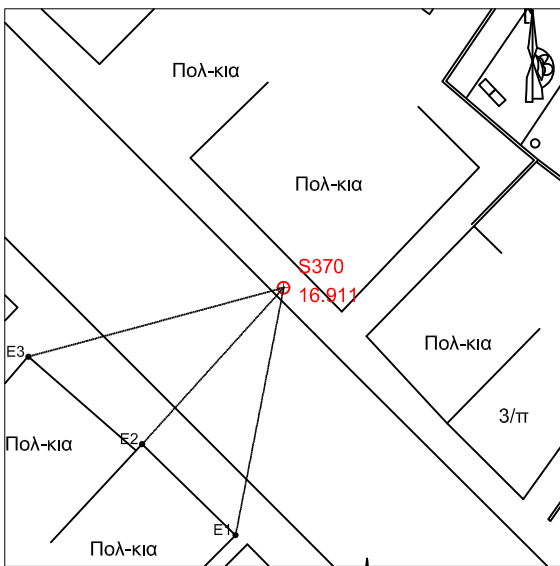

S371
X= 409048.911
Y= 4500593.71
H= 18.623
E1= 12.67
E2= 12.67
E3= 7.28

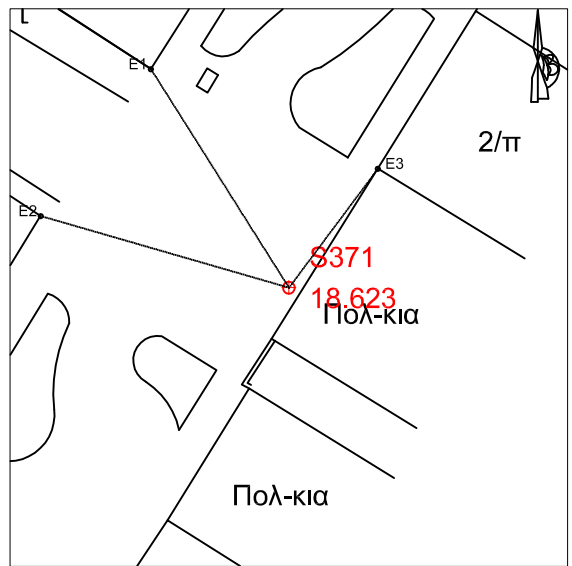

S372
 X= 408971.208
 Y=4500577.458
 H= 17.457
 E1= 16.28
 E2= 16.59
 E3= 23.36

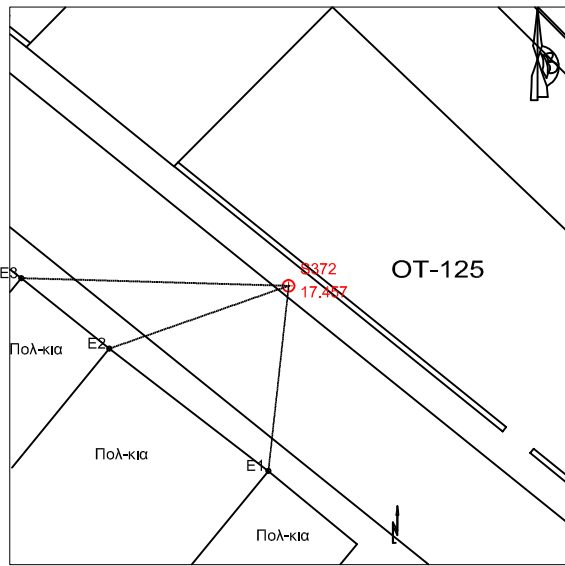

S373
 X= 408957.557
 Y= 4500651.64
 H= 18.497
 E1= 17.04
 E2= 11.57
 E3= 18.03

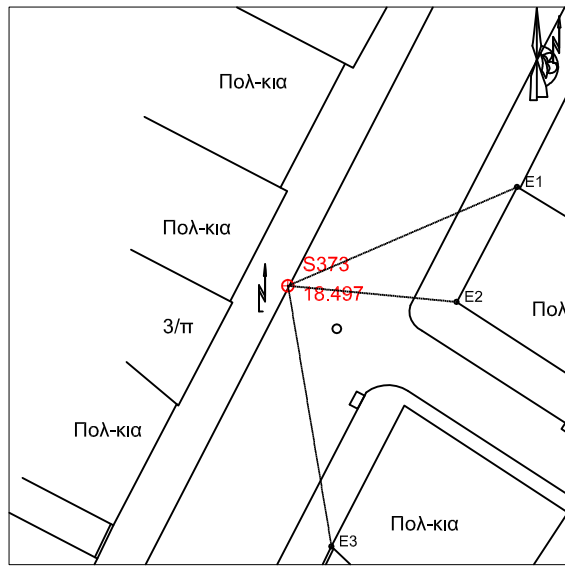

S374
 X= 408939.148
 Y=4500708.229
 H= 19.358
 E1= 11.53
 E2= 13.88
 E3= 30.63

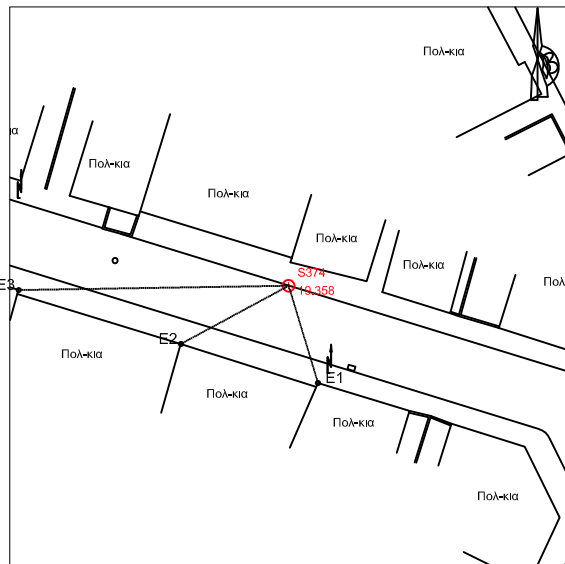

S375
 X= 408981.475
 Y=4500679.585
 H= 18.963
 E1= 11.84
 E2= 22.06
 E3= 11.8

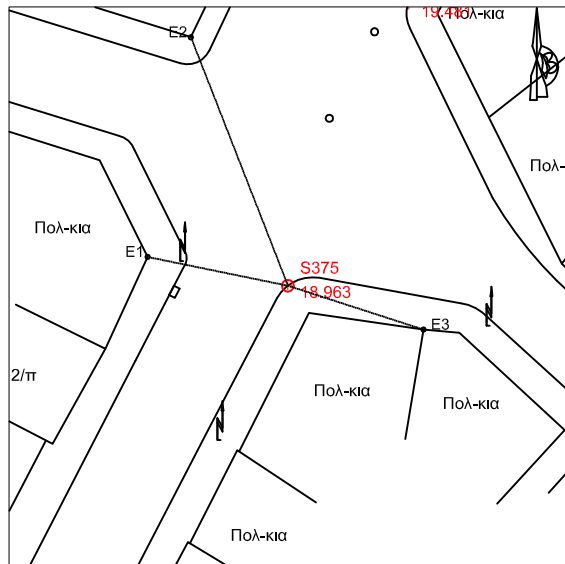

S376
 X= 408991.482
 Y=4500702.791
 H= 19.481
 E1= 15.14
 E2= 19.76
 E3= 26.86

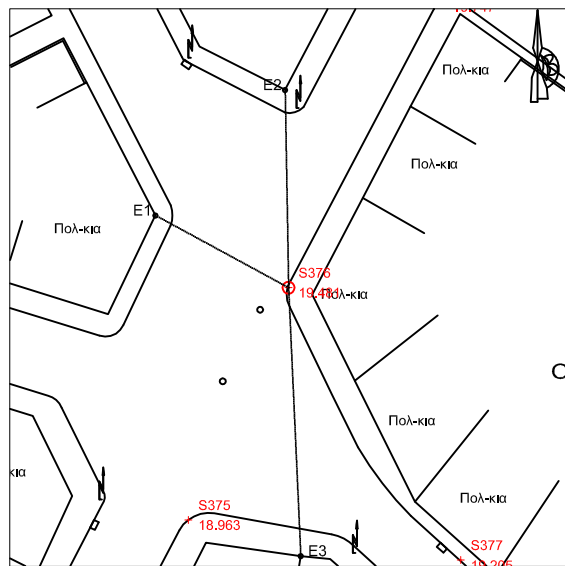

S377
 X= 409008.675
 Y=4500675.572
 H= 19.205
 E1= 9.02
 E2= 13.02
 E3= 7.39

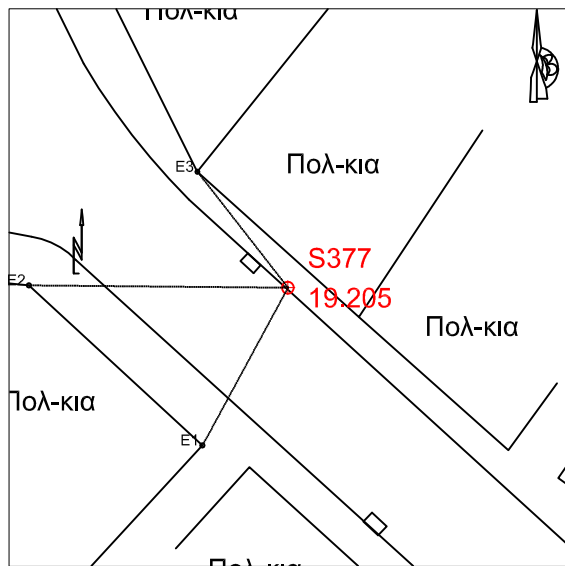

S378
 X= 409011.602
 Y=4500619.706
 H= 18.567
 E1= 5.87
 E2= 7.92
 E3= 26.2

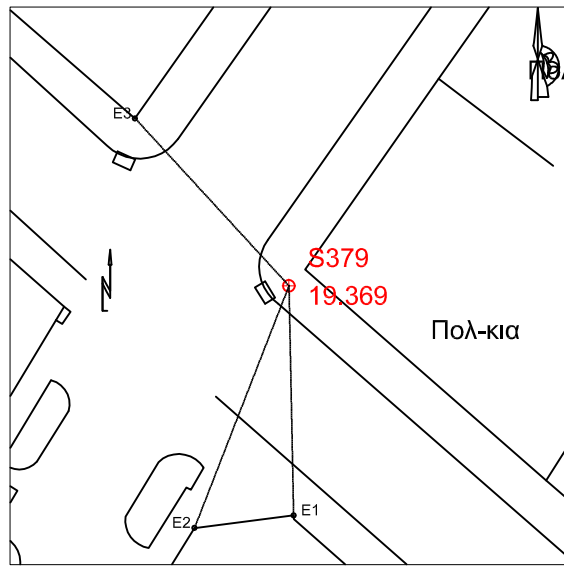
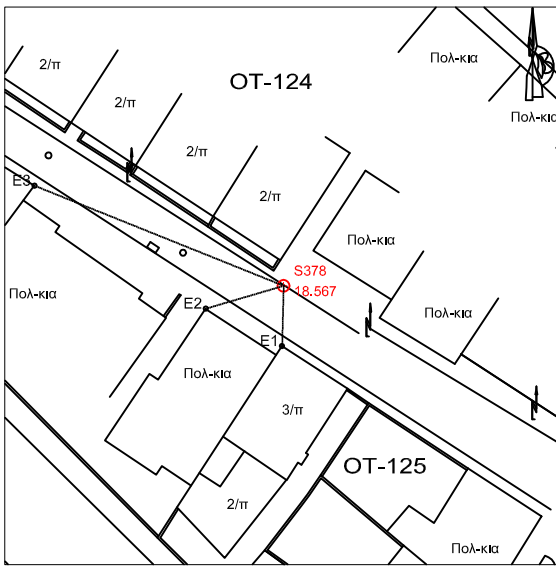

S379
 X= 409065.918
 Y=4500624.744
 H= 19.369
 E1= 12.14
 E2= 13.74
 E3= 12.03

S380
 X= 409027.272
 Y=4500650.224
 H= 19.230
 E1= 11.69
 E2= 7.47
 E3= 10.11

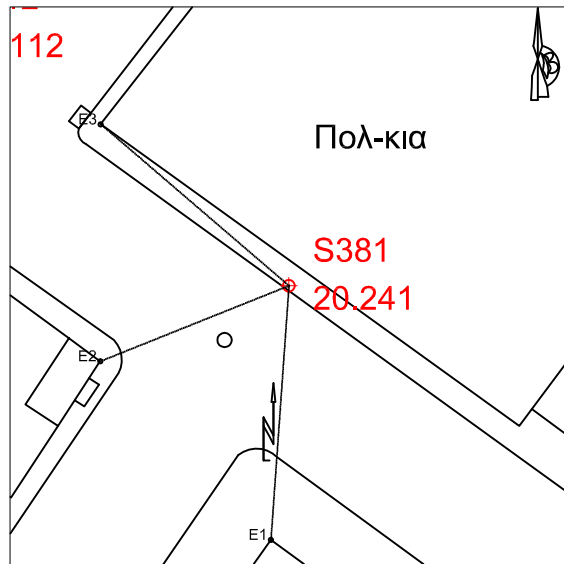
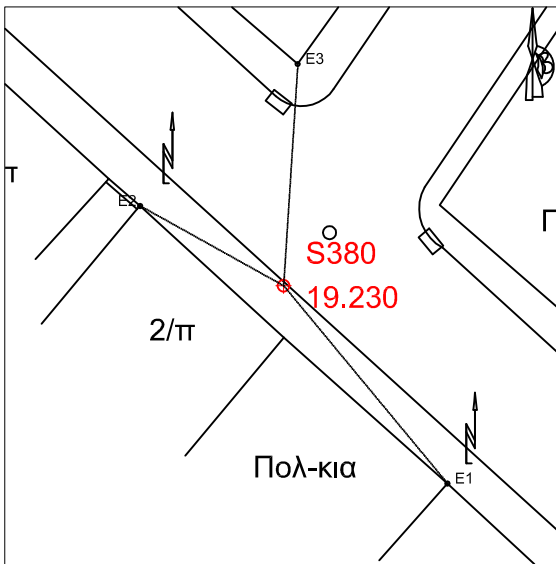

S381
 X= 409062.053
 Y=4500700.452
 H= 20.241
 E1= 10.6
 E2= 8.45
 E3= 10.32

S382
 X= 409096.414
 Y=4500598.283
 H= 19.343
 E1= 15.25
 E2= 12.62
 E3= 21.03

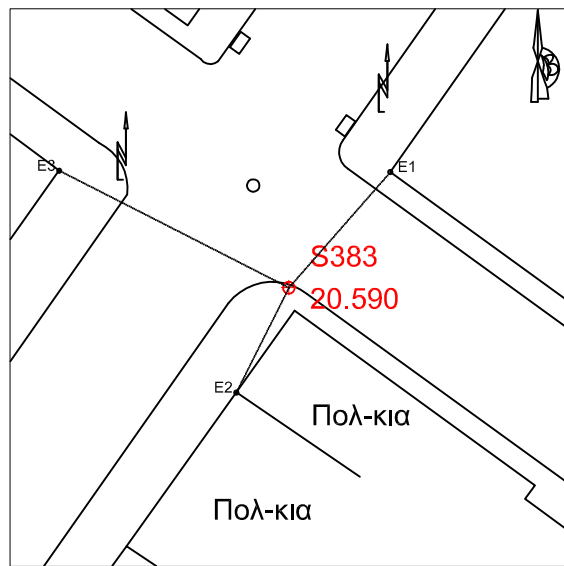
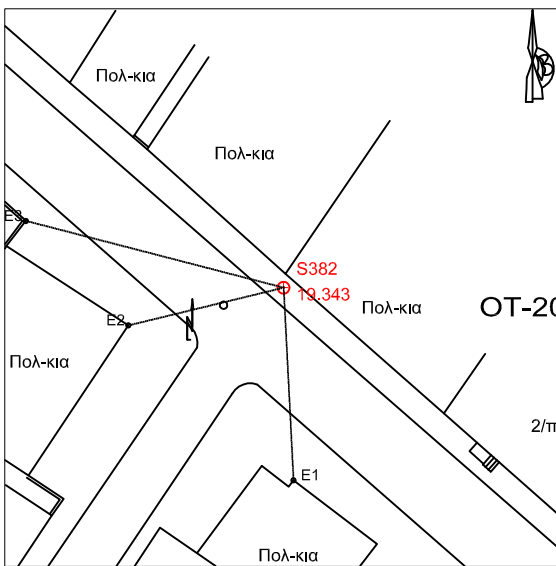

S383
 X= 409095.792
 Y=4500668.014
 H= 20.590
 E1= 7.34
 E2= 5.59
 E3= 12.3

S384
X= 409127.136
Y=4500570.434
H= 19.180
E1= 8.52
E2= 14.62
E3= 11.43

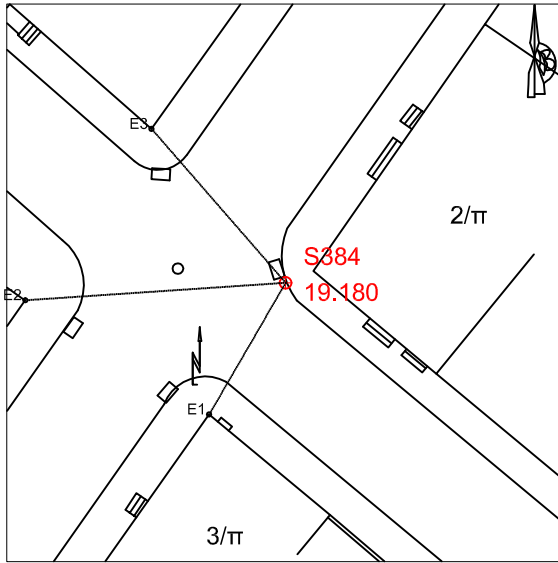

S385
X= 409054.747
Y=4500542.612
H= 17.977
E1= 7.93
E2= 8.26
E3= 15.64

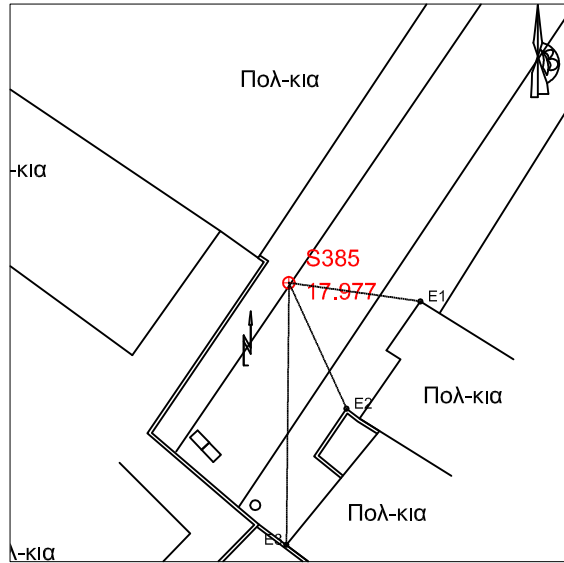

S386
X= 409163.709
Y=4500529.859
H= 18.928
E1= 11.6
E2= 15.26
E3= 22.96

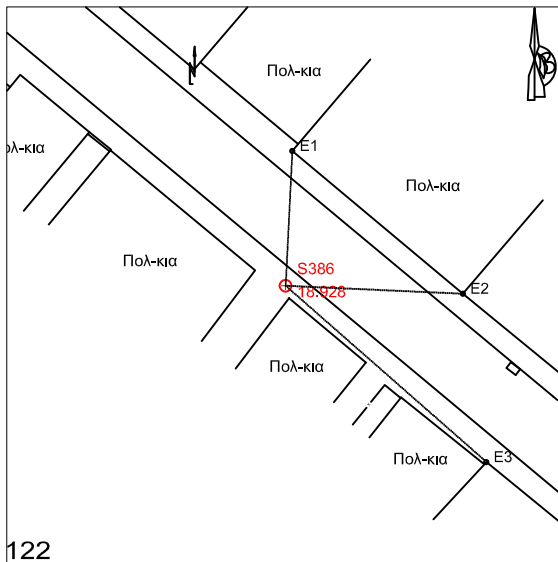

S387
X= 409155.428
Y=4500611.828
H= 20.245
E1= 14.51
E2= 8.5
E3= 10.65

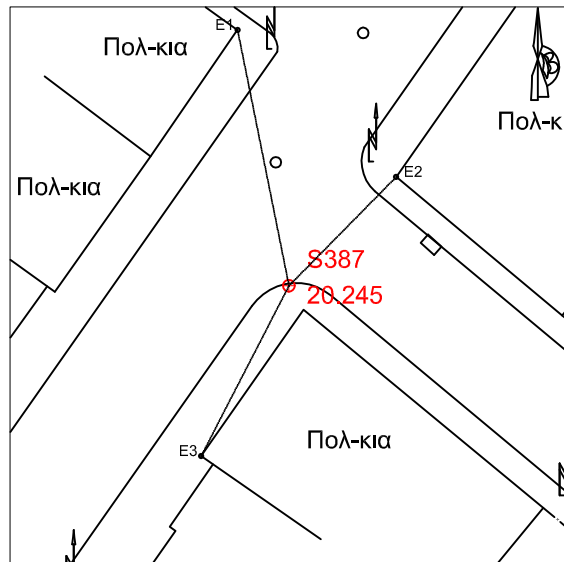

S388
X= 409188.239
Y=4500511.013
H= 19.013
E1= 10.52
E2= 9.28
E3= 8.16

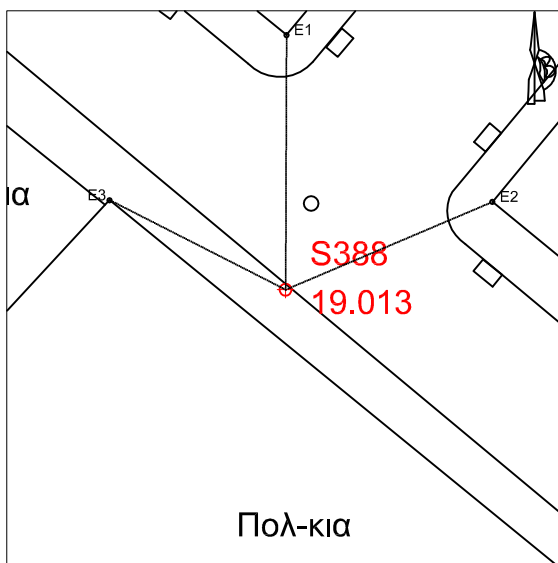

S389
X= 409232.119
Y=4500558.238
H= 20.426
E1= 8.26
E2= 13
E3= 10.15

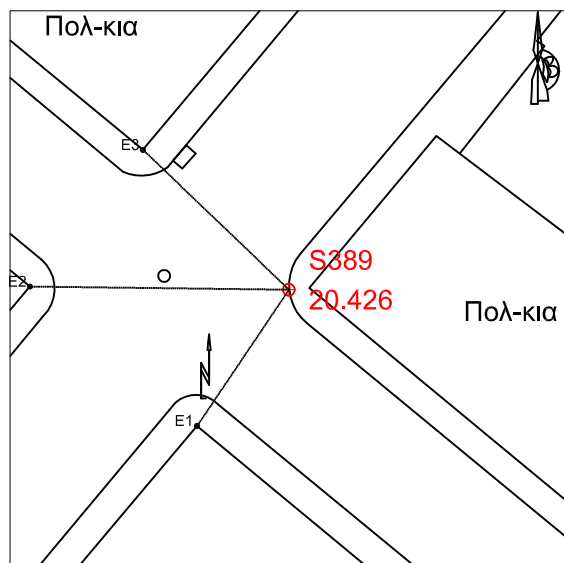

S390
 X= 409243.636
 Y=4500464.059
 H= 18.622
 E1= 16.83
 E2= 10.38
 E3= 12.66

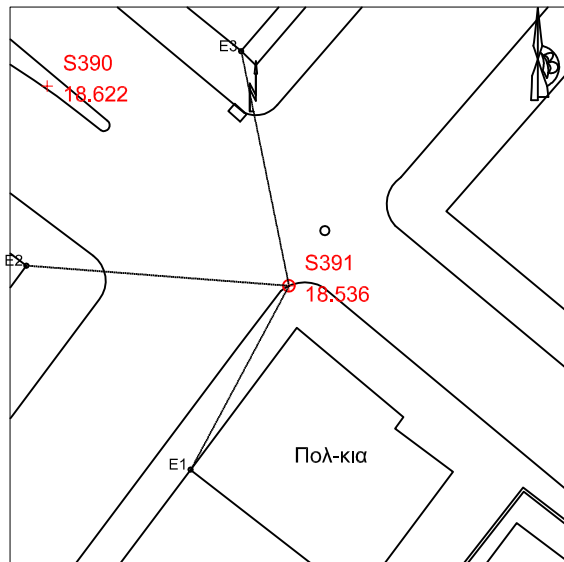
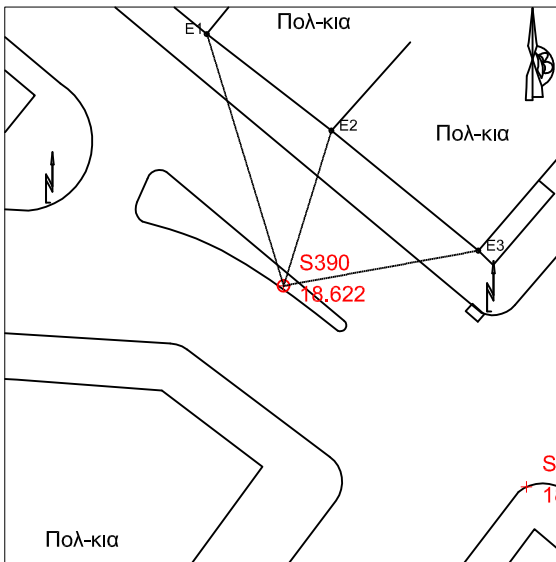

S391
 X= 409259.165
 Y= 4500451.21
 H= 18.536
 E1= 13.41
 E2= 16.94
 E3= 15.41

S392
 X= 409151.715
 Y=4500465.105
 H= 17.629
 E1= 15.18
 E2= 9.66
 E3= 7.51

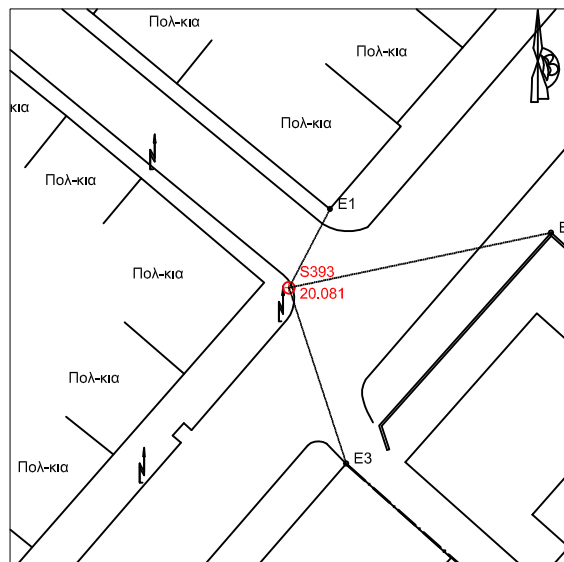
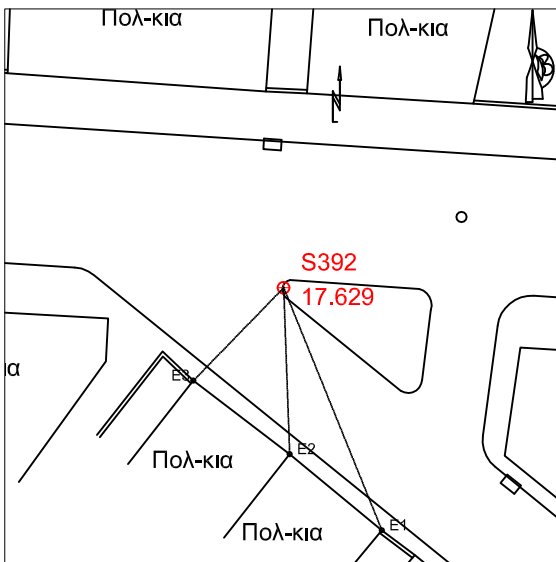

S393
 X= 409289.473
 Y=4500501.535
 H= 20.081
 E1= 8.22
 E2= 24.79
 E3= 17.11

S394
 X= 409300.314
 Y=4500417.455
 H= 18.299
 E1= 2.71
 E2= 9.56
 E3= 15.98

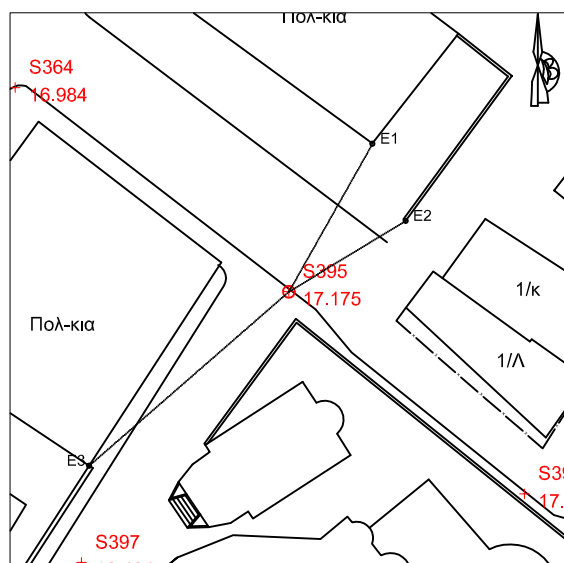
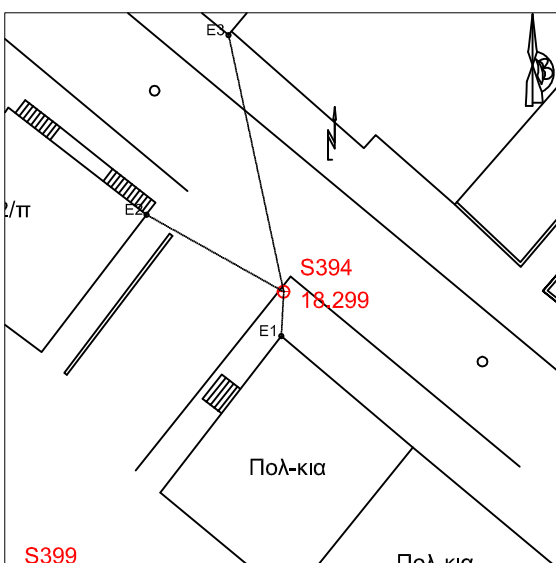

S395
 X= 409243.683
 Y=4500389.566
 H= 17.175
 E1= 12.25
 E2= 9.84
 E3= 19.09

S396
X= 409260.646
Y=4500375.005
H= 17.437
E1= 4.35
E2= 10.45
E3= 15.5

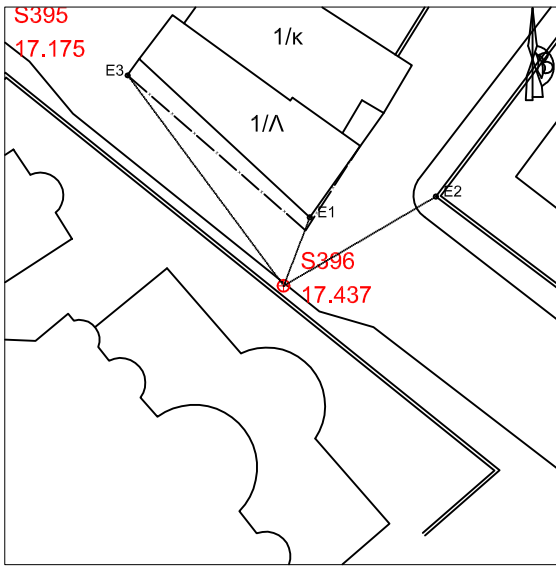

S397
X= 409228.745
Y=4500370.057
H= 16.404
E1= 6.99
E2= 4.85
E3= 15.28

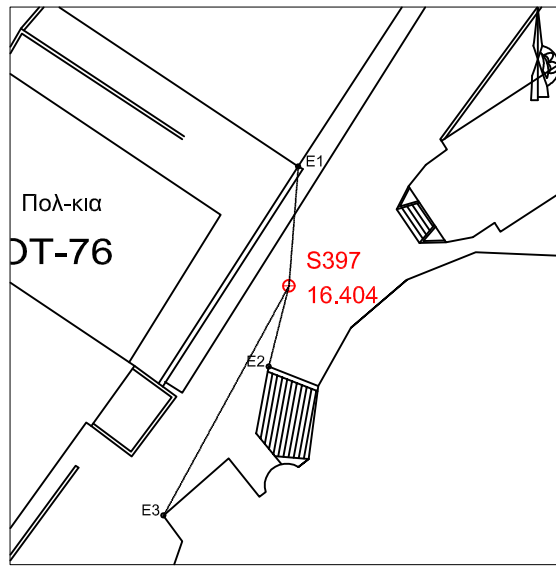

S398
X= 409285.971
Y= 4500366.12
H= 17.207
E1= 12.7
E2= 21.6
E3= 4.43

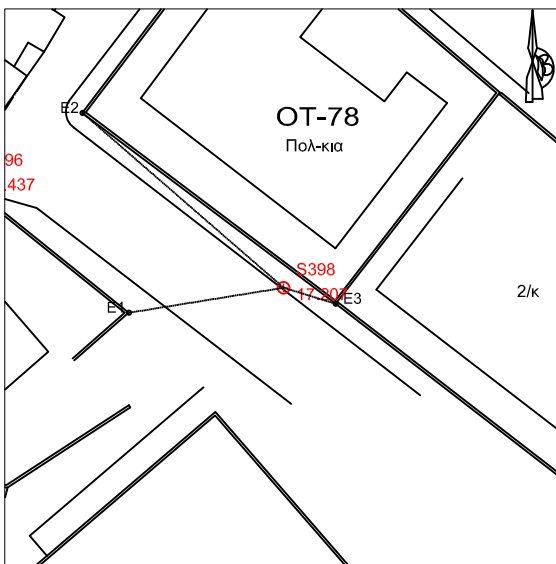

S399
X= 409283.524
Y=4500399.897
H= 17.504
E1= 9.09
E2= 15.46
E3= 10.7

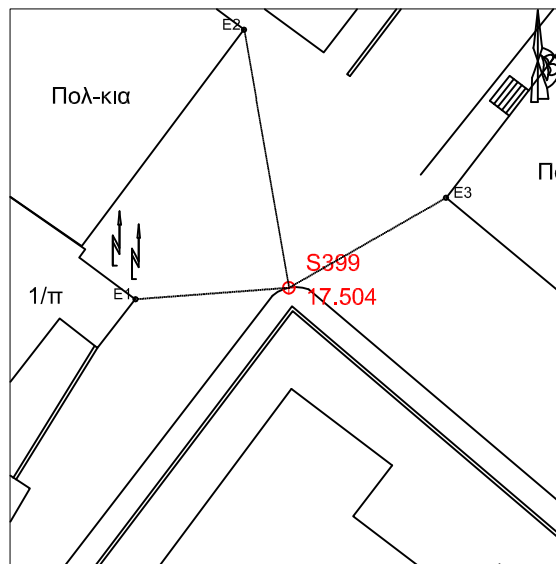

S400
X= 409323.049
Y= 4500426.01
H= 18.520
E1= 10.89
E2= 3.54
E3= 11.12

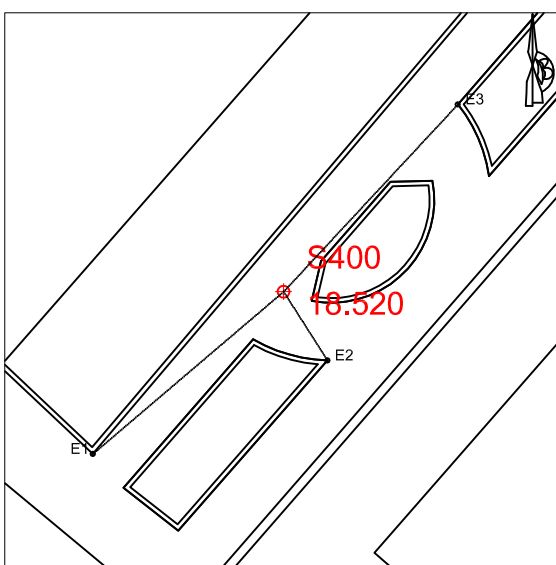

S401
X= 409362.045
Y=4500470.718
H= 19.807
E1= 6.12
E2= 11.39
E3= 4.57

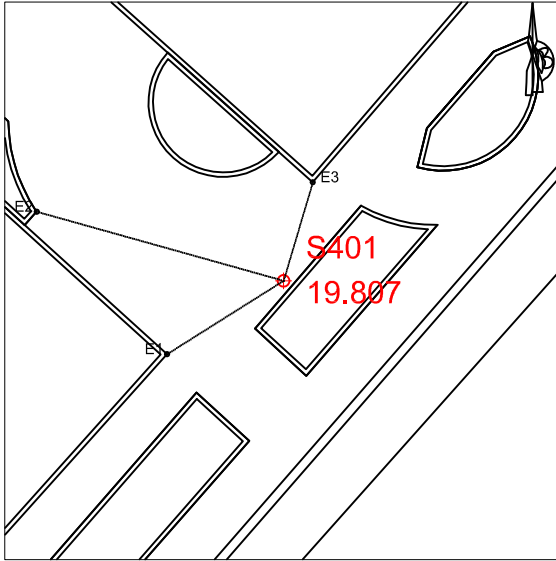

S402
X= 409398.772
Y=4500514.551
H= 22.149
E1= 8.69
E2= 19.75
E3= 9.9

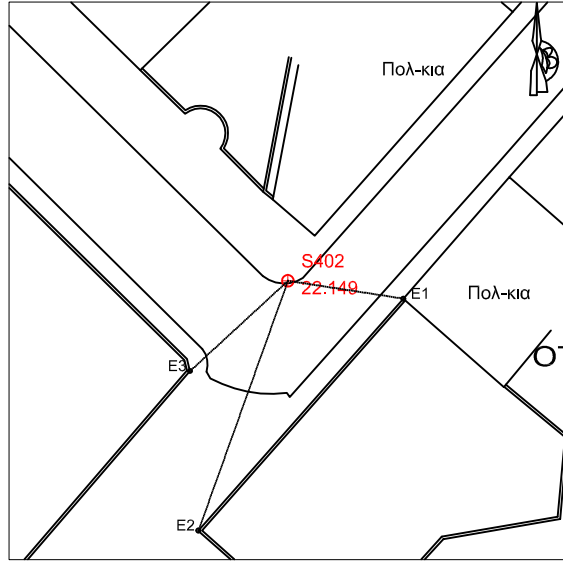

S403
X= 409436.332
Y=4500547.357
H= 23.918
E1= 19.67
E2= 14.65
E3= 19.23

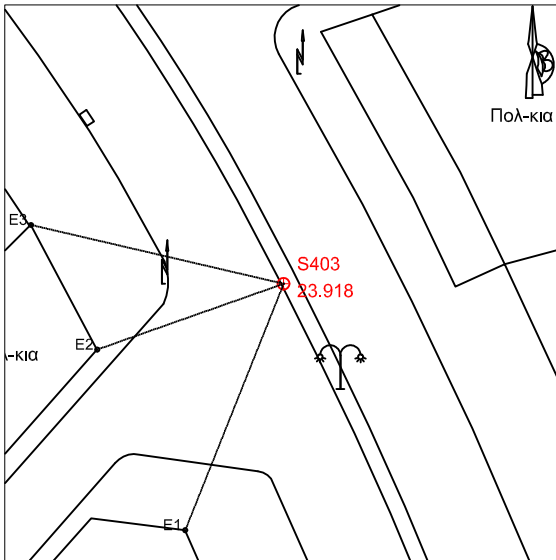

S404
X= 409357.784
Y=4500558.432
H= 22.730
E1= 11.98
E2= 25.27
E3= 16.22

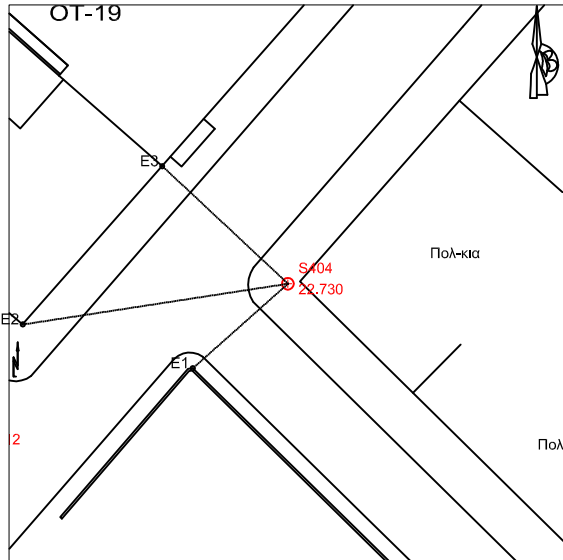

S405
X= 409391.359
Y=4500620.085
H= 23.877
E1= 13
E2= 22.74
E3= 7.29

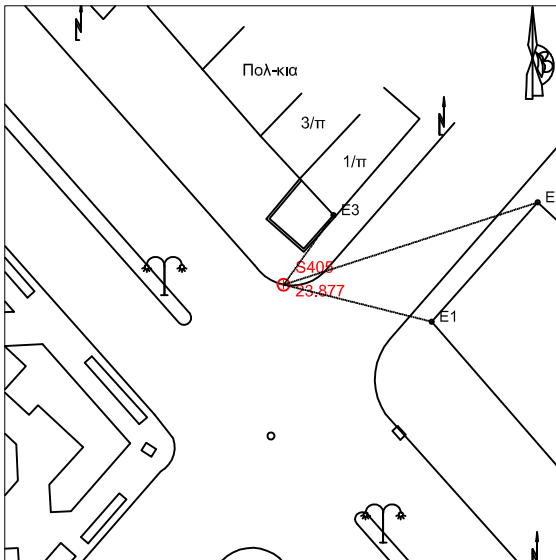

S406
X= 409327.364
Y=4500544.286
H= 21.712
E1= 11.65
E2= 21.88
E3= 15.68

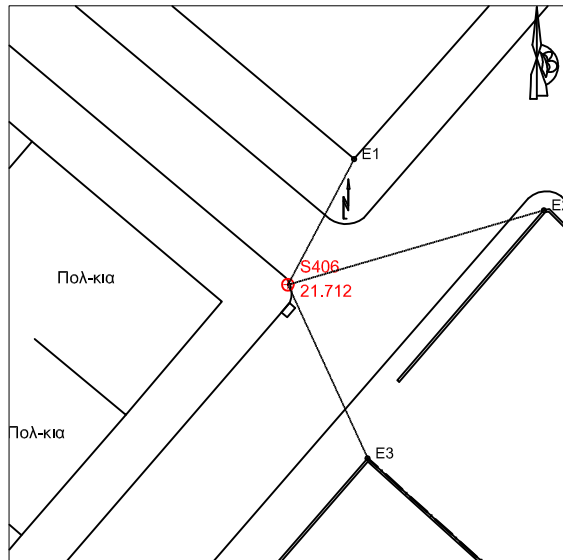

S407
X= 409294.218
Y=4500569.856
H= 21.858
E1= 18.42
E2= 5.51
E3= 13.41

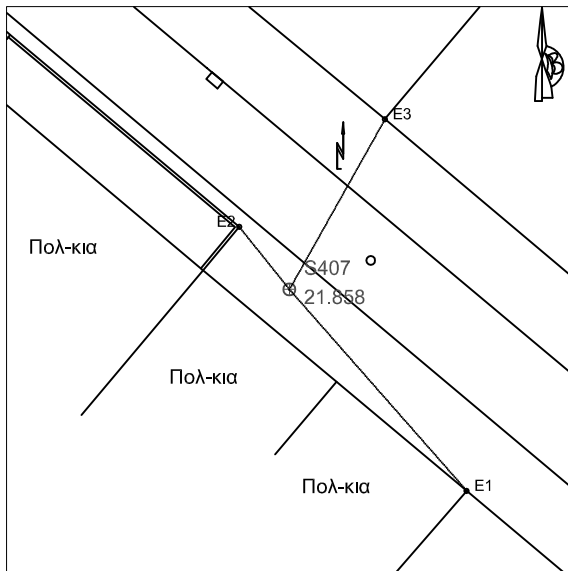

S408
X= 409263.477
Y=4500606.285
H= 21.839
E1= 10.38
E2= 7.84
E3= 16.58

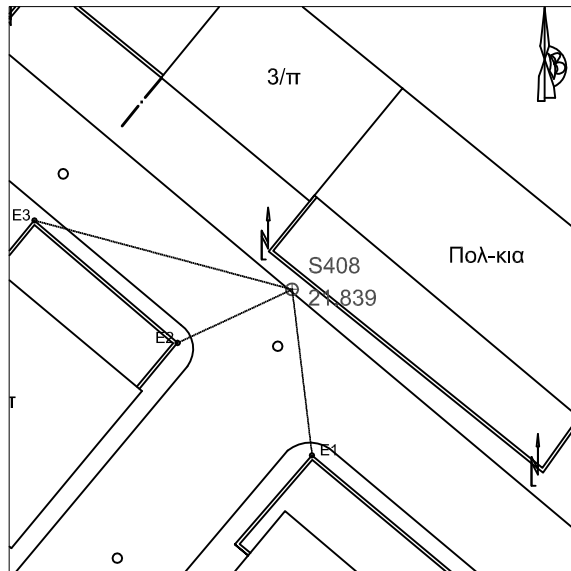

S409
X= 409157.541
Y=4500632.494
H= 20.779
E1= 12.72
E2= 15.11
E3= 8.14

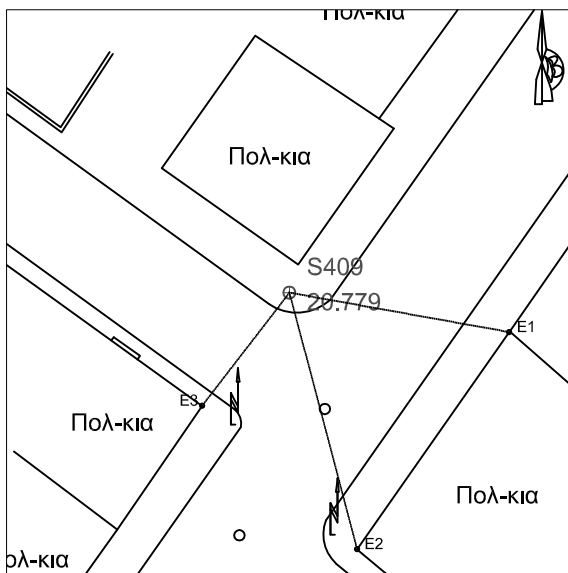

S410
X= 409181.944
Y=4500665.571
H= 21.723
E1= 15.34
E2= 12.19
E3= 9.27

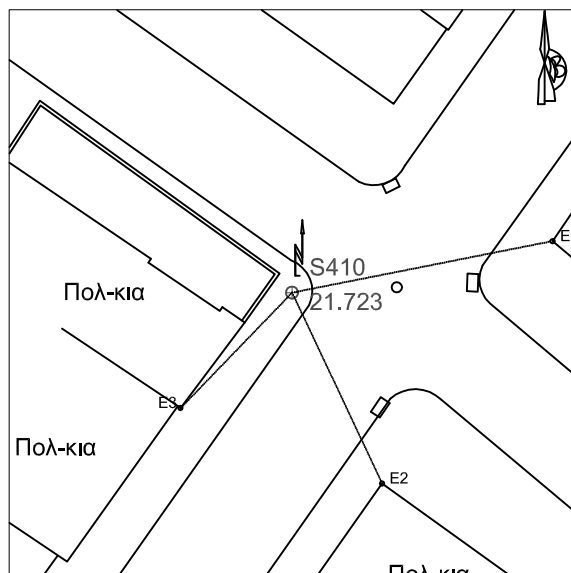

S411
X= 409119.141
Y=4500716.867
H= 21.602
E1= 11.9
E2= 14.31
E3= 9.01

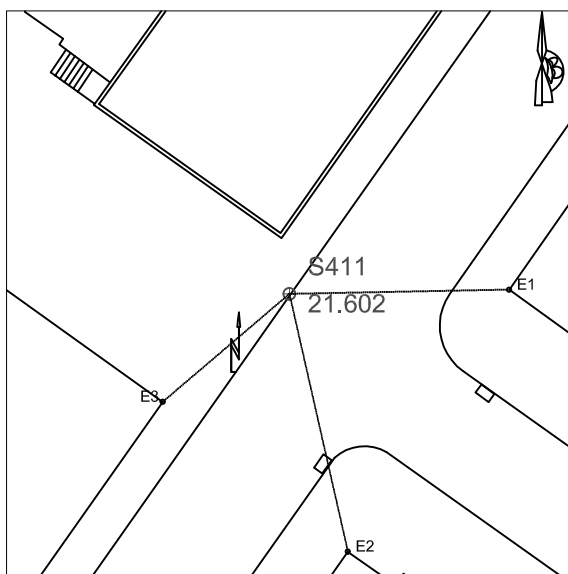

S412
X= 409047.45
Y=4500710.956
H= 20.112
E1= 7.76
E2= 15.23
E3= 15.48

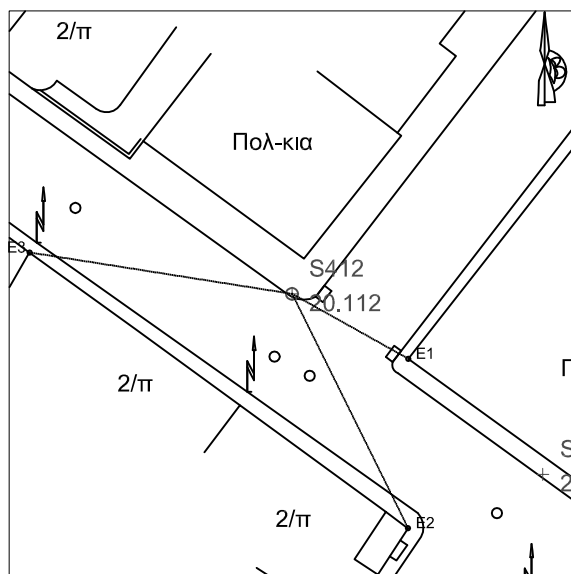

S413
X= 409006.868
Y=4500731.345
H= 19.747
E1= 7.92
E2= 10.95
E3= 10.88

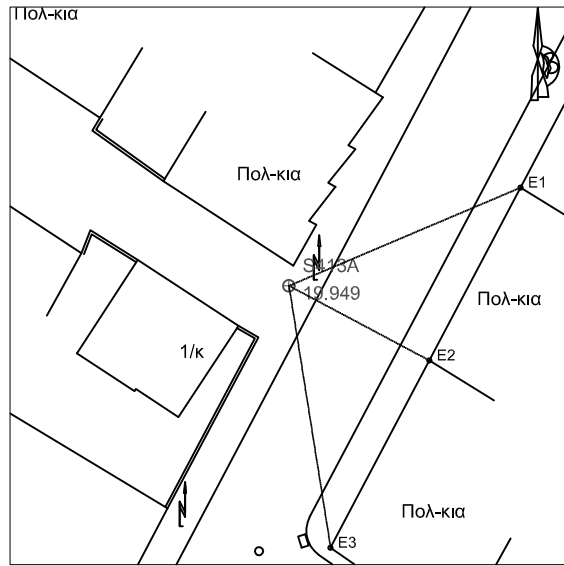
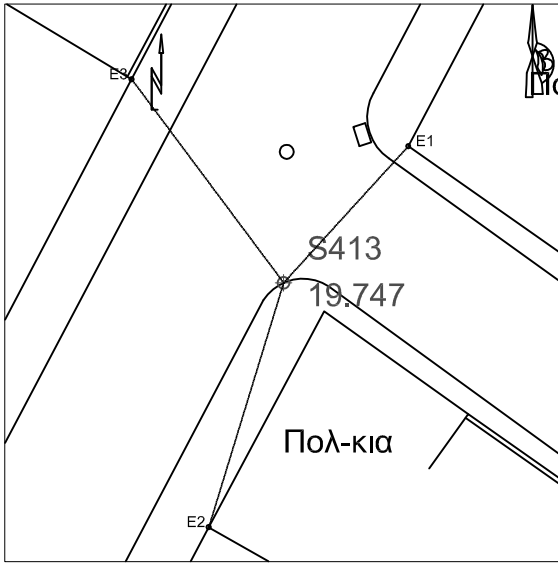

S413A
X= 409009.178
Y=4500756.258
H= 19.949
E1= 18.32
E2= 11.58
E3= 19.3

S414
X= 409075.514
Y=4500745.918
H= 20.993
E1= 13.4
E2= 8.33
E3= 9.85

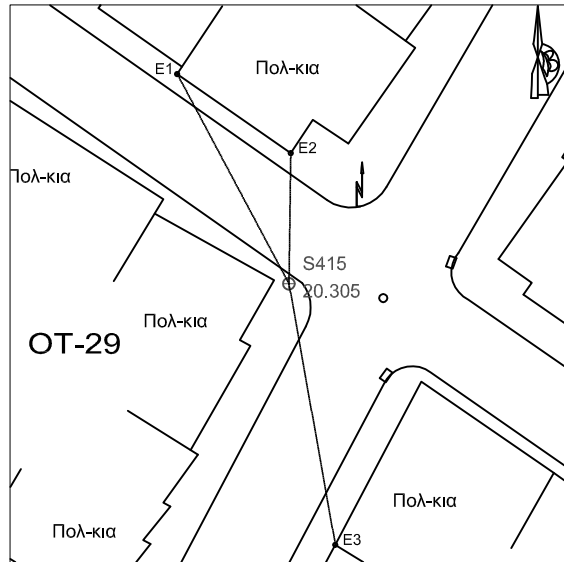
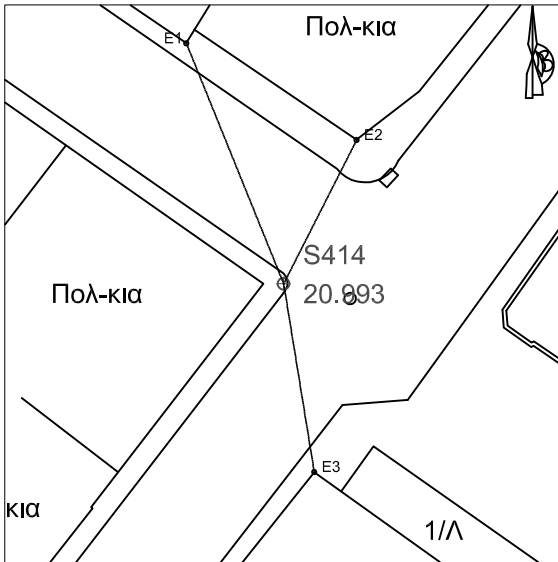

S415
X= 409022.665
Y=4500782.458
H= 20.305
E1= 17.34
E2= 9.53
E3= 19.35

S416
X= 409119.641
Y=4500789.375
H= 21.806
E1= 12.27
E2= 8.95
E3= 13.59

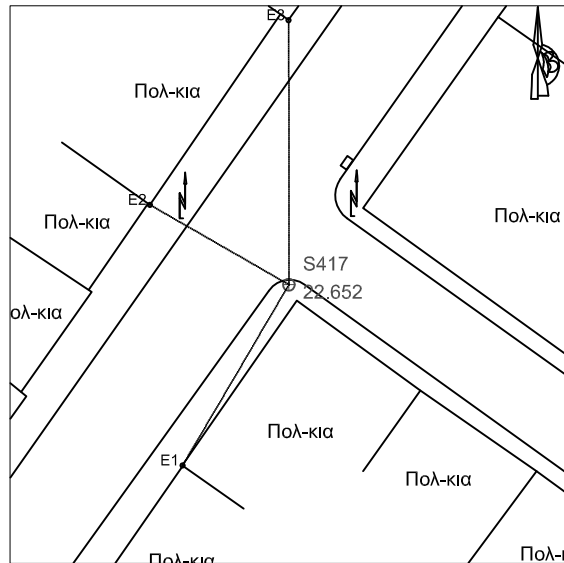
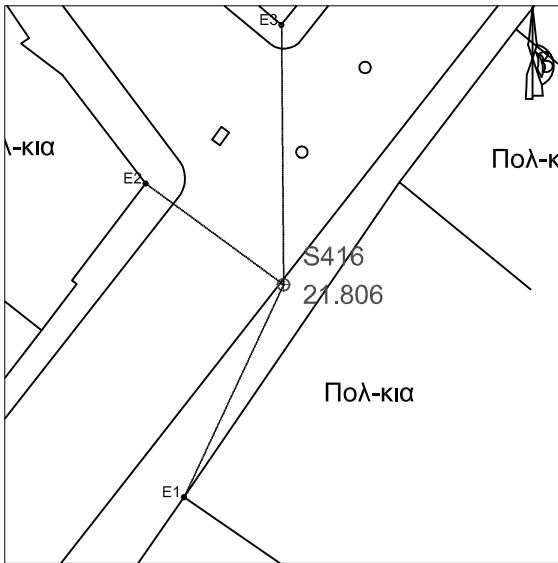

S417
X= 409215.478
Y=4500697.026
H= 22.652
E1= 14.78
E2= 11.29
E3= 18.65

S418
X= 409152.626
Y=4500699.857
H= 21.848
E1= 11.01
E2= 11.81
E3= 6.31

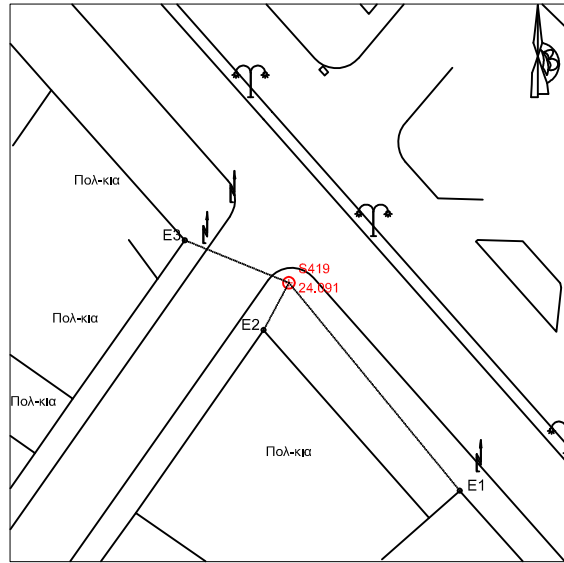
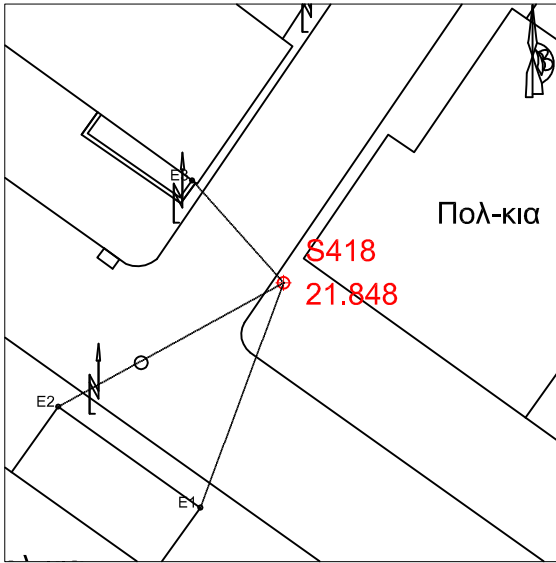

S419
X= 409252.958
Y=4500749.305
H= 24.091
E1= 27.72
E2= 5.52
E3= 11.59

S420
X= 409259.949
Y=4500673.411
H= 23.231
E1= 7.72
E2= 10.41
E3= 11.85

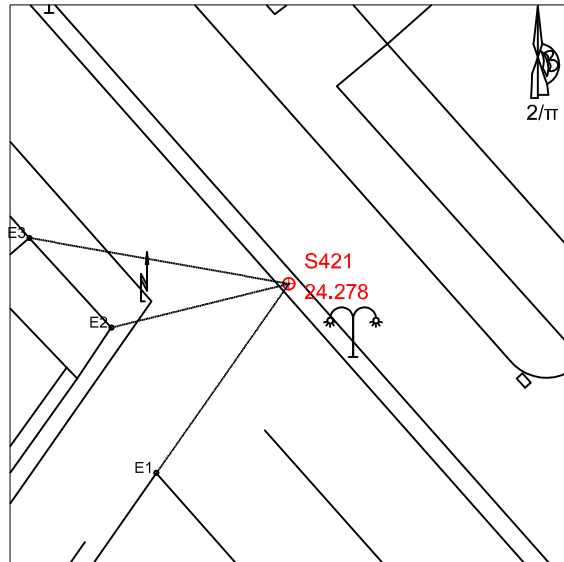
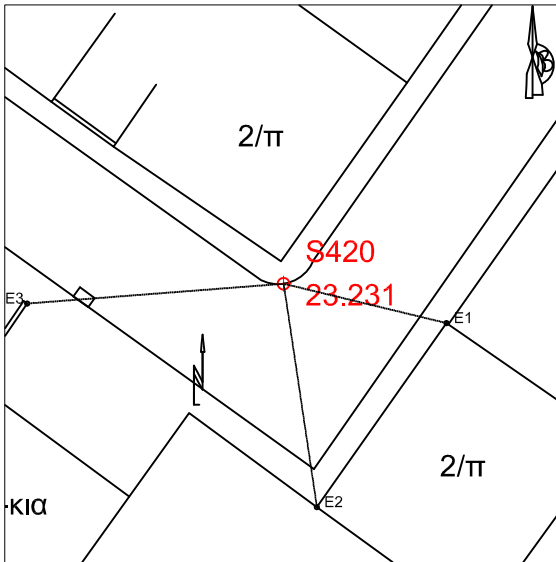

S421
X= 409297.183
Y=4500714.071
H= 24.278
E1= 15.11
E2= 11.96
E3= 17.24

S422
X= 409184.272
Y=4500756.119
H= 22.986
E1= 5.58
E2= 9.99
E3= 27.48

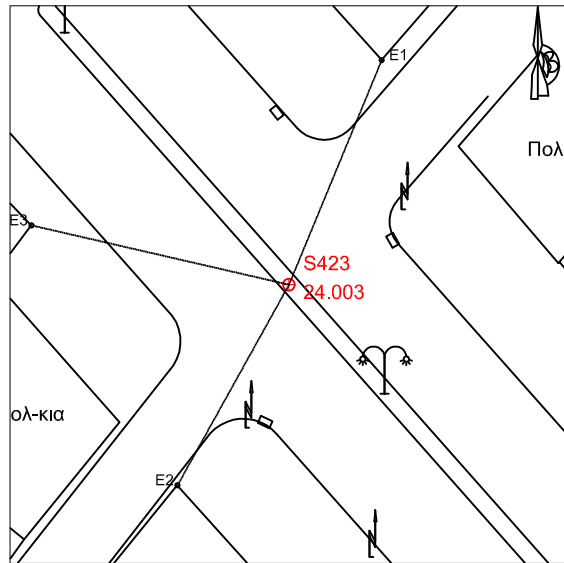
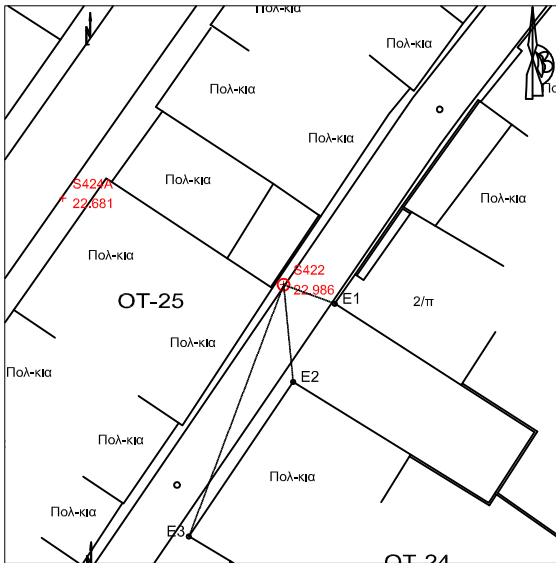

S423
X= 409220.817
Y=4500800.305
H= 24.003
E1= 16.74
E2= 15.81
E3= 18.2

S424
X= 408952.182
Y=4500764.009
H= 19.194
E1= 13.72
E2= 10.5
E3= 18.56

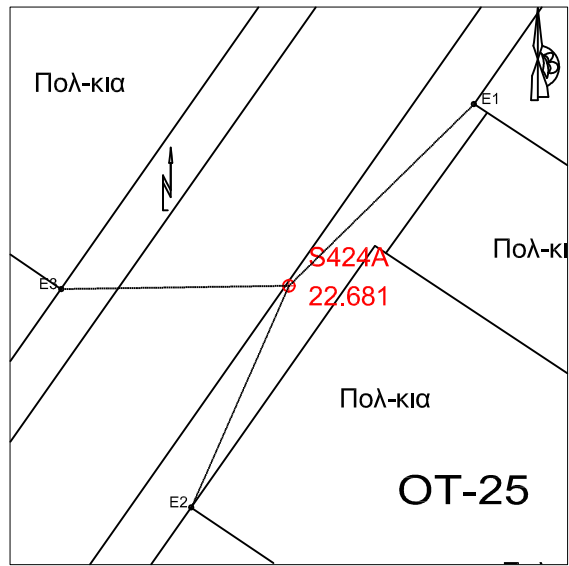
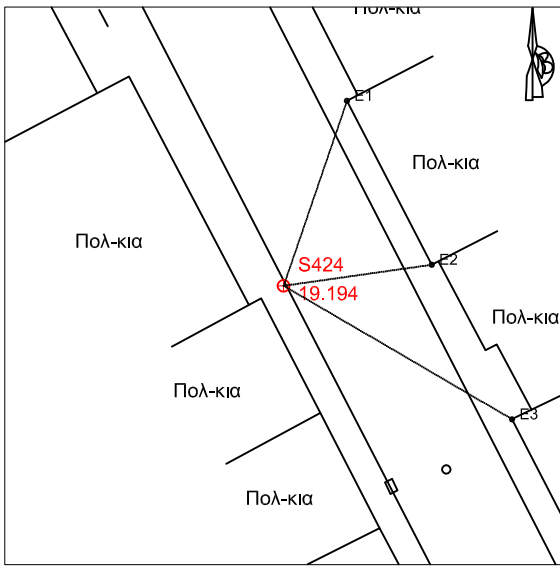

S424A
X= 409161.73
Y=4500764.934
H= 22.681
E1= 13.33
E2= 12.45
E3= 11.71

S425
X= 409048.496
Y=4500822.341
H= 20.741
E1= 15.35
E2= 7.25
E3= 14.49

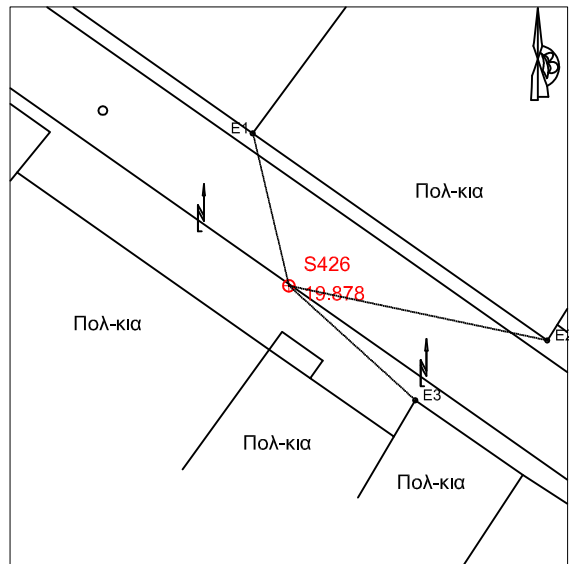
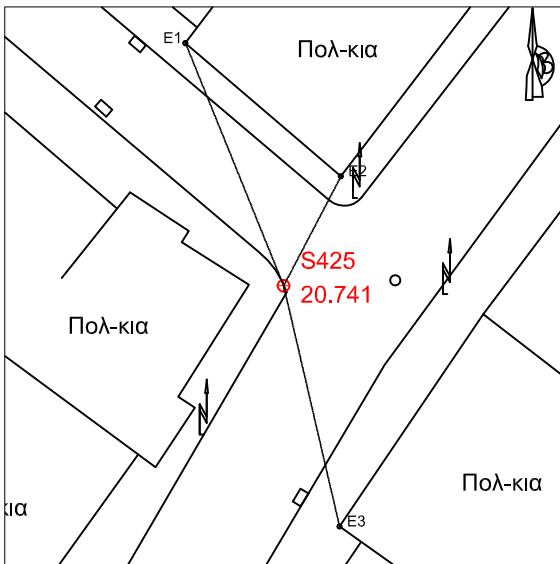

S426
X= 408984.161
Y=4500810.134
H= 19.878
E1= 10.71
E2= 18.06
E3= 11.66

S427
X= 408988.165
Y=4500880.964
H= 20.666
E1= 14.49
E2= 8.8
E3= 14.27

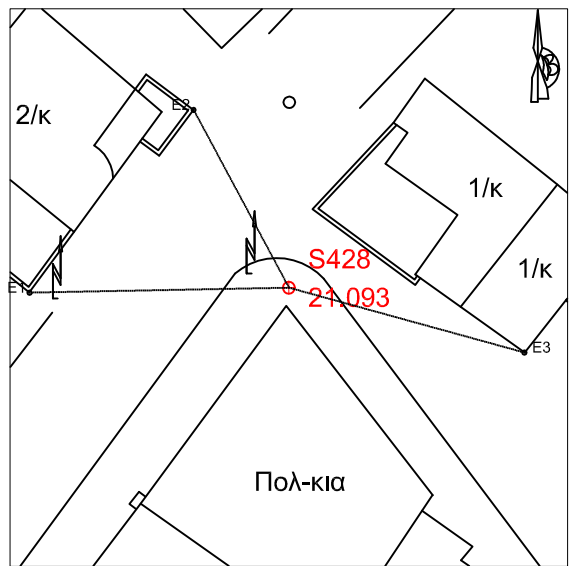
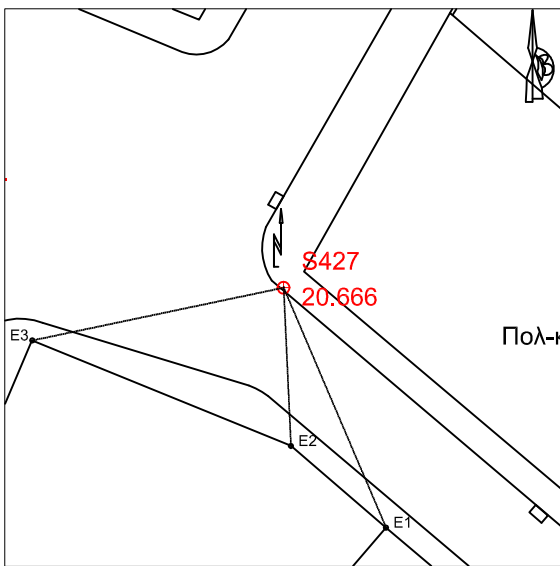

S428
X= 409076.438
Y=4500843.203
H= 21.093
E1= 13.42
E2= 10.43
E3= 12.64

S429
X= 409087.365
Y=4500869.078
H= 21.510
E1= 7.31
E2= 9.15
E3= 15.57

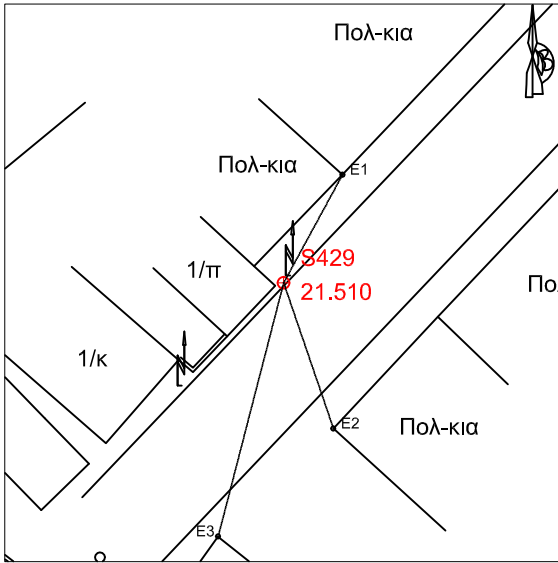

S430
X= 409092.908
Y=4500822.443
H= 21.482
E1= 17.92
E2= 18.32
E3= 17.8

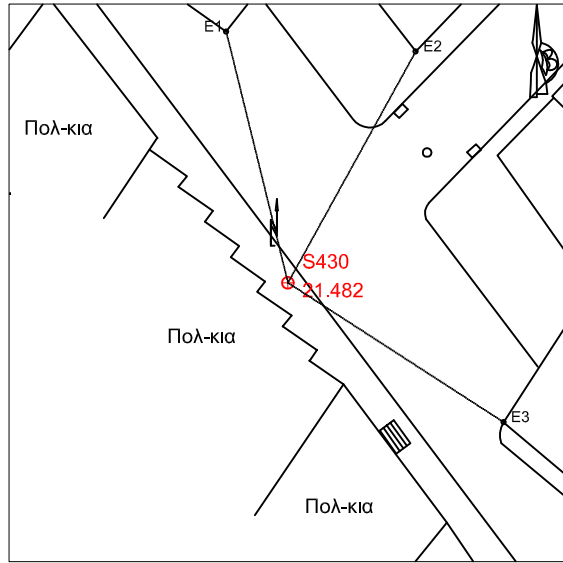

S431
X= 409156.142
Y=4500886.395
H= 23.154
E1= 10.8
E2= 20.8
E3= 14.97

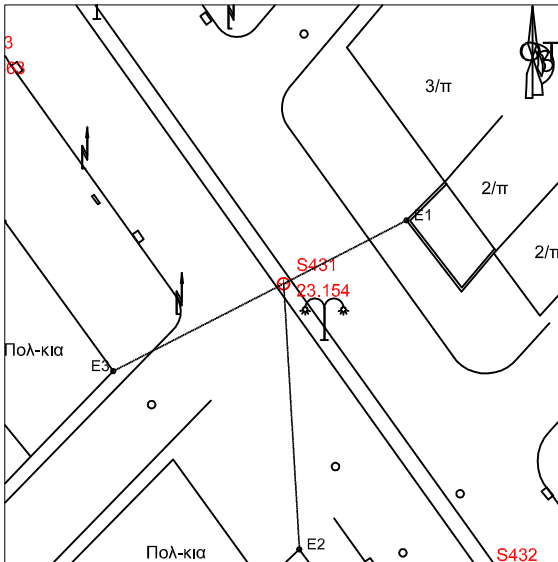

S432
X= 409171.782
Y=4500863.724
H= 23.356
E1= 12.34
E2= 14.28
E3= 14.53

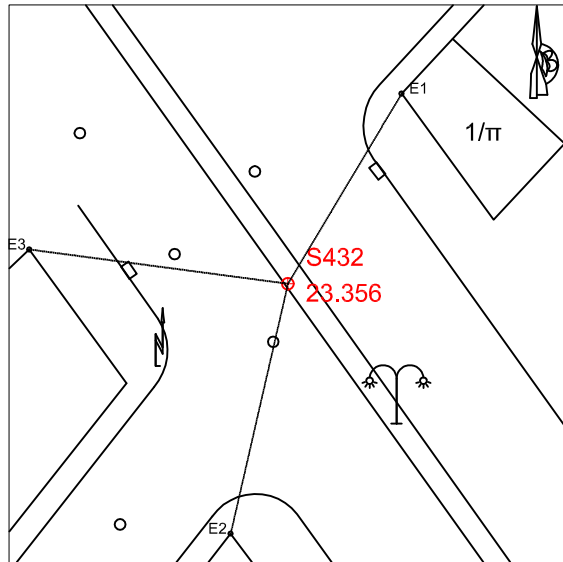

S433
X= 409130.765
Y=4500903.769
H= 22.663
E1= 13.01
E2= 4.62
E3= 10.11

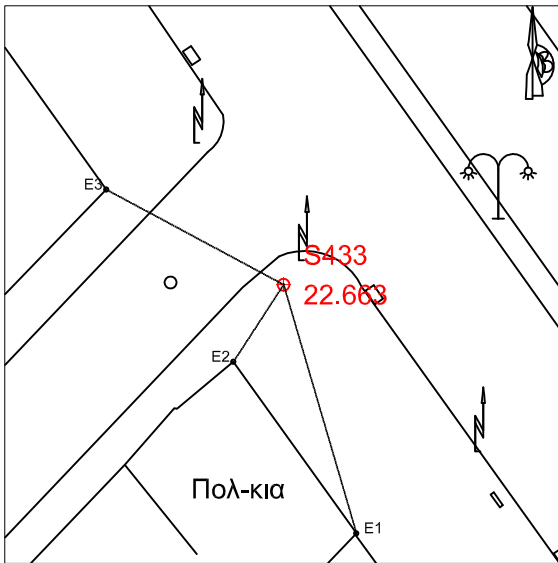

S434
X= 408930.408
Y=4500799.334
H= 19.317
E1= 4.64
E2= 22.66
E3= 13.44

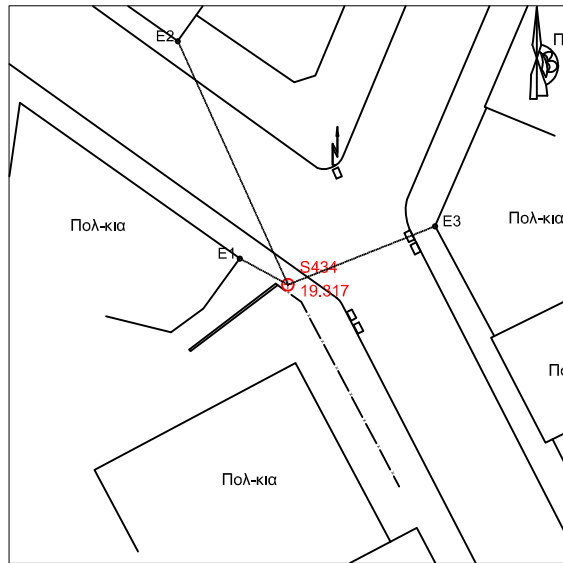

S435
X= 408947.336
Y=4500840.659
H= 19.727
E1= 10.64
E2= 9.77
E3= 12.11

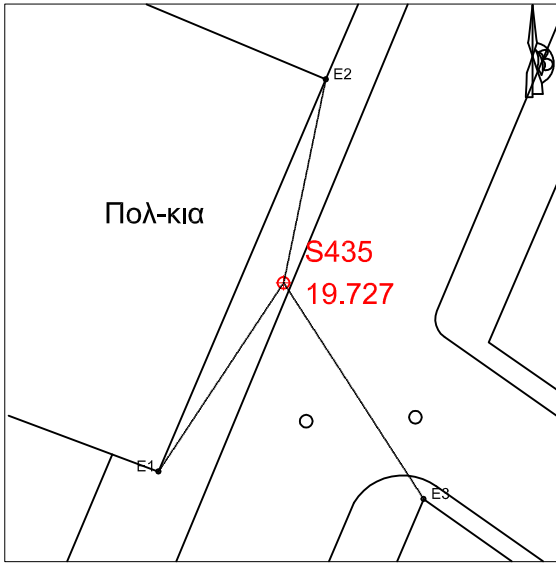

S436
X= 408967.564
Y=4500887.685
H= 20.424
E1= 11.71
E2= 6.77
E3= 14.67

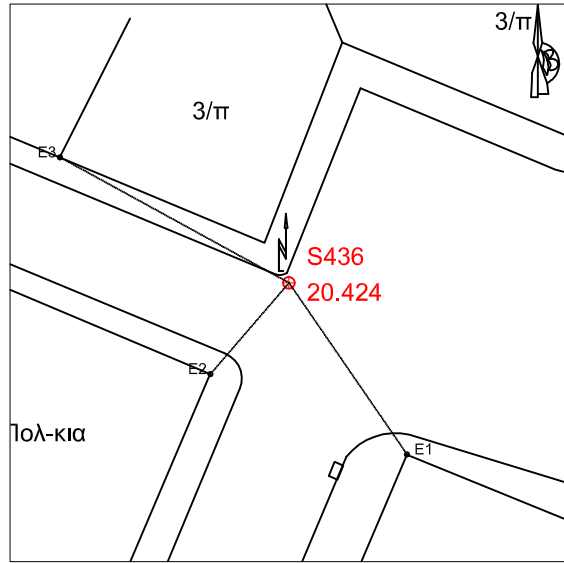

S437
X= 409006.319
Y=4500914.262
H= 21.002
E1= 16.77
E2= 12.34
E3= 16.14

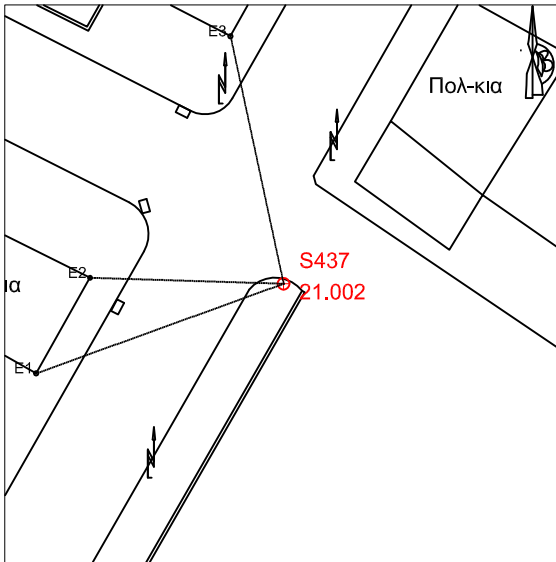

S438
X= 409032.617
Y=4500963.604
H= 21.423
E1= 10.93
E2= 10.21
E3= 18.46

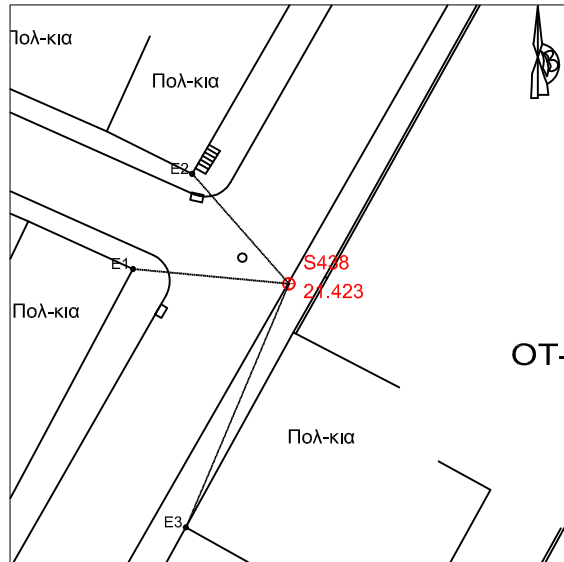

S439
X= 409031.455
Y=4500902.476
H= 21.361
E1= 20.16
E2= 10.61
E3= 22.29

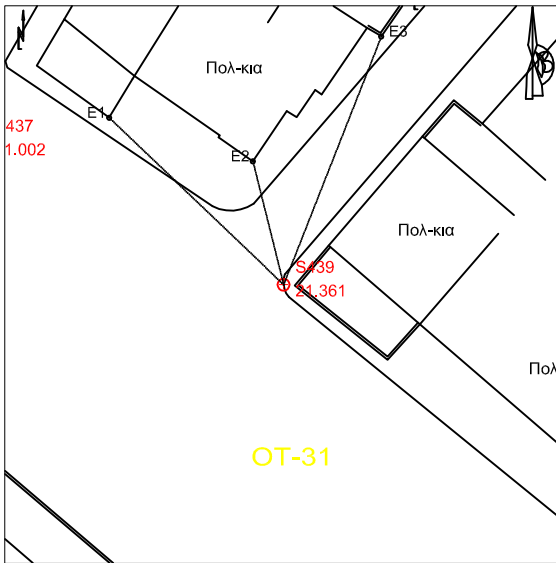

S440
X= 409054.562
Y=4500929.804
H= 21.756
E1= 16.32
E2= 10.48
E3= 13.79

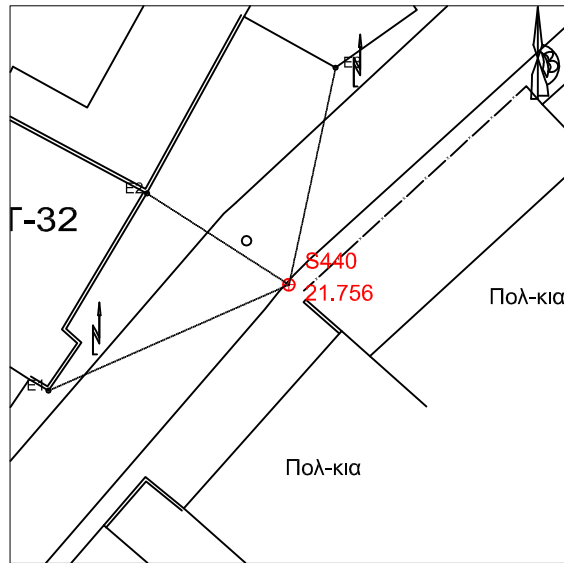

S441
X= 409041.053
Y=4500867.255
H= 21.008
E1= 25.5
E2= 6.35
E3= 15.46

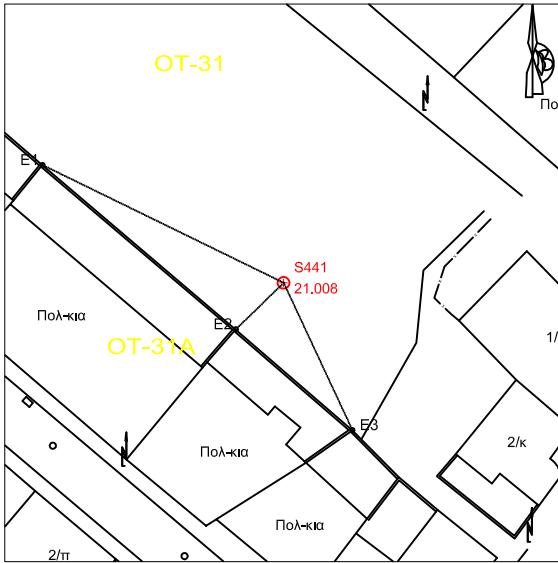

S442
X= 409097.176
Y=4500968.428
H= 23.076
E1= 20.91
E2= 15.72
E3= 18.73

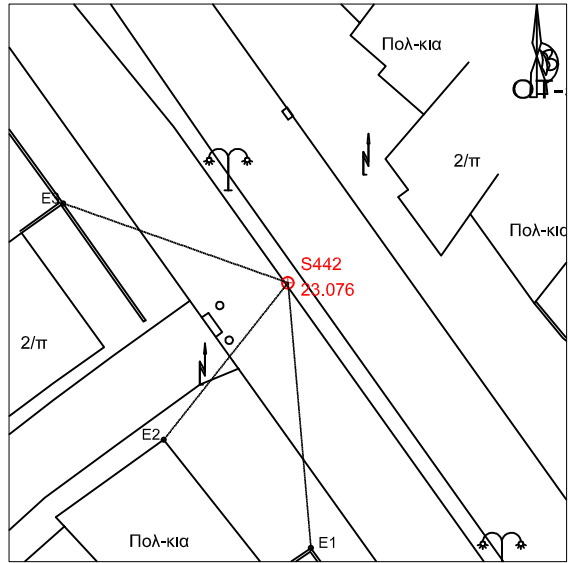

S443
X= 409049.77
Y=4500991.296
H= 22.345
E1= 17.8
E2= 11.17
E3= 16.57

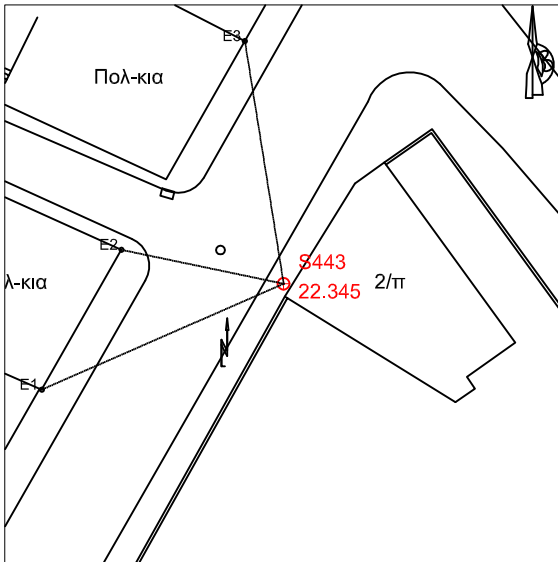

S444
X= 409008.854
Y=4501008.113
H= 22.527
E1= 20.83
E2= 13.04
E3= 19.11

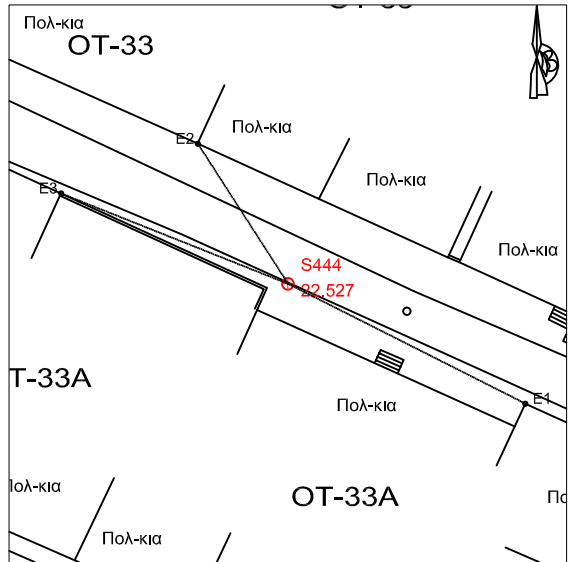

S445
X= 409114.779
Y=4500943.722
H= 23.039
E1= 17.02
E2= 11.2
E3= 16.27

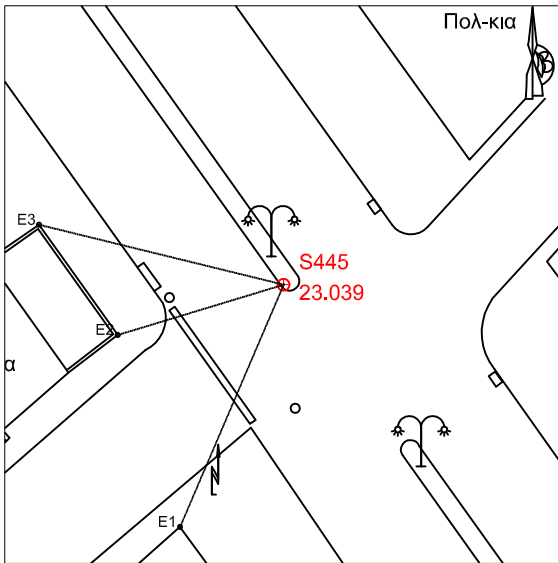

S446
X= 409191.823
Y= 4500820.26
H= 23.387
E1= 9.58
E2= 10.74
E3= 4.29

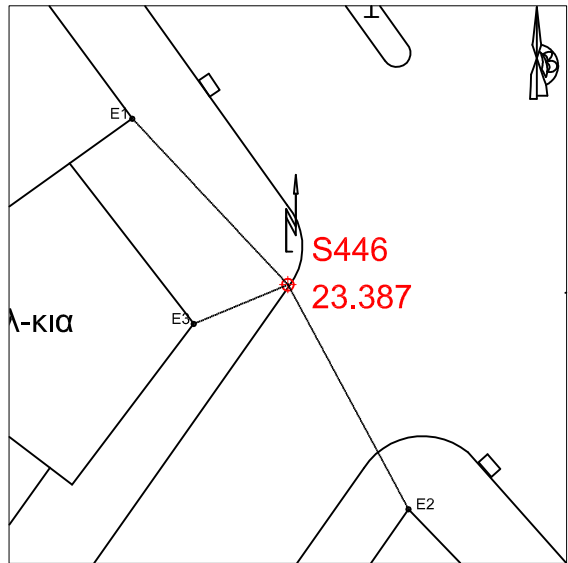

S447
X= 409344.314
Y=4500648.123
H= 23.841
E1= 7.01
E2= 6.21
E3= 17.49

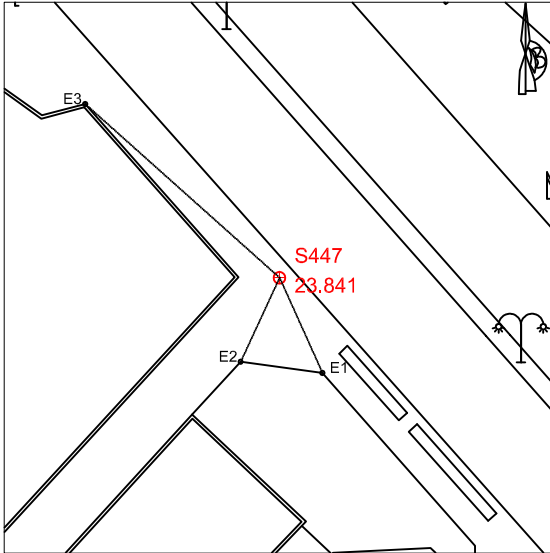

S447A
X= 409321.781
Y=4500624.929
H= 23.649
E1= 7.09
E2= 21.79
E3= 13.6

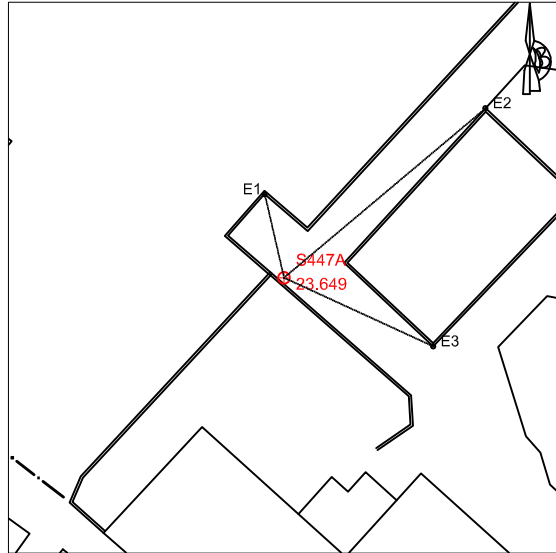

S448
X= 409357.757
Y=4500614.035
H= 23.673
E1= 10.2
E2= 16.85
E3= 8.64

