

ΤΕΥΧΟΣ ΕΞΑΣΦΑΛΙΣΕΩΝ ΣΤΑΣΕΩΝ



ΤΙΤΛΟΣ ΜΕΛΕΤΗΣ :

« ΥΨΟΜΕΤΡΙΚΗ ΜΕΛΕΤΗ ΟΔΩΝ ΤΩΝ Π.Ε 06
(ΣΚΕΠΑΡΝΗ) & Π.Ε. 07 (Ζ. ΠΗΓΗΣ) ΤΗΣ ΔΗΜΟΤΙΚΗΣ
ΚΟΙΝΟΤΗΤΑΣ ΑΜΠΕΛΟΚΗΠΩΝ ΤΟΥ
ΔΗΜΟΥ ΑΜΠΕΛΟΚΗΠΩΝ ΜΕΝΕΜΕΝΗΣ »

Σ Π Υ Ρ Ι Δ Ο Π Ο Υ Λ Ο Σ Β . Γ Ρ Η Γ Ο Ρ Ι Ο Σ

Τ η λ . Γ ρ α φ ε ί ο υ : 2310725900

Κ ι ν . 6936865624

F a x : 2310 725900

Η μ ε ρ ο μ η ν ί α : 29/11/2013

S203
 X=408615.587
 Y=4500419.254
 H= 14.204
 E1= 9.48
 E2= 9.6
 2E3= 12.78

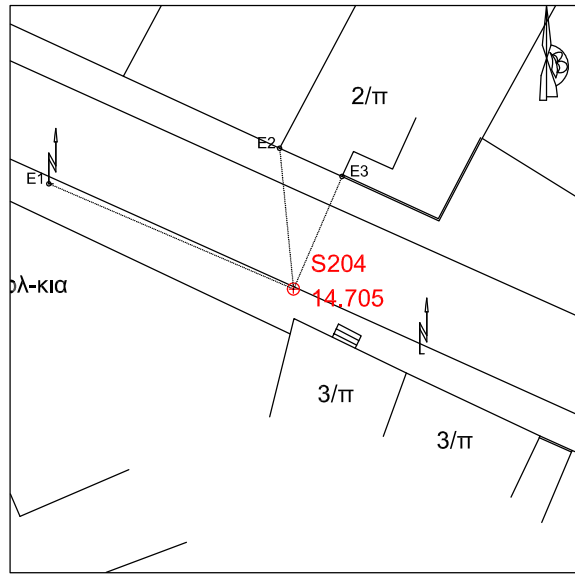
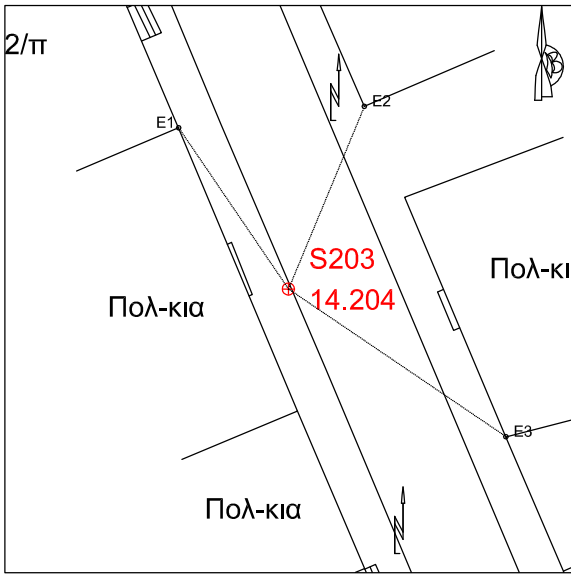

S204
 X= 408635.16
 Y=4500441.318
 H= 14.705
 E1= 15.4
 7E2= 8.21
 E3= 7.12

S205
 X=408627.314
 Y=4500391.565
 H= 14.091
 E1= 4.92
 E2= 8.52
 E3= 14.09

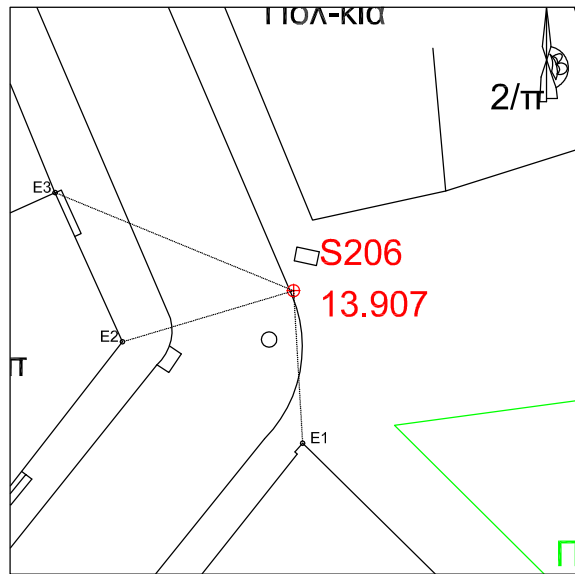

S206
 X= 408650.537
 Y=4500350.1
 H= 13.907
 E1= 5.94
 E2= 6.94
 E3= 10.02

S207
 X= 408598.874
 Y=4500379.993
 H= 13.627
 E1= 7.58
 E2= 9.11
 E3= 5.96

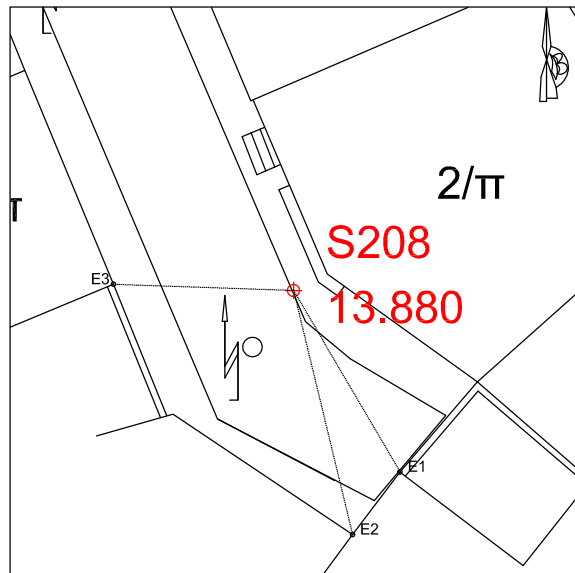
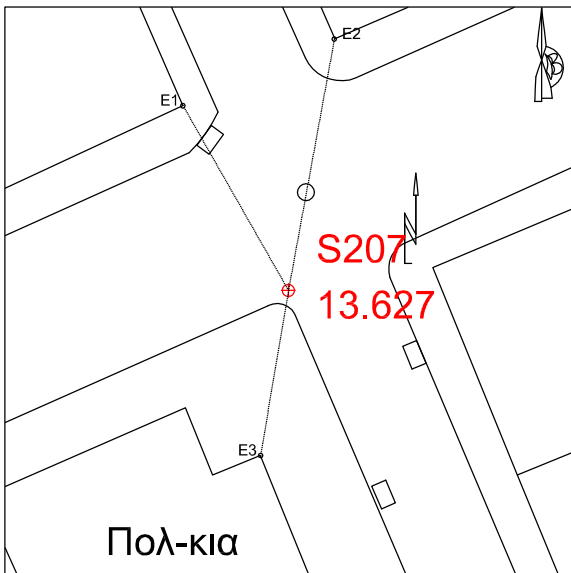

S208
 X= 408617.516
 Y=4500345.278
 H= 13.880
 E1= 6.48
 E2= 7.73
 E3= 5.55

S209
 X= 408613.543
 Y=4500308.439
 H= 13.296
 E1= 15.45
 E2= 8.58
 E3= 11.22

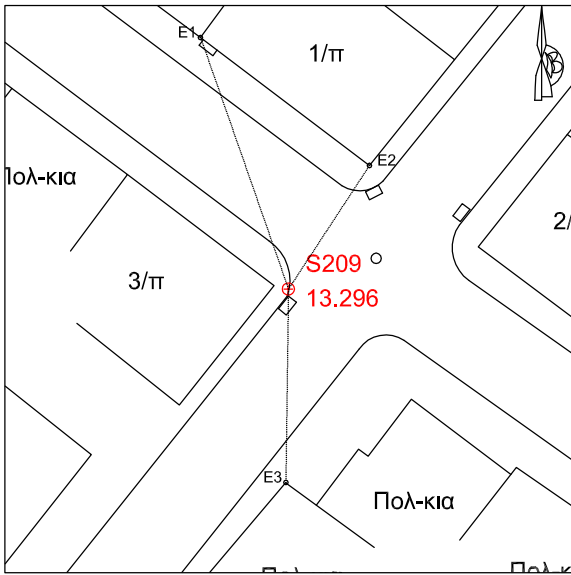

S210
 X= 408672.637
 Y=4500340.879
 H= 14.241
 E1= 10.31
 E2= 13.25
 E3= 14.77

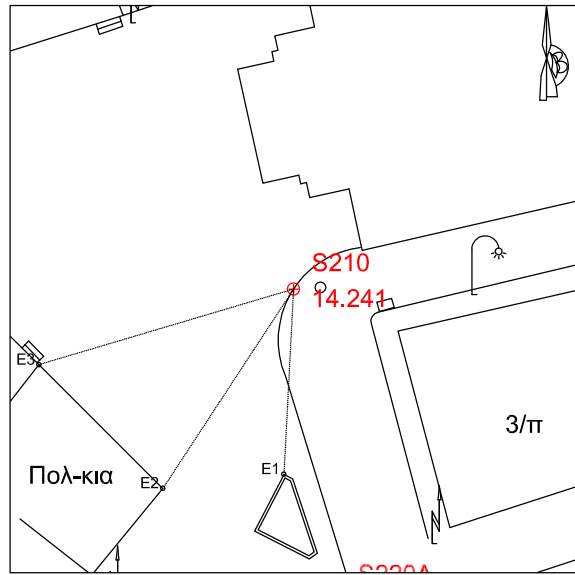

S211
 X= 408642.662
 Y=4500291.413
 H= 13.308
 E1= 11.46
 E2= 7.55
 E3= 8.1

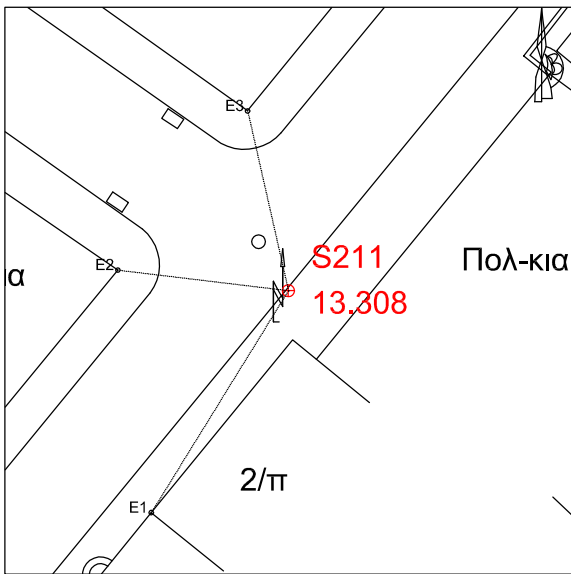

S212
 X= 408590.832
 Y=4500281.732
 H= 12.805
 E1= 7.36
 E2= 9.85
 E3= 5.13

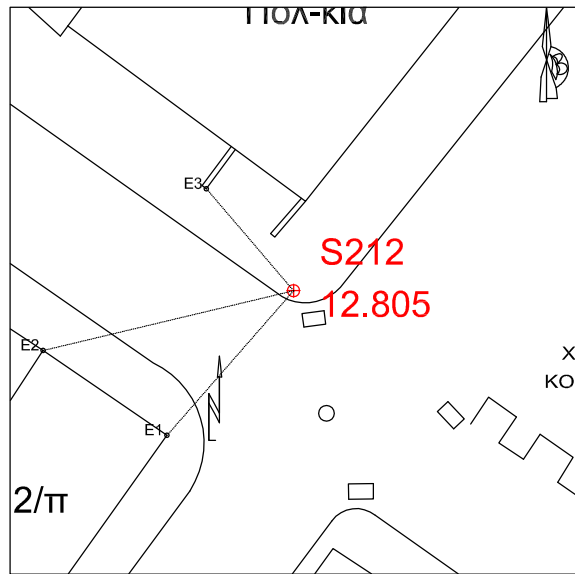

S213
 X= 408586.892
 Y=4500336.914
 H= 13.289
 E1= 9.03
 E2= 7.78
 E3= 12.37

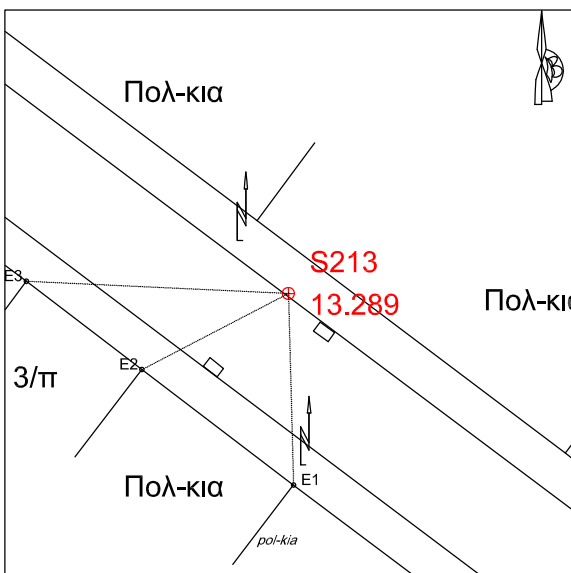

S214
 X= 408620.095
 Y=4500261.795
 H= 12.974
 E1= 8.14
 E2= 13.89
 E3= 9.35

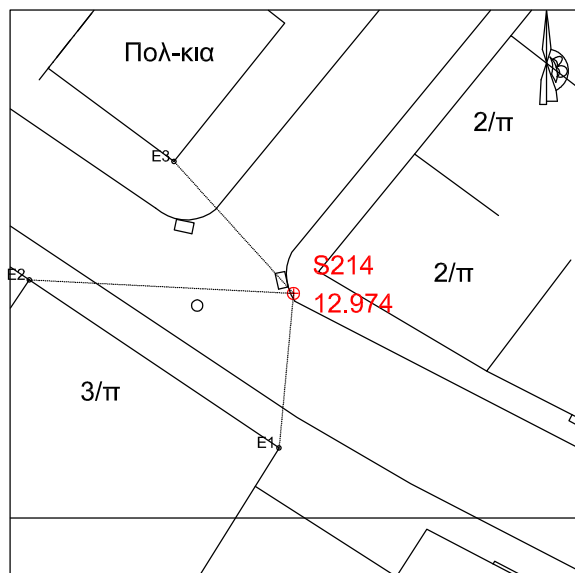

S215
 X= 408665.52
 Y=4500430.021
 H= 14.879
 E1= 3.59
 E2= 7.18
 E3= 8.65

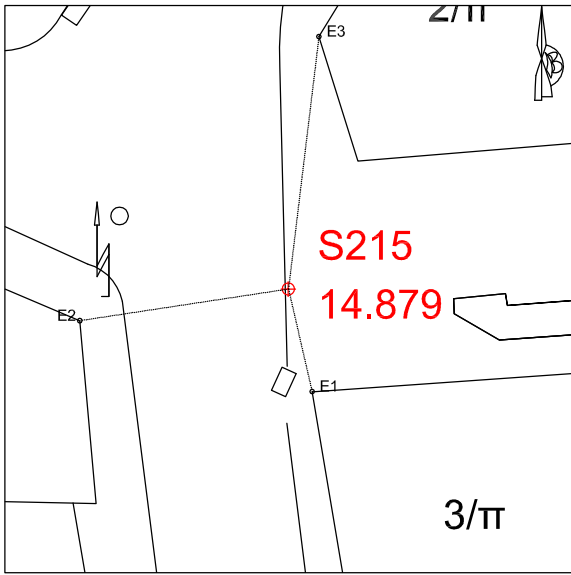

S216
 X= 408666.735
 Y=4500453.709
 H= 14.967
 E1= 14.97
 E2= 5.63
 E3= 15.1

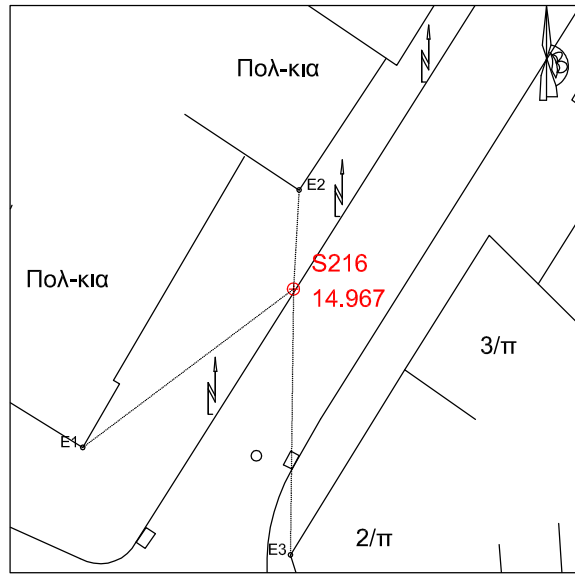

S217
 X= 408719.255
 Y=4500434.149
 H= 15.414
 E1= 16.75
 E2= 4.32
 E3= 13.42

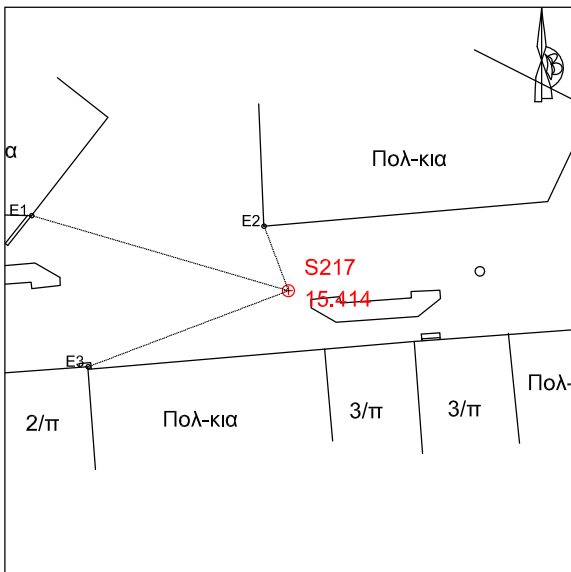

S218
 X= 408664.548
 Y=4500392.645
 H= 14.404
 E1= 13.38
 E2= 8.6
 E3= 13.57



S219
 X= 408713.148
 Y=4500394.039
 H= 14.722
 E1= 9.79
 E2= 7.49
 E3= 12.02



S220
 X= 408679.081
 Y=4500309
 H= 13.549
 E1= 8.97
 E2= 13.87
 E3= 12.89

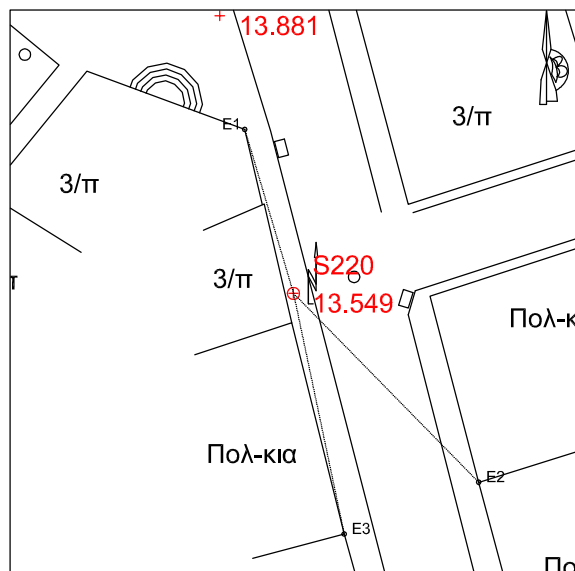

S220A
 X= 408675.219
 Y=4500323.561
 H= 13.881
 E1= 6.1
 E2= 7.56
 E3= 11.66

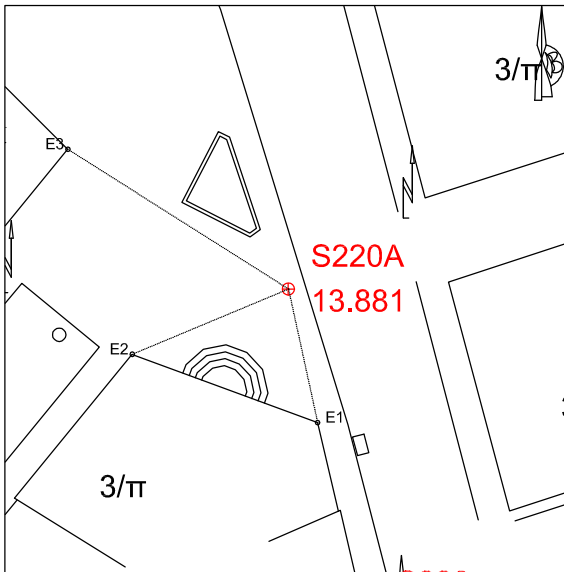

S221
 X= 408710.28
 Y=4500346.434
 H= 14.425
 E1= 3.78
 E2= 6.45
 E3= 7.13

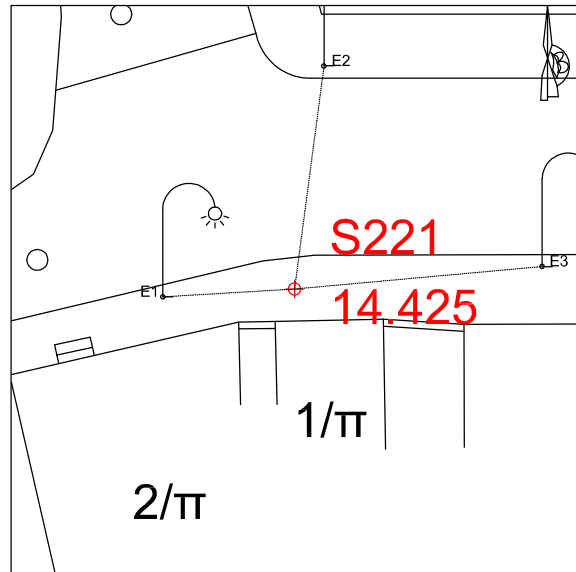

S222
 X= 408758.453
 Y=4500346.502
 H= 14.724
 E1= 7.86
 E2= 12.04
 E3= 14.42

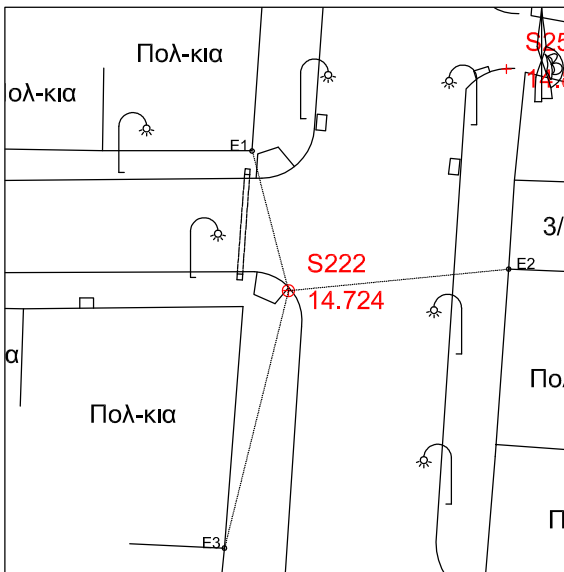

S223
 X=408705.473
 Y=4500368.092
 H= 14.552
 E1= 4.93
 E2= 8.16
 E3= 6.98

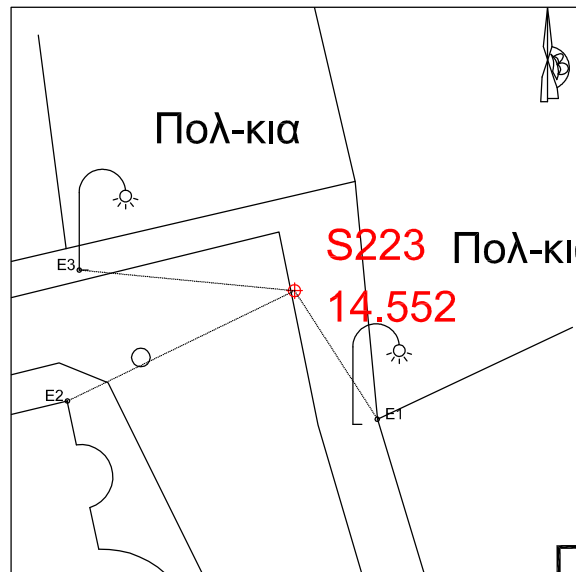

S224
 X= 408722.928
 Y=4500325.134
 H= 14.074
 E1= 5.66
 E2= 4.46
 E3= 7.08

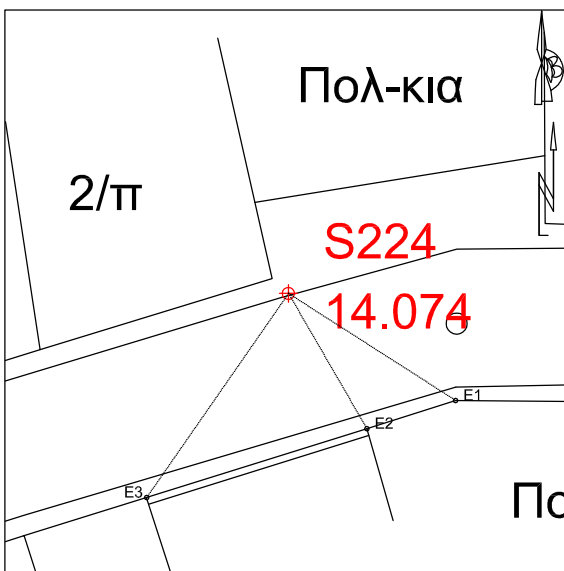

S225
 X= 408691.102
 Y=4500288.441
 H= 13.276
 E1= 7.17
 E2= 11.26
 E3= 6.9



S226
 X= 408661.693
 Y=4500274.104
 H= 13.101
 E1= 16.69
 E2= 8.22
 E3= 10.97

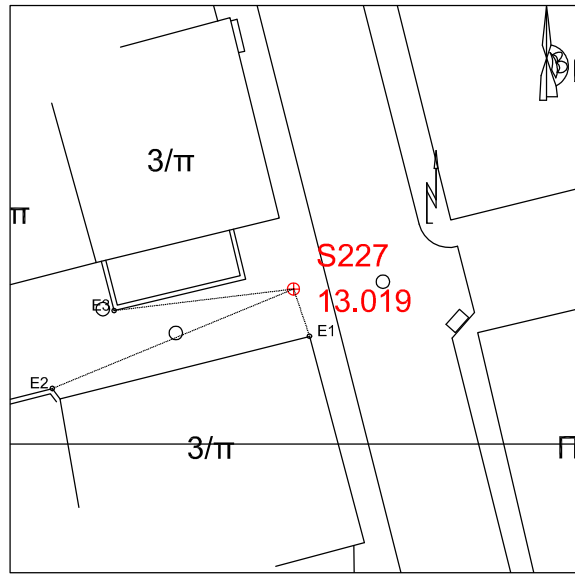
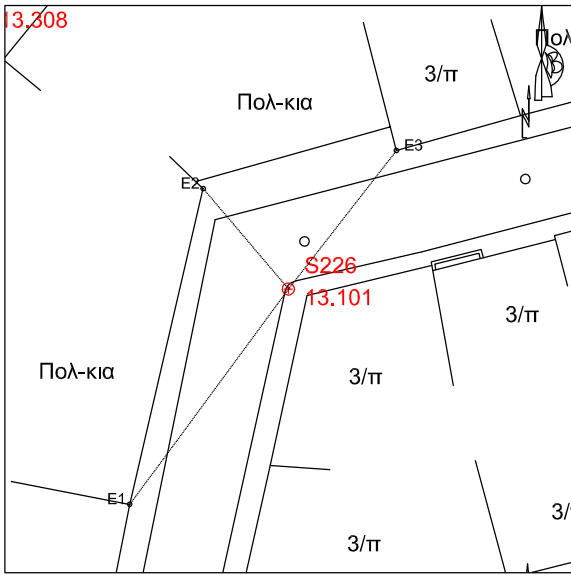

S227
 X= 408691.908
 Y=4500256.863
 H= 13.019
 E1= 2.21
 E2= 11.57
 E3= 8.02

S228
 X= 408722.034
 Y=4500295.784
 H= 13.671
 E1= 9.93
 E2= 16.58
 E3= 14.83

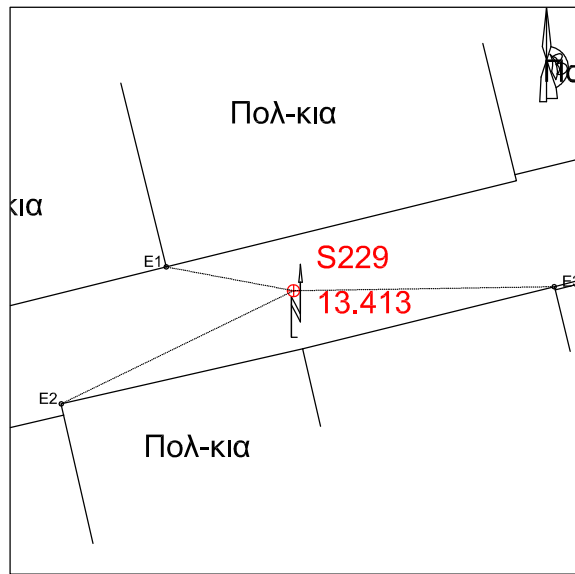
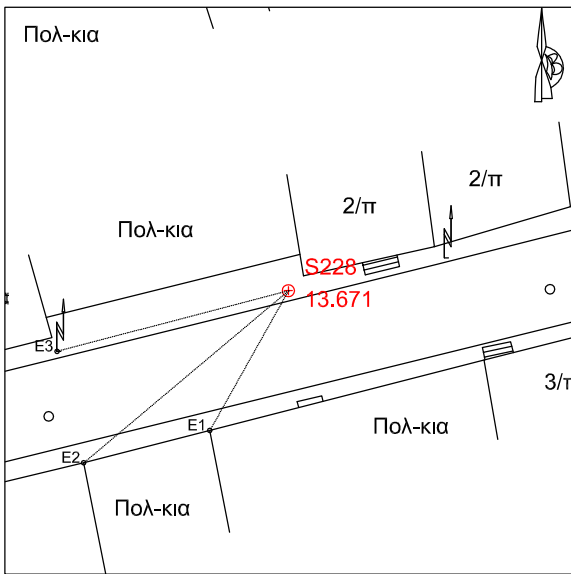

S229
 X= 408720.018
 Y=4500262.717
 H= 13.413
 E1= 5.71
 E2= 11.41
 E3= 11.52

S230
 X= 408706.288
 Y=4500220.979
 H= 12.789
 E1= 1.66
 E2= 10.32
 E3= 9.86

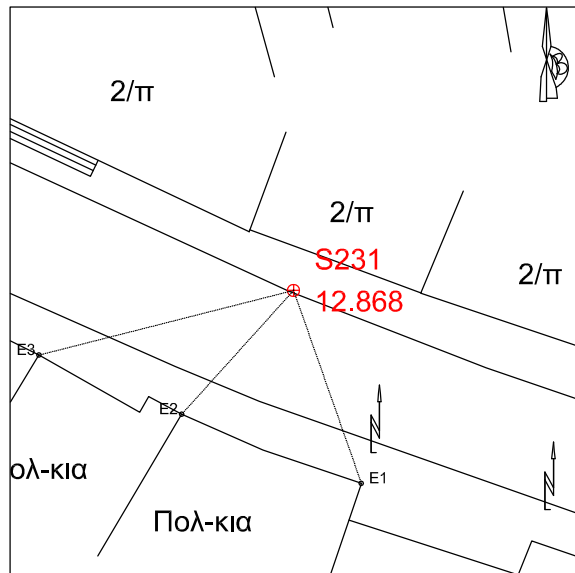
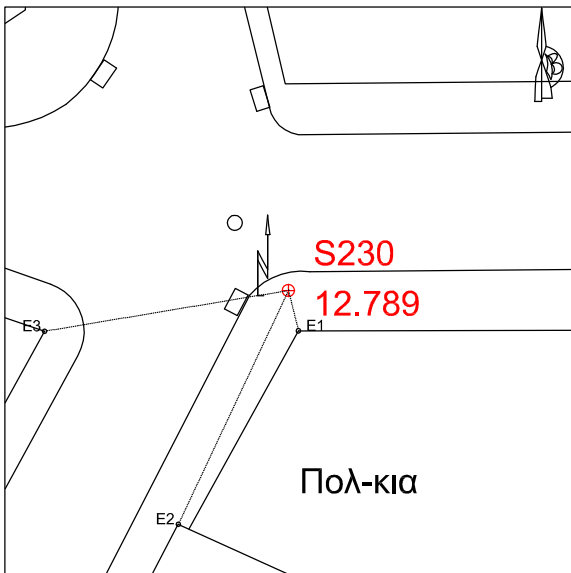

S231
 X= 408672.015
 Y=4500235.813
 H= 12.868
 E1= 9.75
 E2= 7.96
 E3= 12.52

S232
 X= 408691.885
 Y=500193.269
 H= 12.028
 E1= 11.79
 E2= 8.78
 E3= 12.12

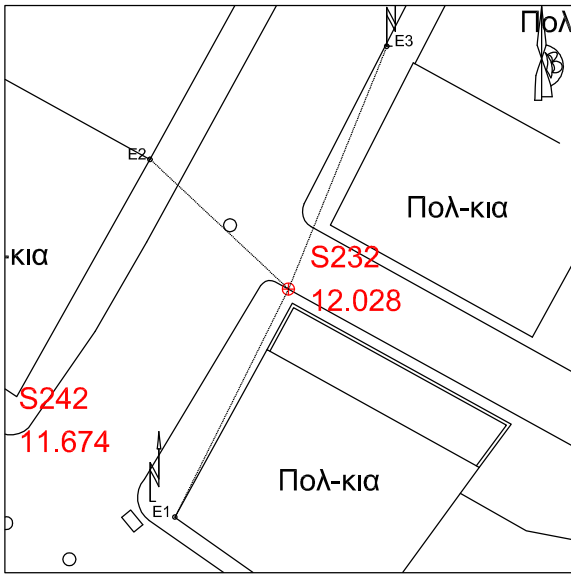

S233
 X= 408727.24
 Y=4500228.229
 H= 13.088
 E1= 10.43
 E2= 9.03
 E3= 13.05

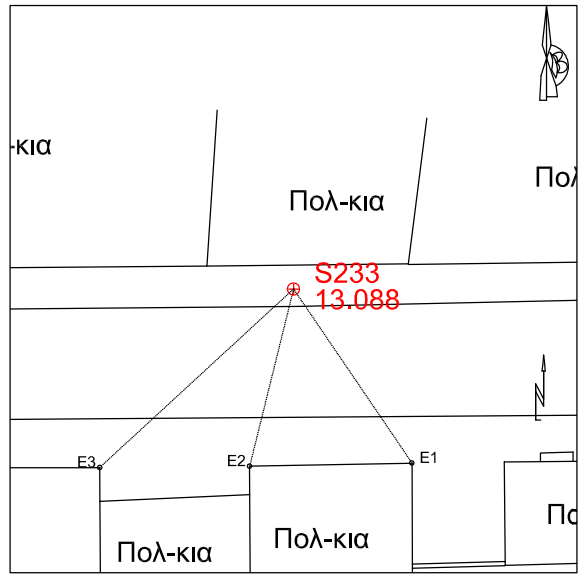

S234
 X= 408648.087
 Y=4500240.066
 H= 12.740
 E1= 6.86
 E2= 8.35
 E3= 6.41

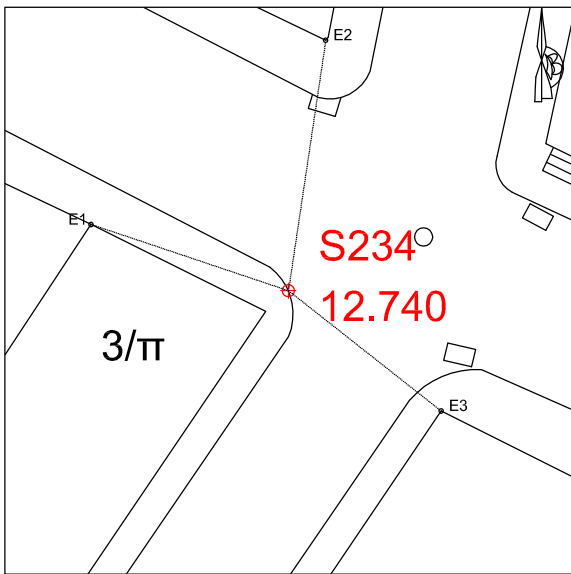

S235
 X= 408632.704
 Y=4500216.064
 H= 12.243
 E1= 12.15
 E2= 6.22
 E3= 7.67

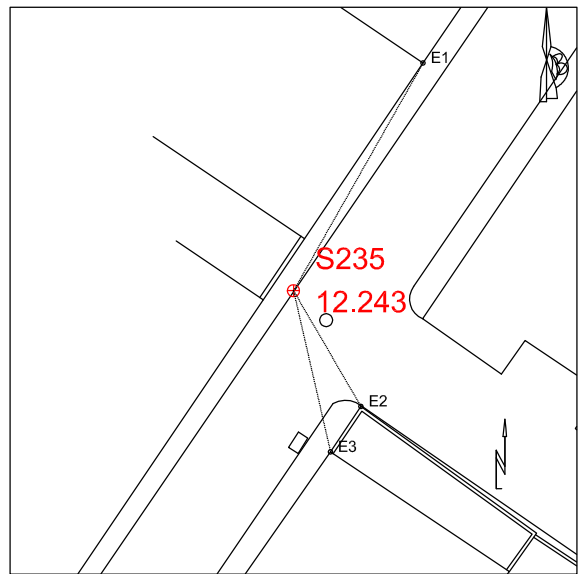

S237X=
 408565.85
 Y=4500235.372
 H= 11.802
 E1= 14.52
 E2= 7.39
 E3= 7.8

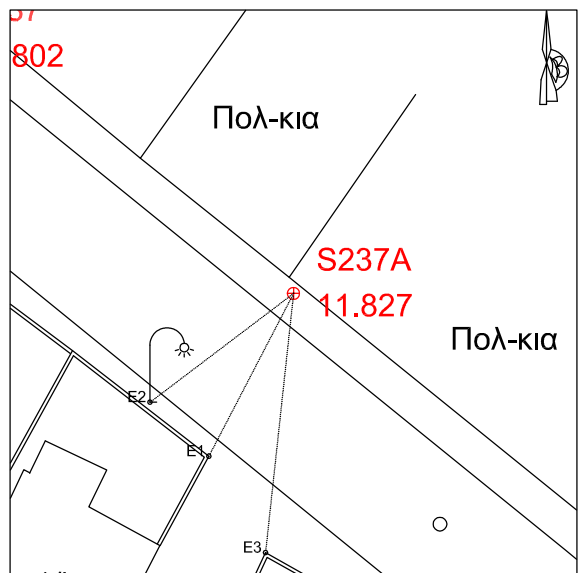
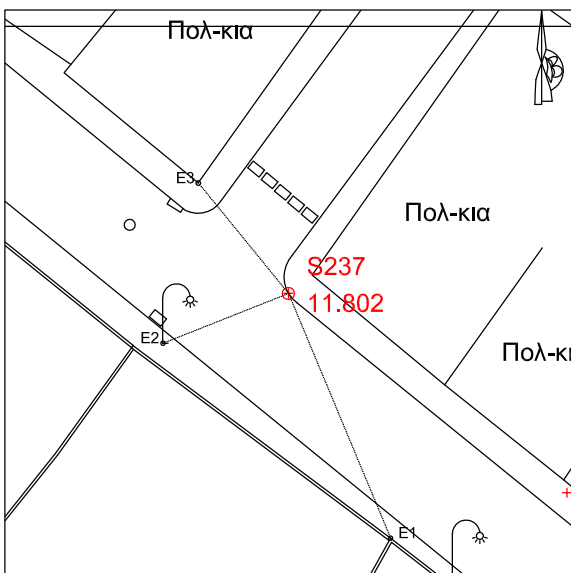

S237AX=
 408581.108
 Y=4500224.468
 H= 11.827
 E1= 8.01
 E2= 7.87
 E3= 11.39

S238
 X= 408559.879
 Y=4500294.793
 H= 12.702
 E1= 10.19
 E2= 9.9
 E3= 9.5

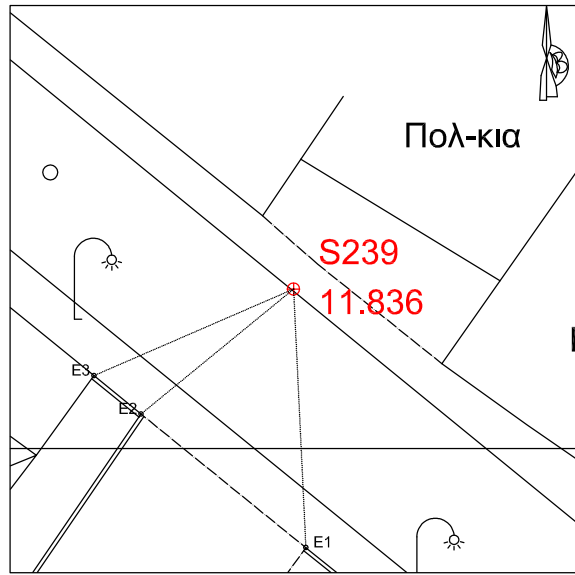
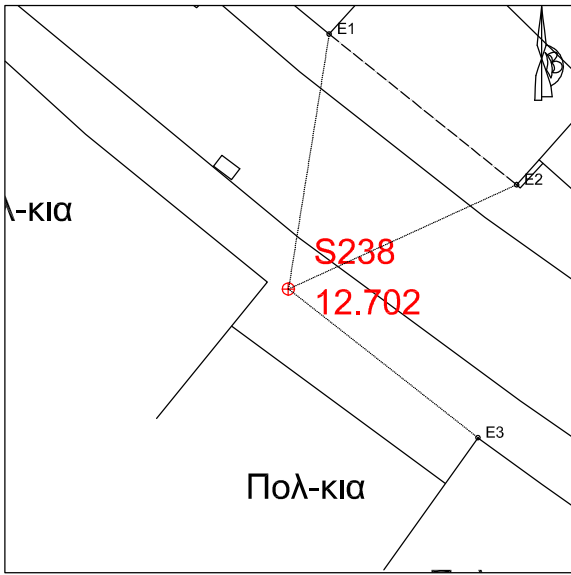

S239
 X= 408540.134
 Y=4500256.404
 H= 11.836
 E1= 10.4
 E2= 7.92
 E3= 8.74

S240
 X= 408616.741
 Y=4500188.672
 H= 11.641
 E1= 3.18
 E2= 12.04
 E3= 6.83

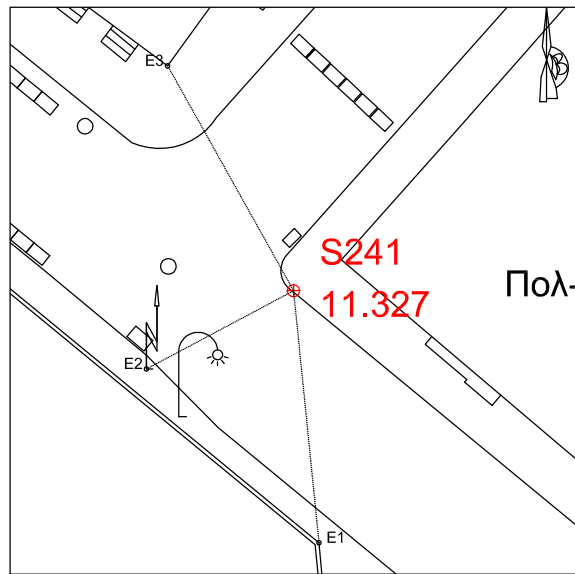
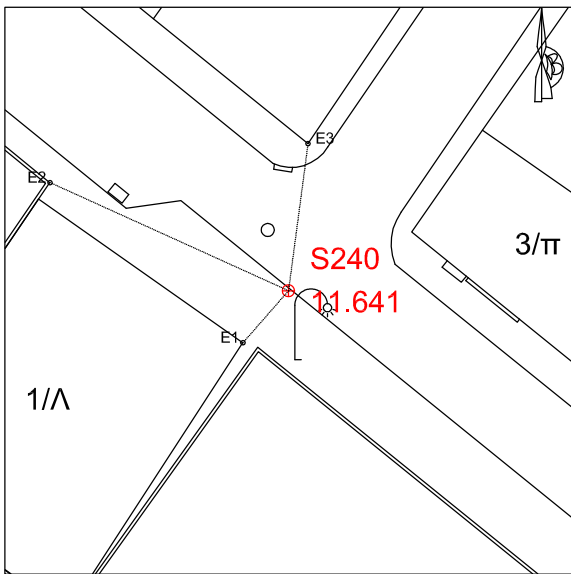

S241
 X= 408662.013
 Y=4500156.583
 H= 11.327
 E1= 9.76
 E2= 6.42
 E3= 9.92

S242
 X= 408678.409
 Y=4500186.733
 H= 11.67
 E1= 9.59
 E2= 4.7
 E3= 10.02

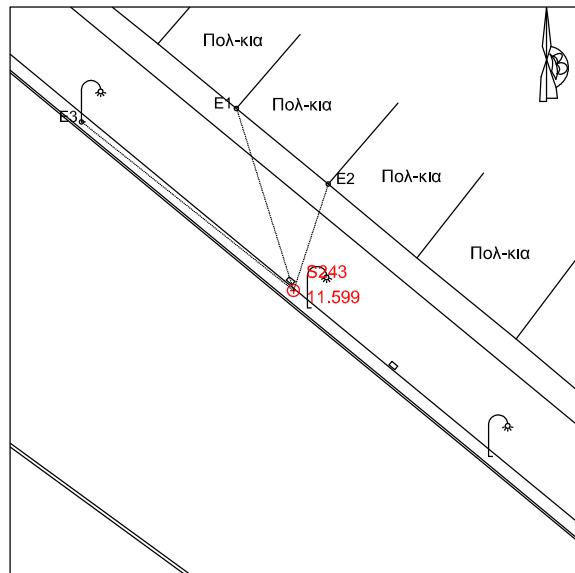
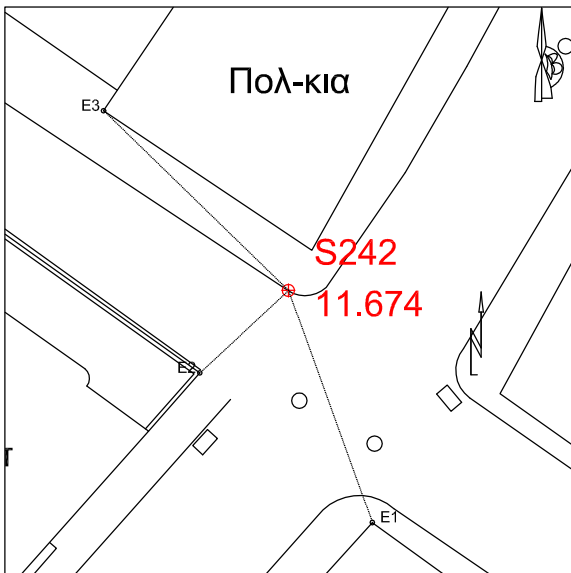

S243
 X= 408697.942
 Y=4500119.102
 H= 11.599
 E1= 14.95
 E2= 8.78
 E3= 21.24

S244X=408756.961
Y=4500073.249
H= 12.286
E1= 5.12
E2= 6.73
E3= 15.77

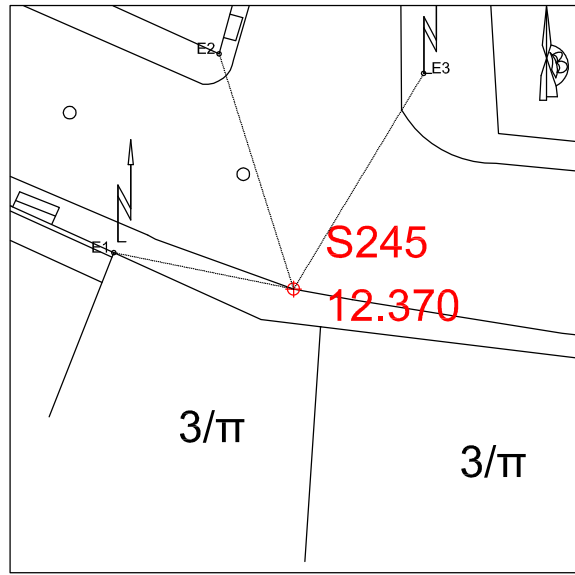
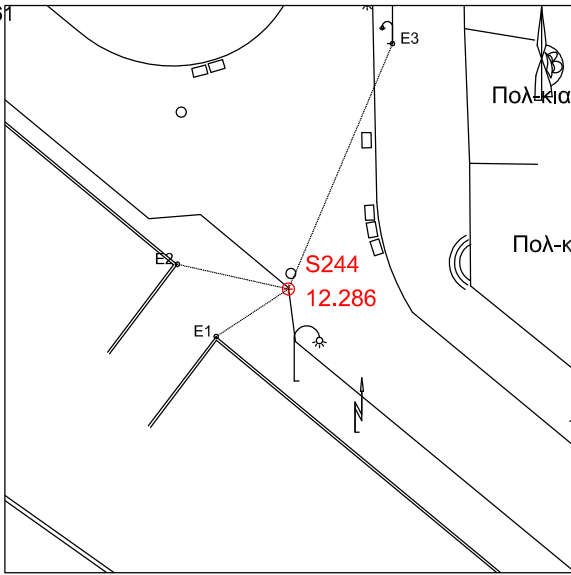

S245
X= 408730.168
Y=4500149.381
H= 12.370
E1= 5.79
E2= 7.79
E3= 7.95

S246
X= 408733.556
Y=4500182.209
H= 12.551
E1= 8.93
E2= 10.4
E3= 8.12

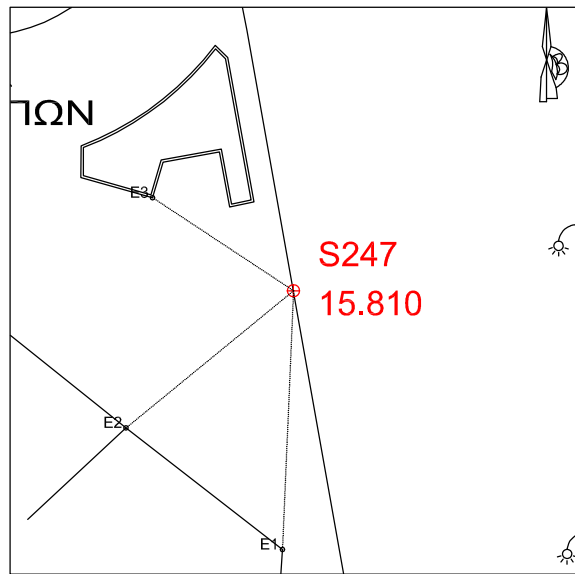
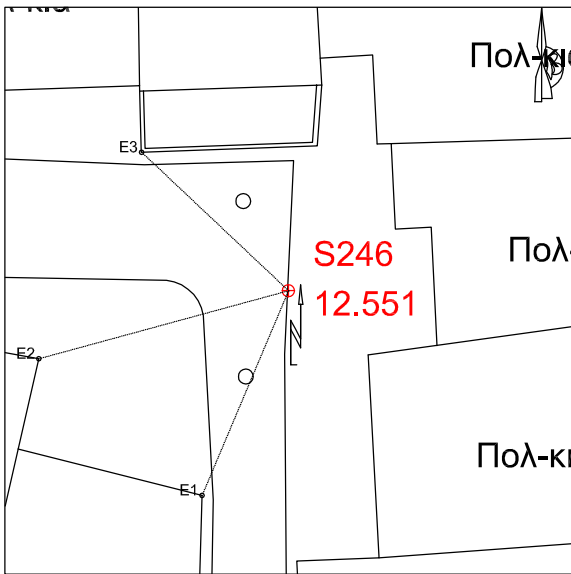

S247
X= 408761.654
Y=4500434.46
H= 15.810
E1= 10.52
E2= 8.79
E3= 6.85

S248
X= 408794.749
Y=4500453.324
H= 16.266
E1= 10.26
E2= 12.45
E3= 9.08

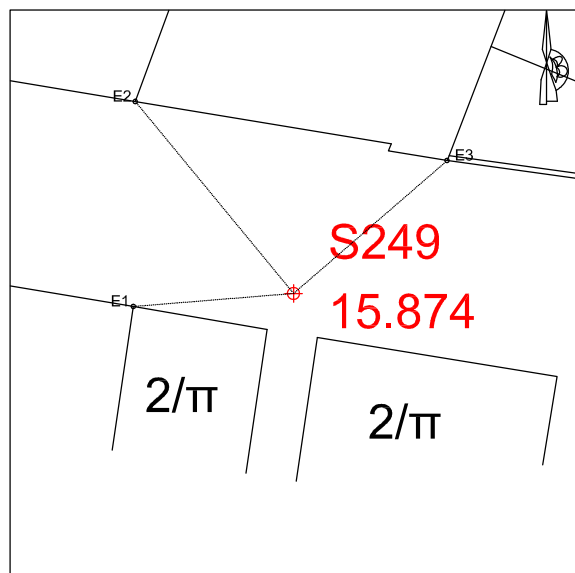
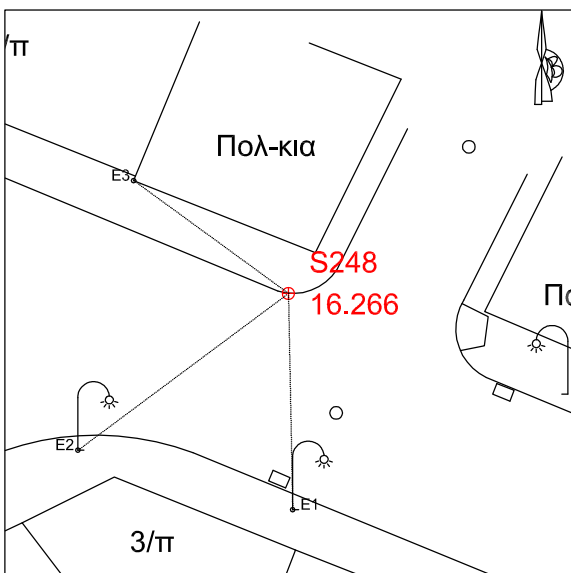

S249
X= 408794.279
Y=4500421.957
H= 15.874
E1= 4.64
E2= 7.19
E3= 5.86

S250
 X= 408773.615
 Y=4500402.323
 H= 15.403
 E1= 2.6
 E2= 11.27
 E3= 8.64

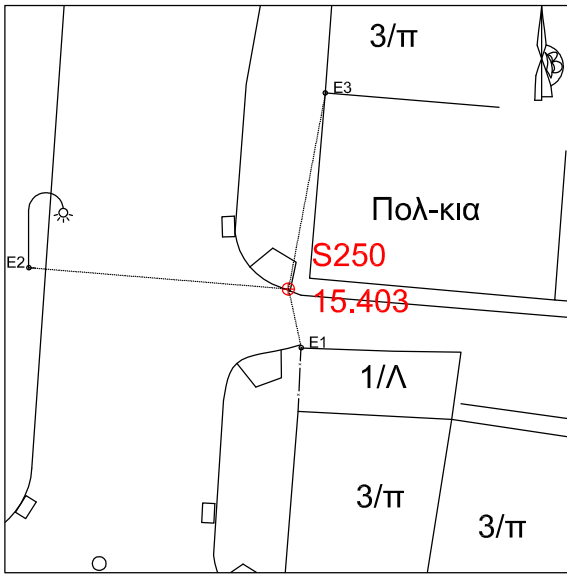

S251
 X= 408761.359
 Y=4500383.608
 H= 15.174
 E1= 9.54
 E2= 13.54
 E3= 8.21

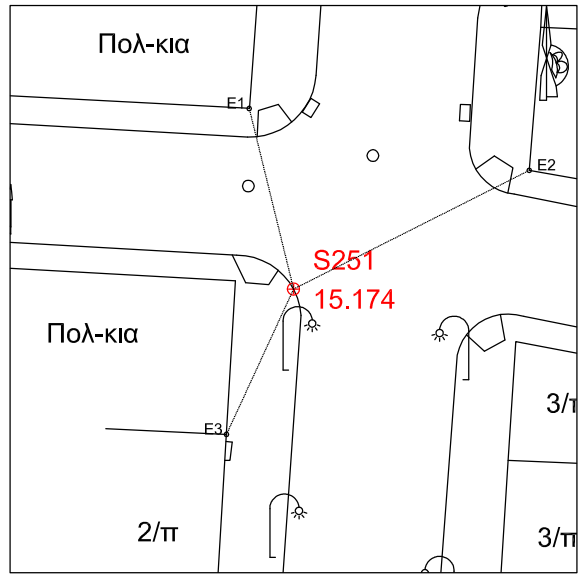

S252
 X= 408807.433
 Y=4500399.738
 H= 16.026
 E1= 7.28
 E2= 6.74
 E3= 14.74



S253
 X= 408806.697
 Y=4500380.738
 H= 15.456
 E1= 9.57
 E2= 6.45
 E3= 16.14

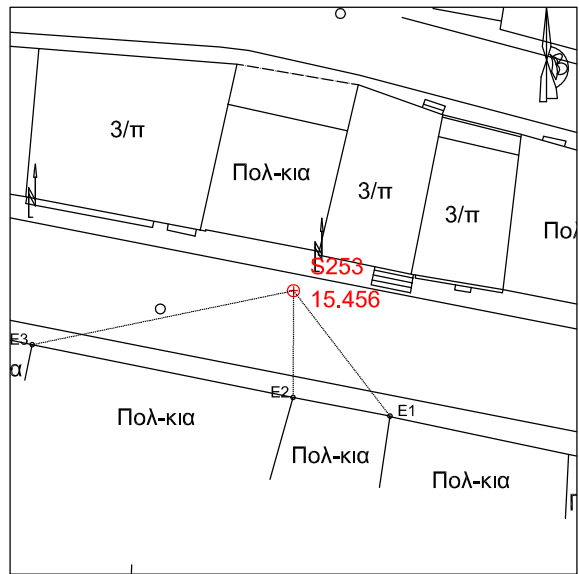

S254
 X= 408770.319
 Y=4500358.555
 H= 14.829
 E1= 6.05
 E2= 11.51
 E3= 8.14

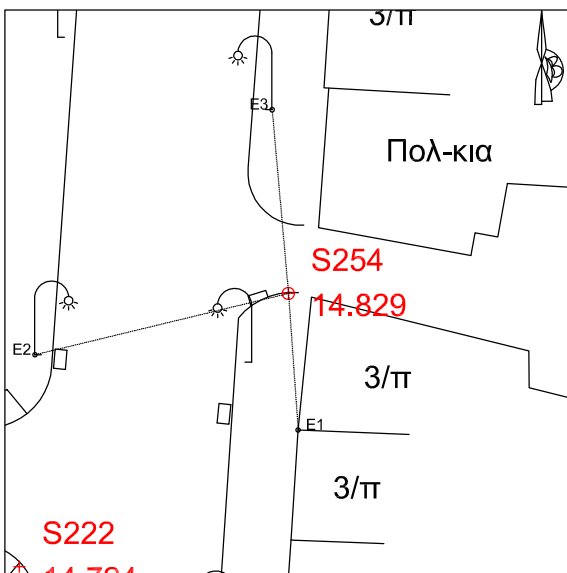

S255
 X= 408785.399
 Y=4500358.767
 H= 15.248
 E1= 7.62
 E2= 5.13
 E3= 5.24

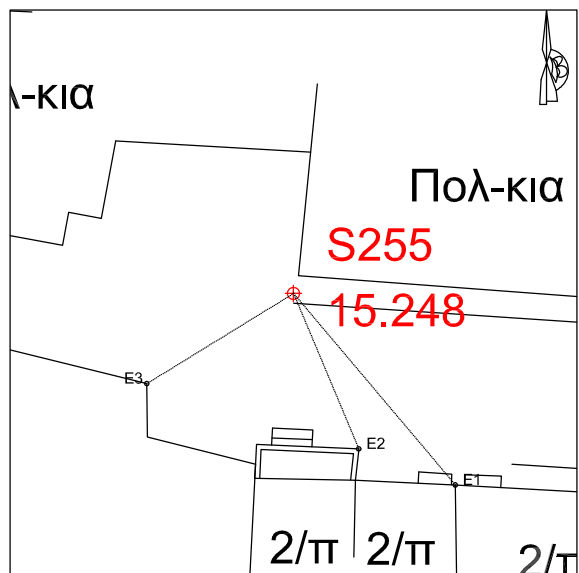

S256
 X= 408766.917
 Y=4500322.254
 H= 14.505
 E1= 8.53
 E2= 11.01
 E3= 13.22

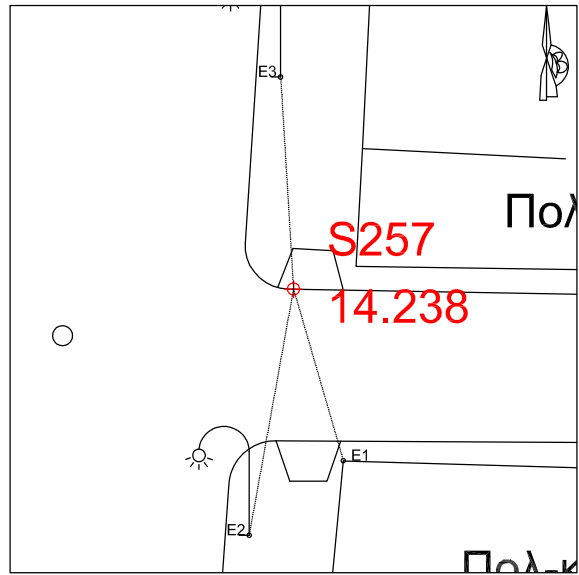
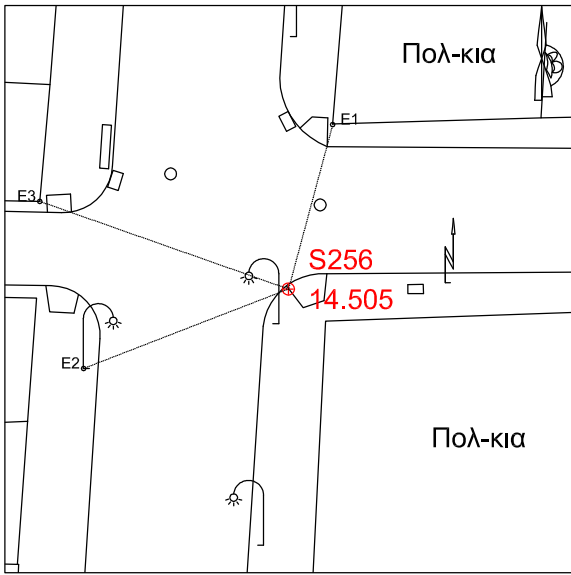

S257
 X= 408766.061
 Y=4500303.092
 H= 14.238
 E1= 5.34
 E2= 7.47
 E3= 6.34

S258
 X= 408801.287
 Y=4500329.211
 H= 14.926
 E1= 9.39
 E2= 7.95
 E3= 14.12

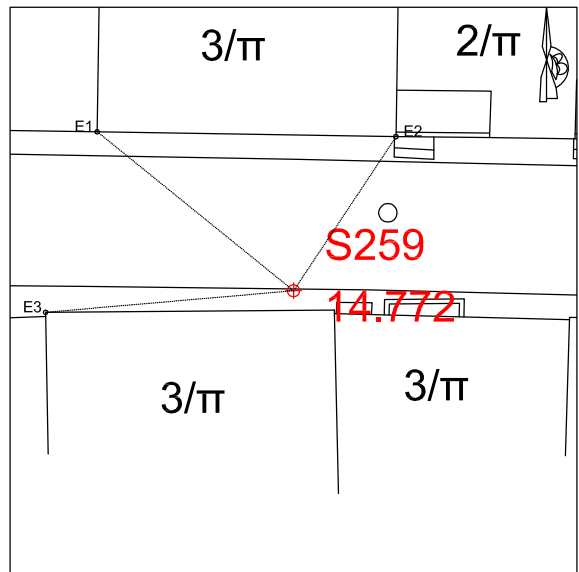
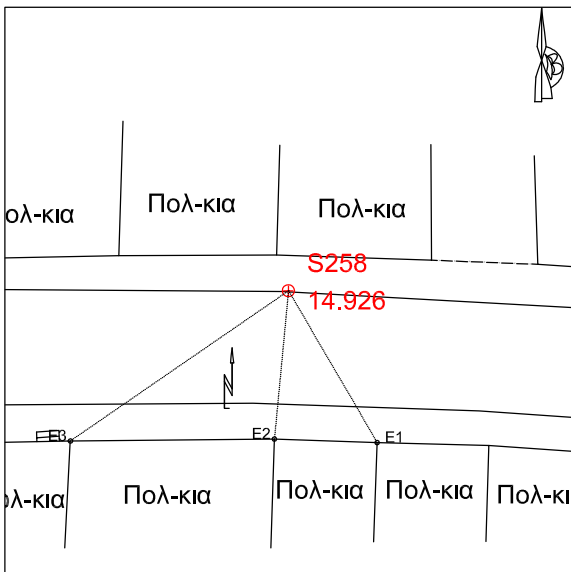

S259
 X= 408797.225
 Y=4500298.285
 H= 14.772
 E1= 8.16
 E2= 5.98
 E3= 8.04

S260
 X= 408765.077
 Y=4500275.228
 H= 14.012
 E1= 9.67
 E2= 11.02
 E3= 6.07

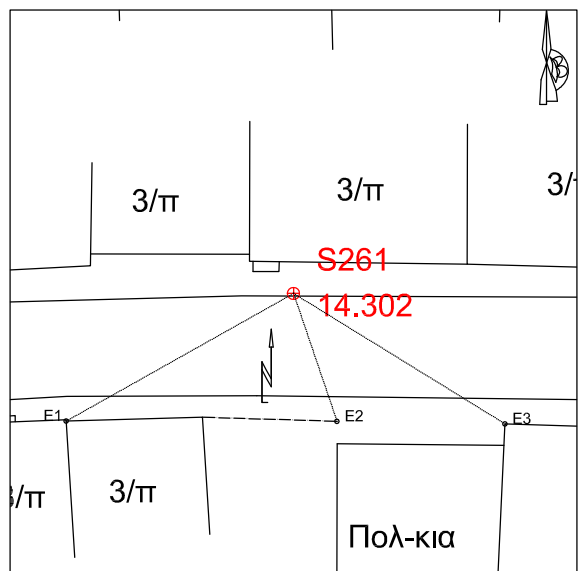
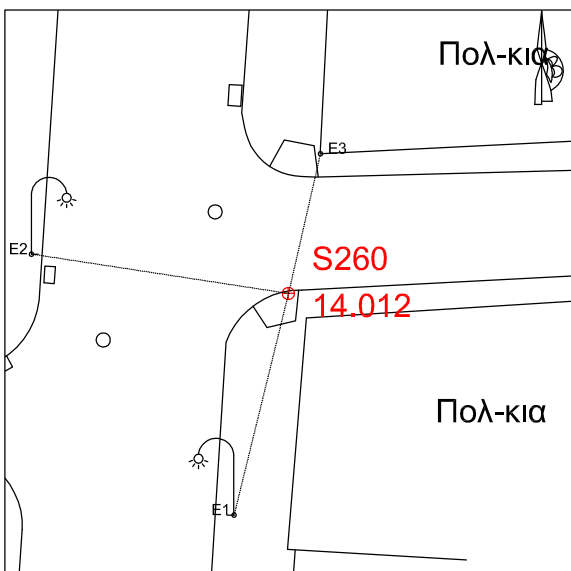

S261
 X= 408796.952
 Y=4500281.014
 H= 14.302
 E1= 11.46
 E2= 5.93
 E3= 10.92

S262
X= 408750.039
Y=4500220.743
H= 13.313
E1= 12.41
E2= 9.11
E3= 9.89

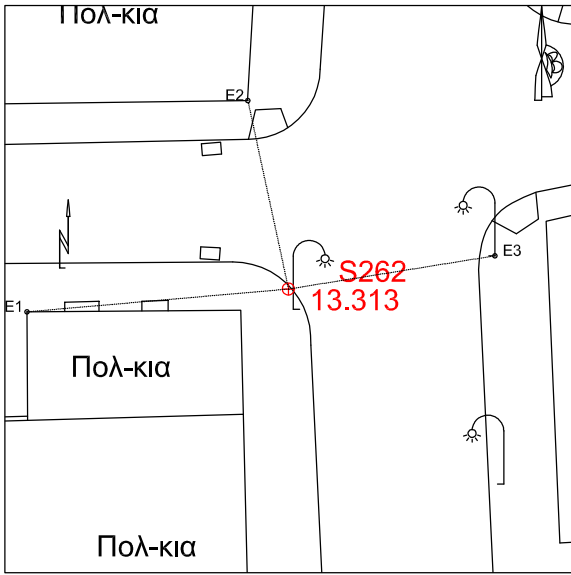

S263
X= 408802.953
Y=4500238.774
H= 13.862
E1= 13.09
E2= 8.58
E3= 11.2

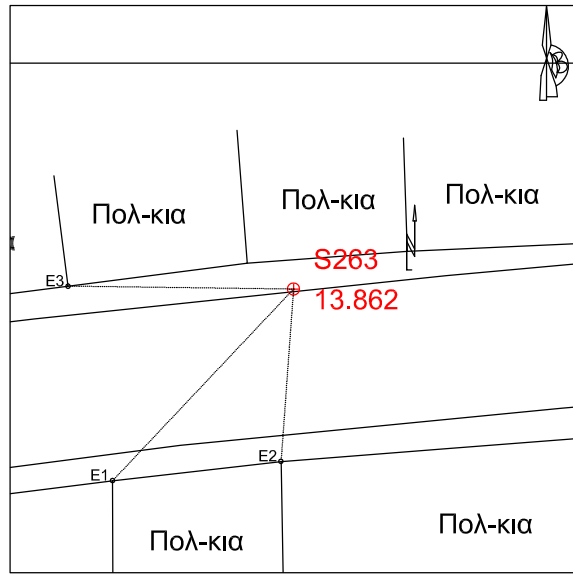

S264
X= 408763.35
Y=4500193.332
H= 13.138
E1= 9.49
E2= 12.84
E3= 15.43

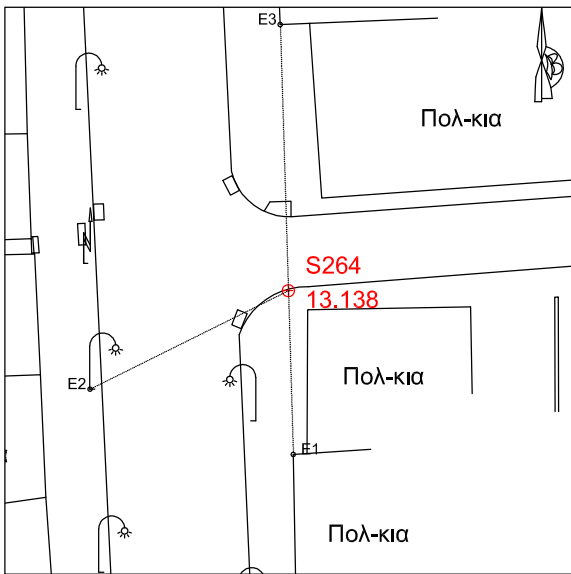

S265
X= 408761.912
Y=4500153.306
H= 12.850
E1= 15.89
E2= 12.82
E3= 9.97

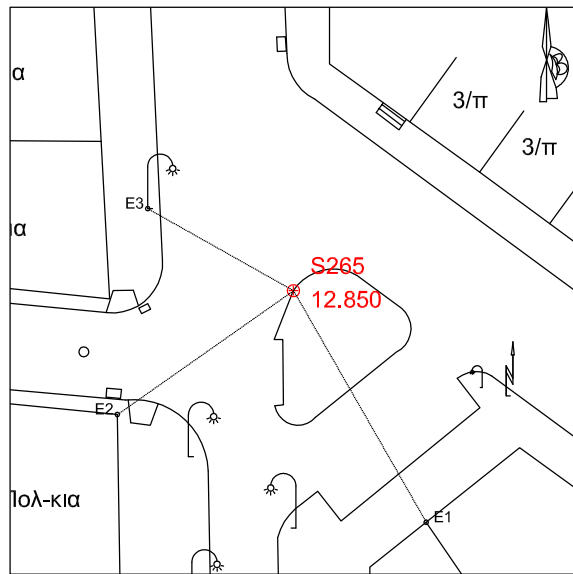

S266
 X= 408823.776
 Y=4500200.907
 H= 13.120
 E1= 7.03
 E2= 6.33
 E3= 3.96

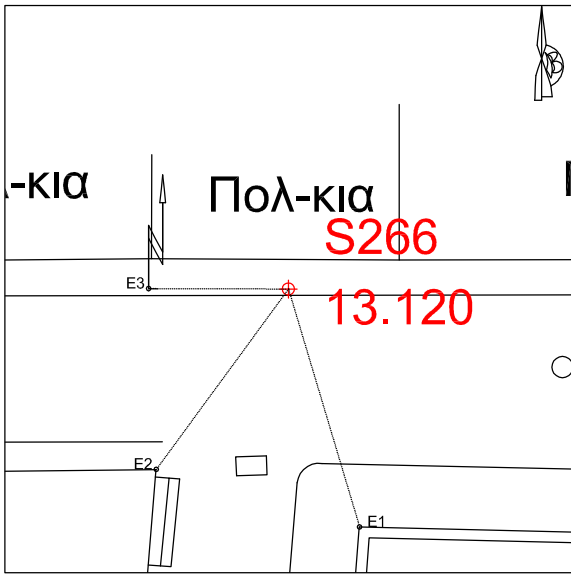

S267
 X= 408763.819
 Y=4500101.188
 H= 12.475
 E1= 6.3
 E2= 12.55
 E3= 10.36

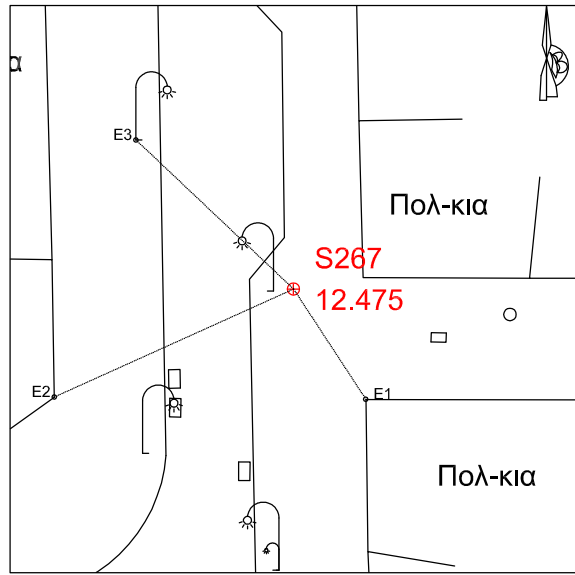

S268
 X= 408786.552
 Y=4500137.592
 H= 12.232
 E1= 12.85
 E2= 15.34
 E3= 10.44

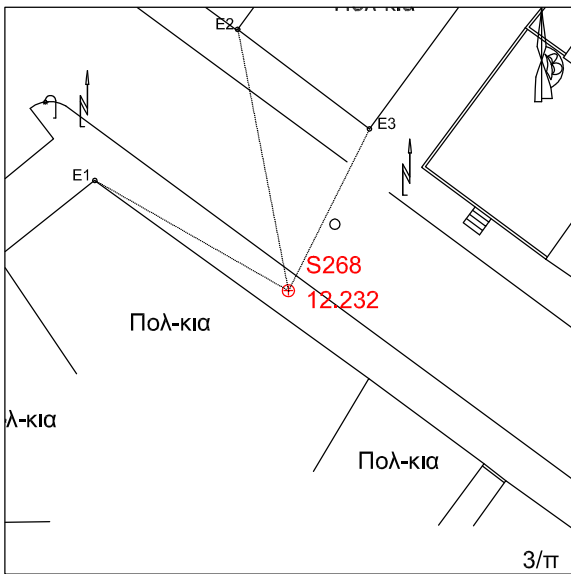

S269
 X= 408800.148
 Y=4500090.926
 H= 11.842
 E1= 9.12
 E2= 6.15
 E3= 19.68

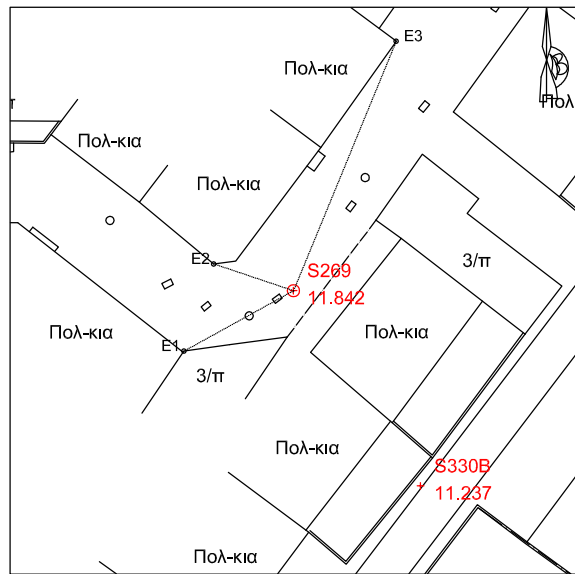

S270
 X= 408817.046
 Y=4500176.037
 H= 13.424
 E1= 3.63
 E2= 4.53
 E3= 4.15

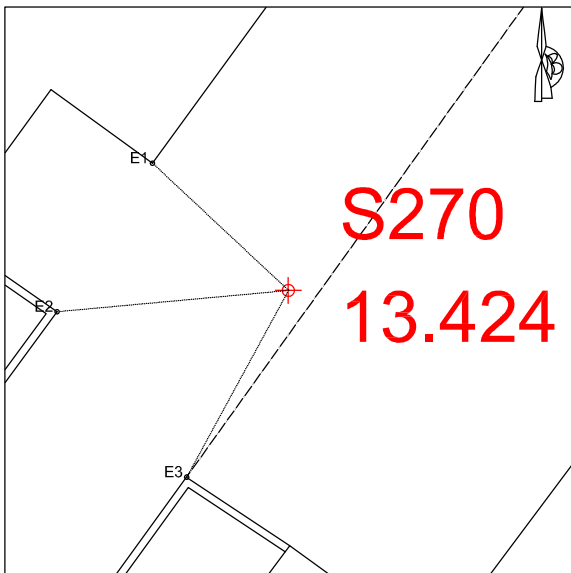

S271
 X= 408814.302
 Y=4500128.375
 H= 11.666
 E1= 11.94
 E2= 10.96
 E3= 9.16

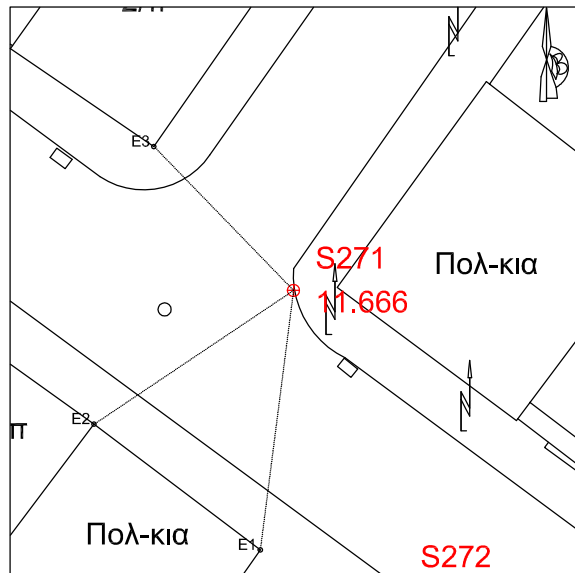

S272
X= 408819.094
Y=4500114.749
H= 11.450
E1= 2.32
E2= 6.56
E3= 9.38

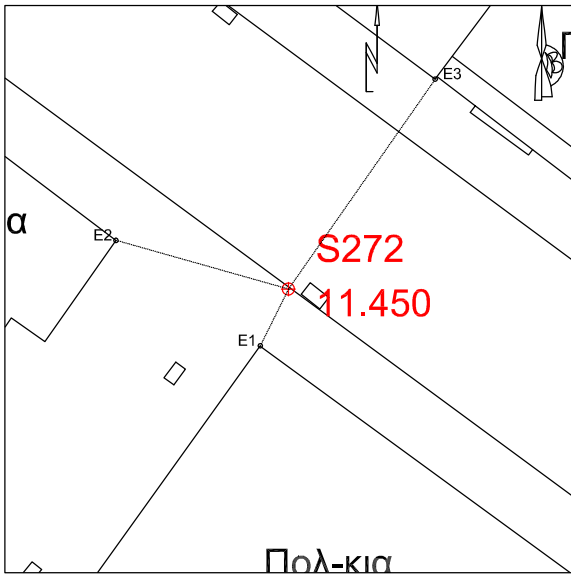

S273
X= 408838.294
Y=4500174.473
H= 12.762
E1= 11.03
E2= 15.37
E3= 14.05

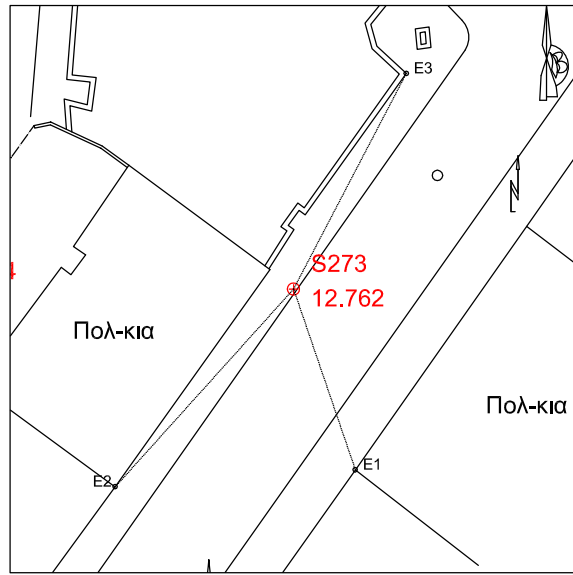

S274
X= 408849.916
Y=4500200.959
H= 13.208
E1= 9.63
E2= 17.96
E3= 11.2

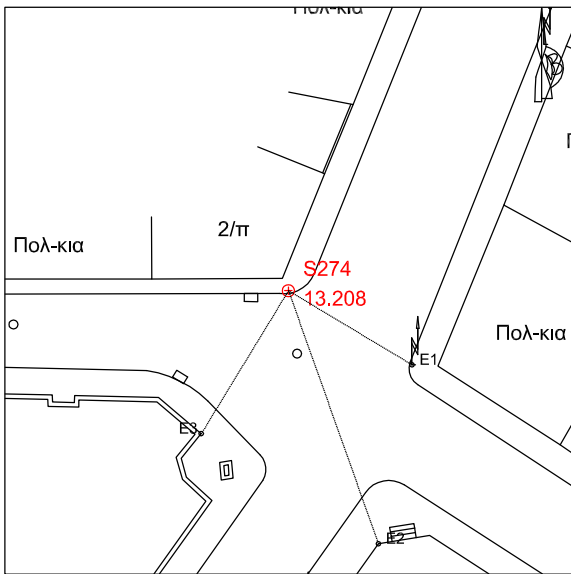

S275
X= 408875.963
Y=4500175.91
H= 12.285
E1= 8.06
E2= 1.91
E3= 9.82



S276
X= 408866.205
Y=4500241.093
H= 13.438
E1= 13.31
E2= 9.3
E3= 11.03

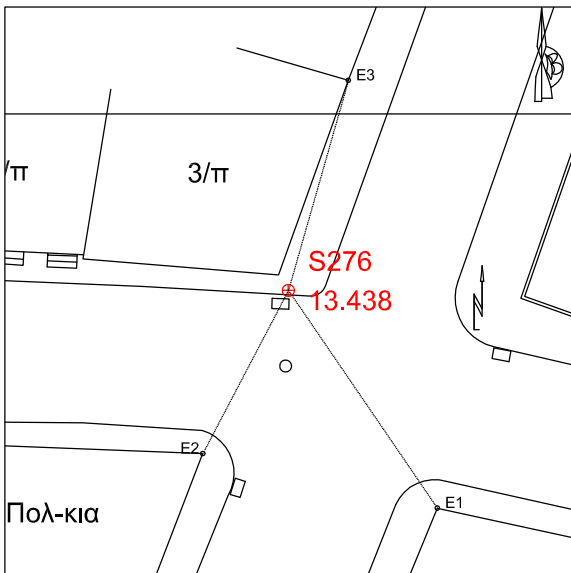

S277
X= 408887.151
Y=4500268.426
H= 14.028
E1= 11.12
E2= 11.95
E3= 14.15

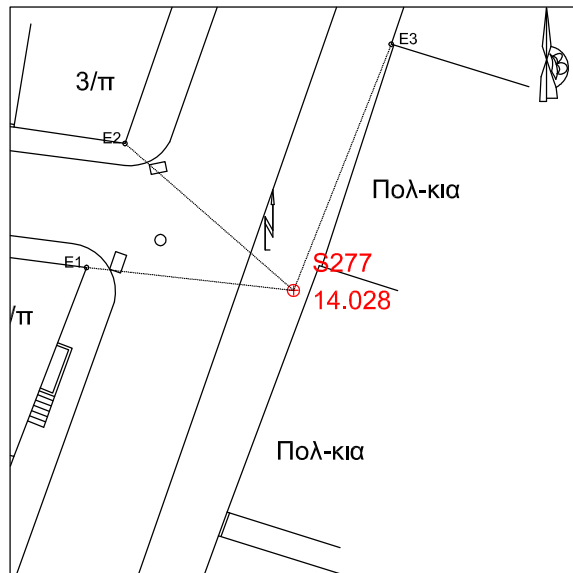

S278
 X= 408895.652
 Y=4500225.841
 H= 13.075
 E1= 13.36
 E2= 9.47
 E3= 16.59

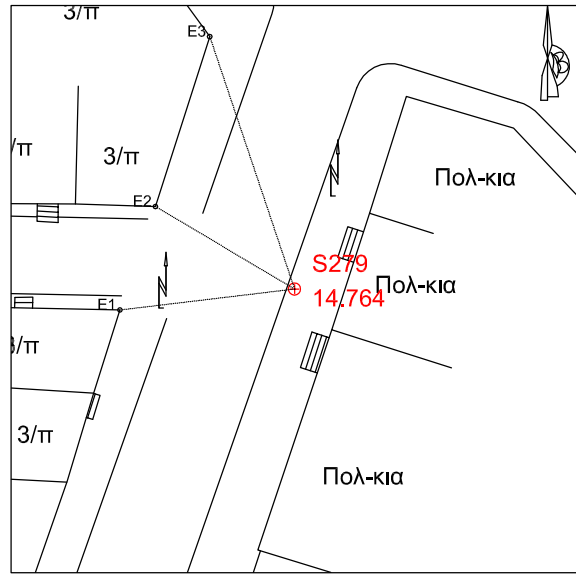
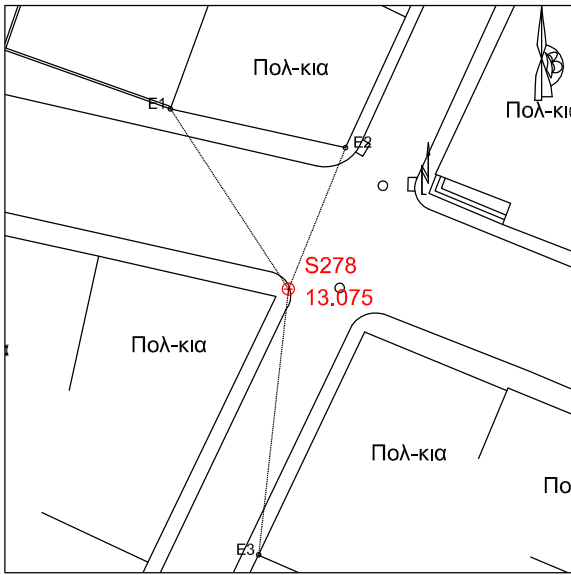

S279
 X= 408894.478
 Y=4500296.632
 H= 14.764
 E1= 10.14
 E2= 9.33
 E3= 15.37

S280
 X= 408833.932
 Y=4500280.265
 H= 14.690
 E1= 11.24
 E2= 8.52
 E3= 16.35

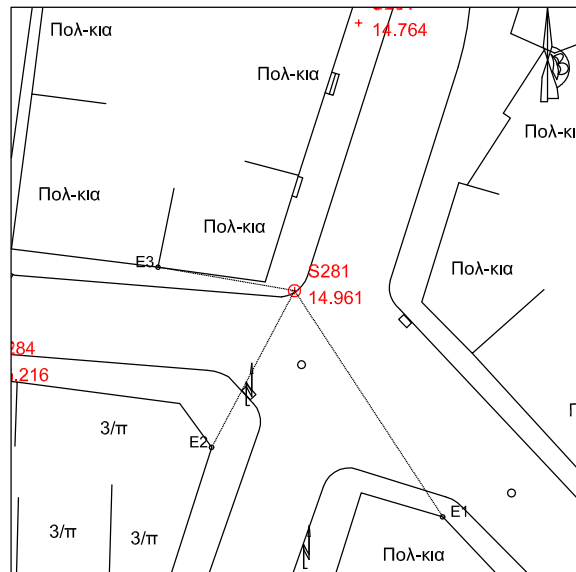
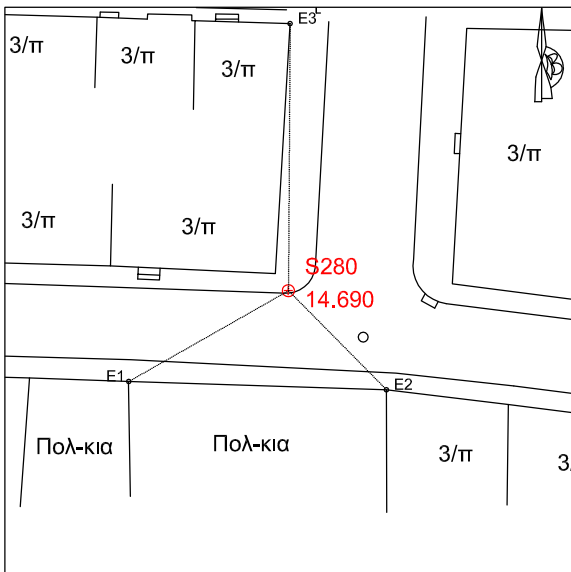

S281
 X= 408895.874
 Y=4500323.082
 H= 14.961
 E1= 20.52
 E2= 13.45
 E3= 10.51

S282
 X= 408843.611
 Y=4500301.904
 H= 15.010
 E1= 10.59
 E2= 5.72
 E3= 10.94

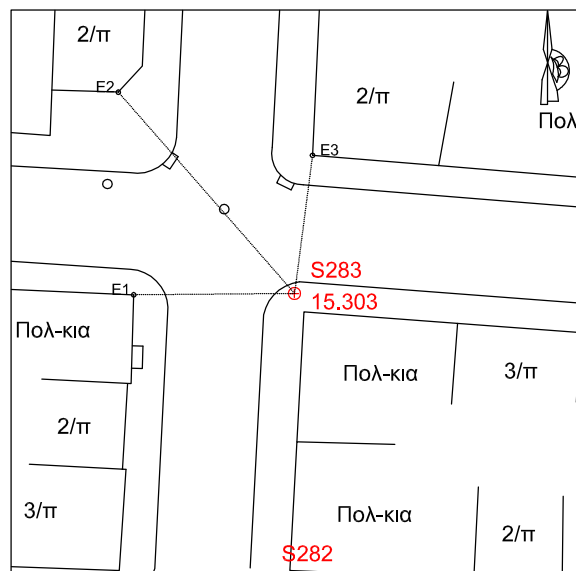
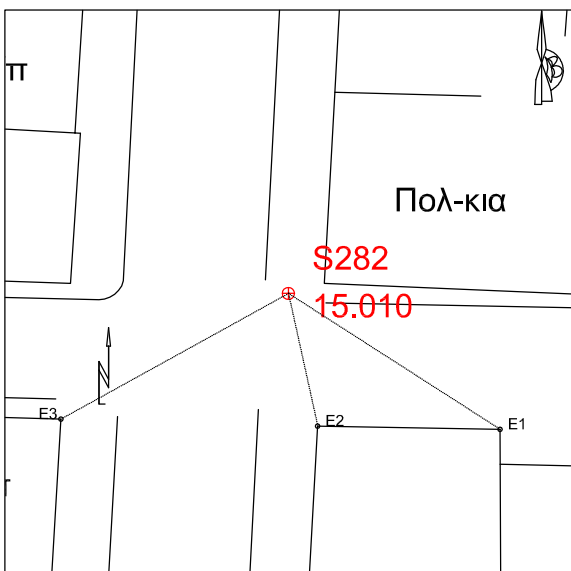

S283
 X= 408845.42
 Y=4500319.678
 H= 15.303
 E1= 10.07
 E2= 16.77
 E3= 8.73

S284
 X= 408872.013
 Y=4500317.229
 H= 15.216
 E1= 9.95
 E2= 9.33
 E3= 8.69

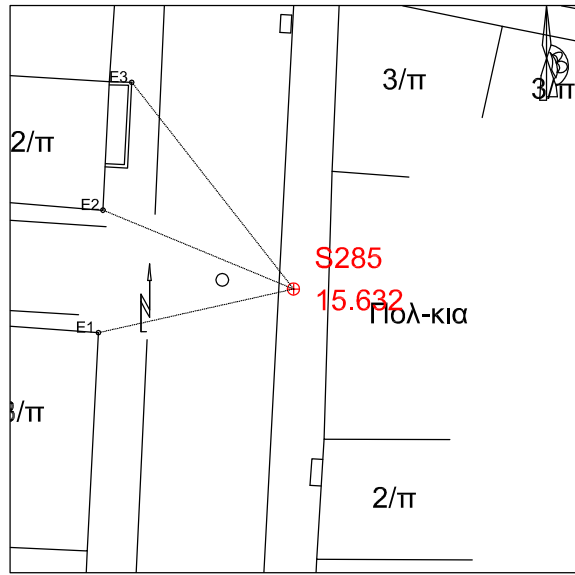
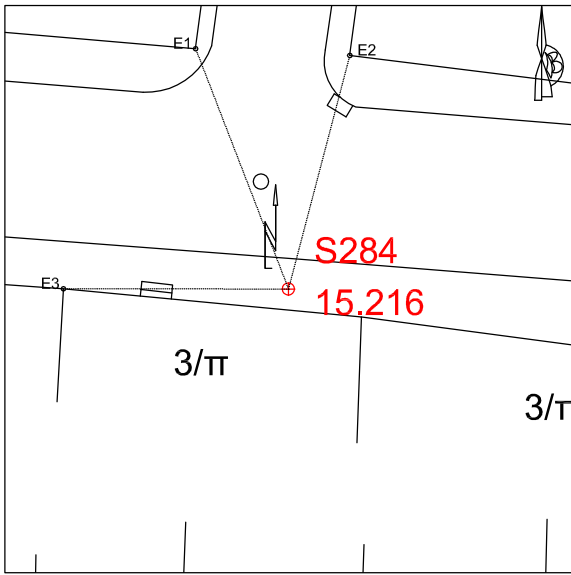

S285
 X= 408845.942
 Y=4500352.031
 H= 15.632
 E1= 9.5
 E2= 9.8
 E3= 12.48

S286
 X= 408847.91
 Y=4500367.395
 H= 15.794
 E1= 10.32
 E2= 13.93
 E3= 7.67

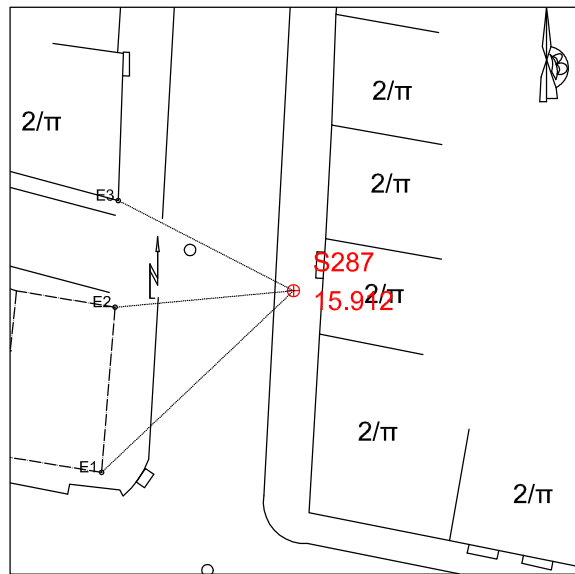
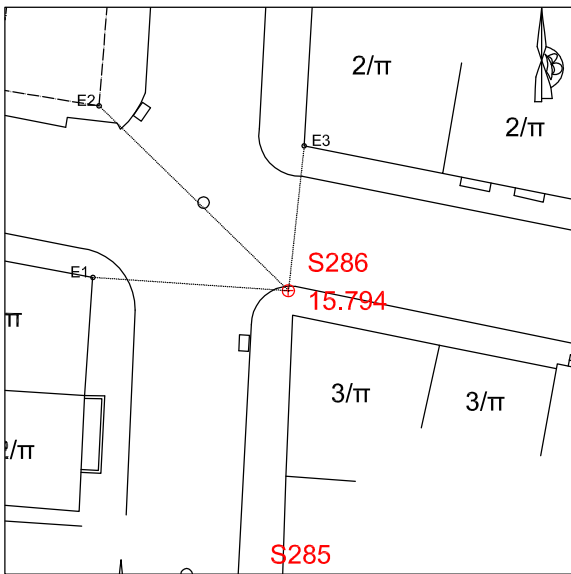

S287
 X= 408847.923
 Y=4500386.568
 H= 15.912
 E1= 13.74
 E2= 9.31
 E3= 10.24

S288
 X= 408842.459
 Y=4500423.581
 H= 15.723
 E1= 2.37
 E2= 10.53
 E3= 11.62

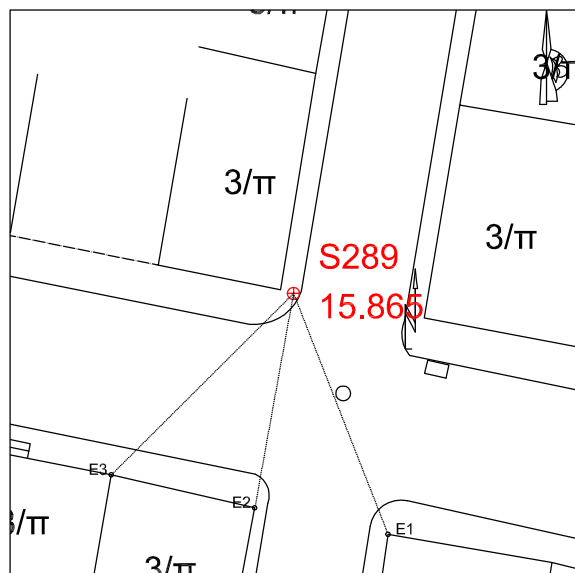
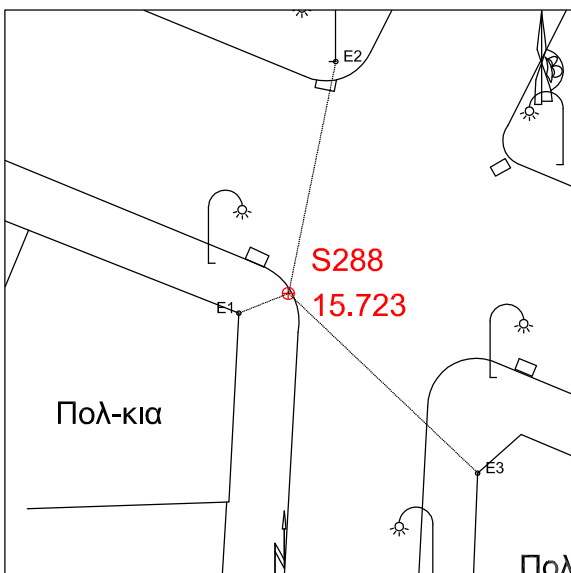

S289
 X= 408875.067
 Y=4500369.727
 H= 15.865
 E1= 10.41
 E2= 8.77
 E3= 10.35

S290
 X=408888.099
 Y=4500416.908
 H= 15.336
 E1= 13.31
 E2= 13.29
 E3= 4.1

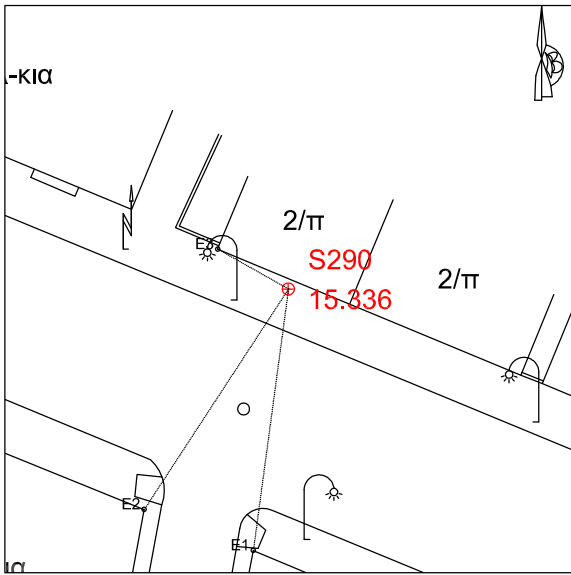

S291
 X= 408900.732
 Y=4500343.398
 H= 14.764
 E1= 14.31
 E2= 4.18
 E3= 10.23

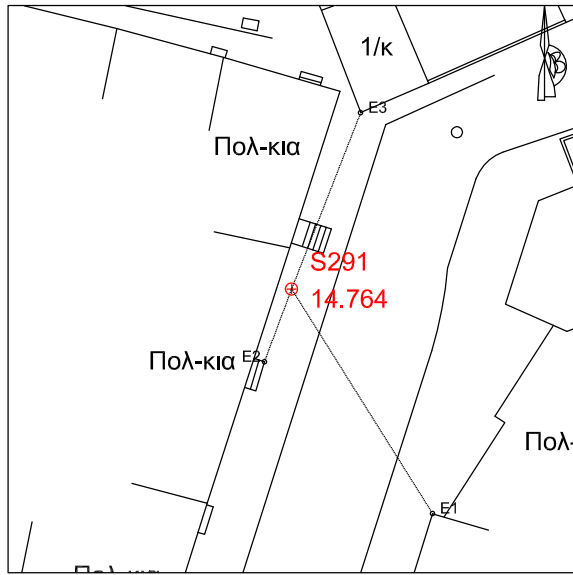

S292
 X= 408931.179
 Y=4500293.339
 H= 13.872
 E1= 14.04
 E2= 8.52
 E3= 13.65

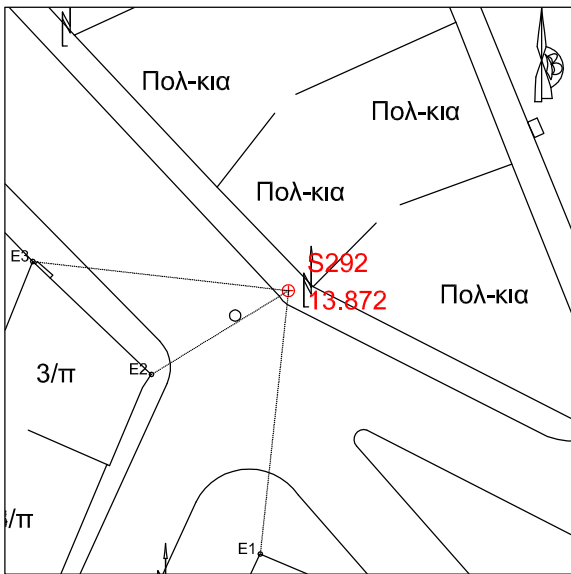

S293
 X= 408926.208
 Y=4500359.312
 H= 13.949
 E1= 8.85
 E2= 6.91
 E3= 12.52

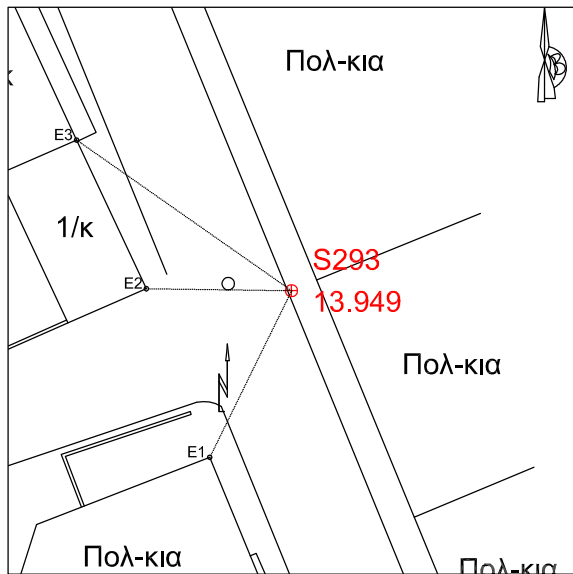

S294
 X= 408905.01
 Y=4500397.025
 H= 14.863
 E1= 11.35
 E2= 15.78
 E3= 13.55

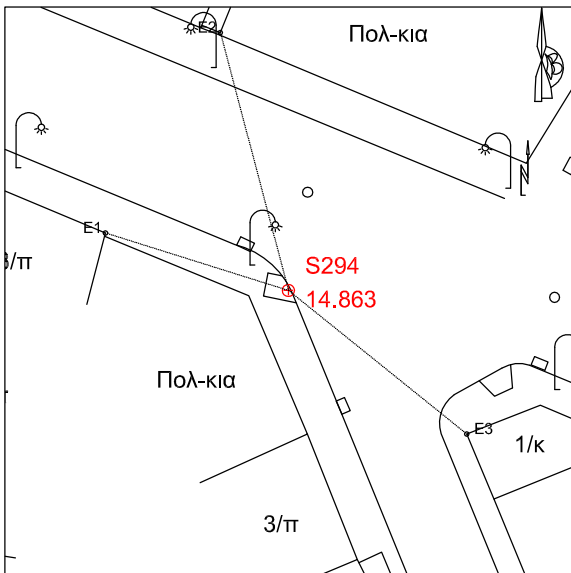

S295
 X= 408957.172
 Y=4500281.132
 H= 13.626
 E1= 8.28
 E2= 3.18
 E3= 11.85

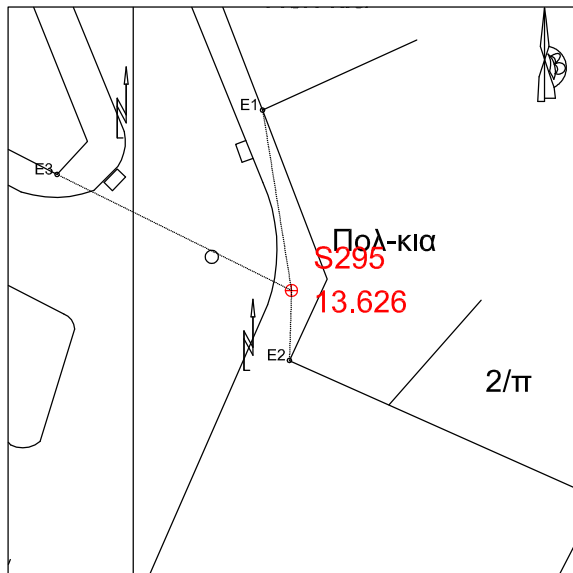

S296
X= 408939.358
Y=4500257.466
H= 13.203
E1= 5.17
E2= 11.06
E3= 10.28

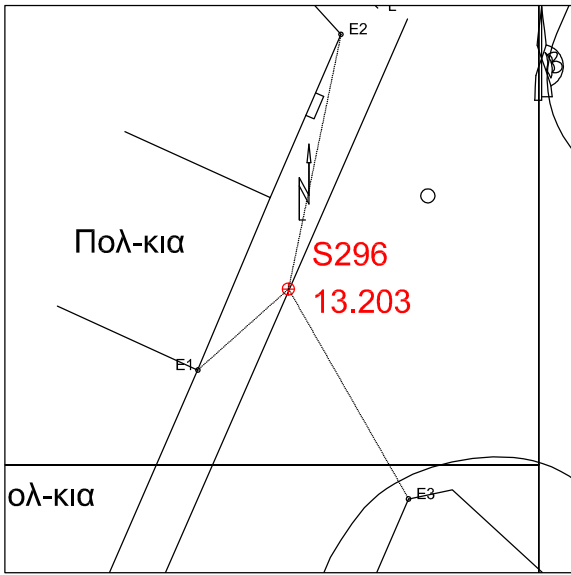

S297
X= 408977.402
Y=4500367.32
H= 15.157
E1= 12.58
E2= 18.34
E3= 11.23

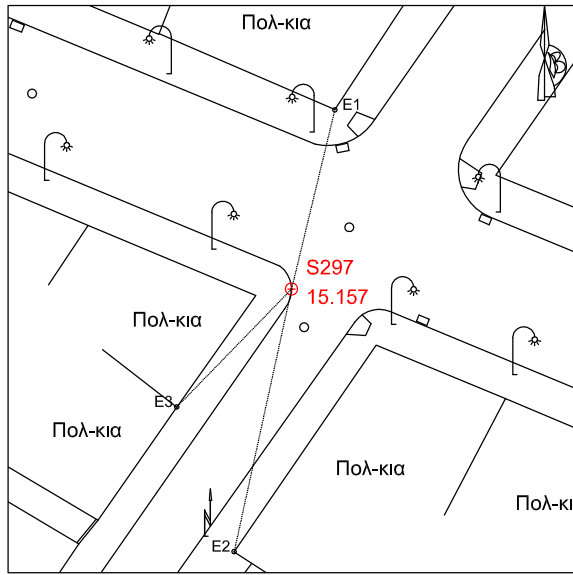

S298
X= 409020.026
Y=4500362.8
H= 15.047
E1= 13.87
E2= 18.97
E3= 12.12

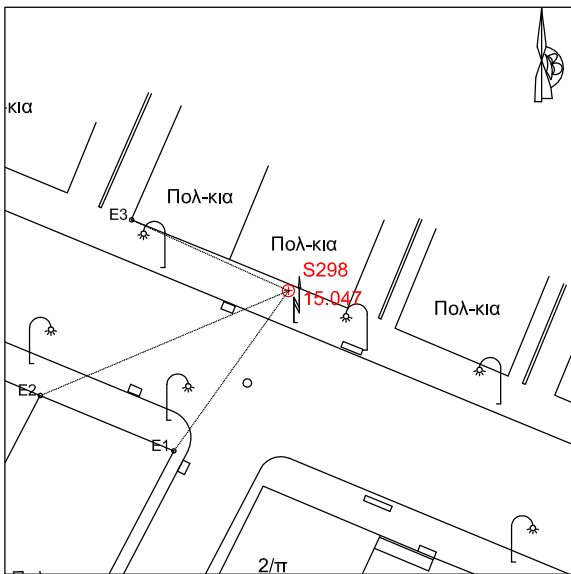

S299
X= 409070.809
Y=4500341.746
H= 14.693
E1= 8.49
E2= 14.63
E3= 13.9

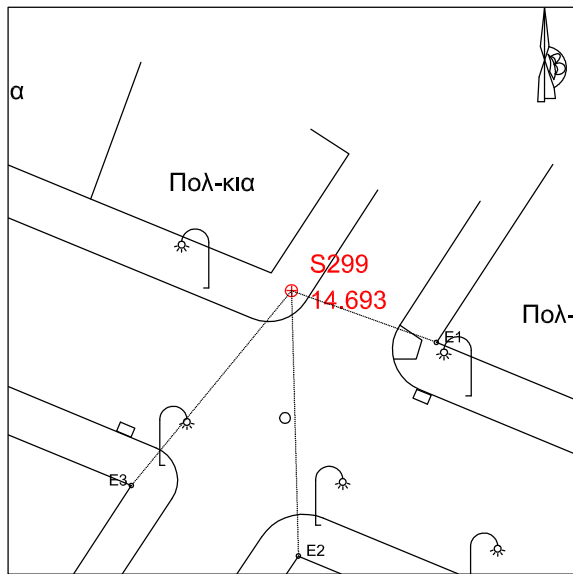

S300
X= 408985.032
Y=4500298.517
H= 14.162
E1= 6.17
E2= 13.28
E3= 11.39

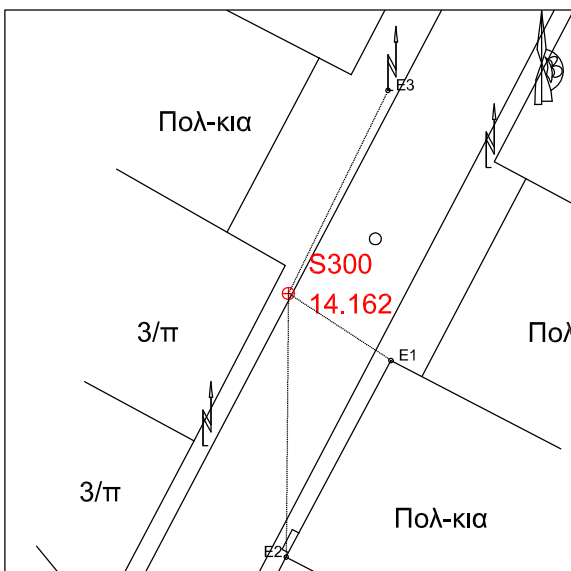

S301
 X= 409039.573
 Y=4500283.374
 H= 14.071
 E1= 9.72
 E2= 9.5
 E3= 12.52

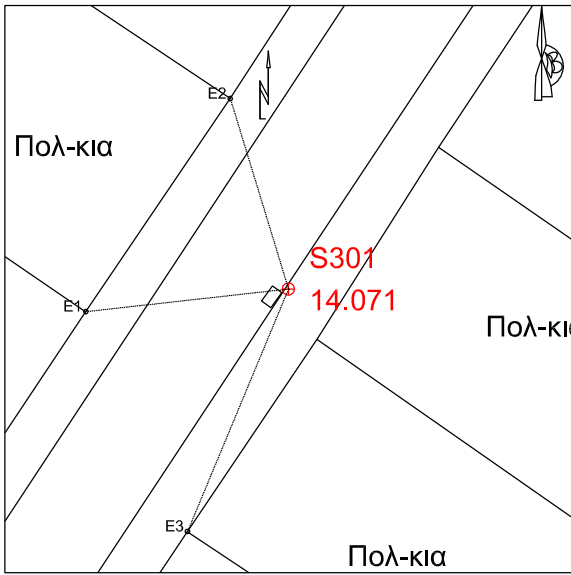

S302
 X= 409096.452
 Y=4500316.813
 H= 14.323
 E1= 6.96
 E2= 14.48
 E3= 8.22

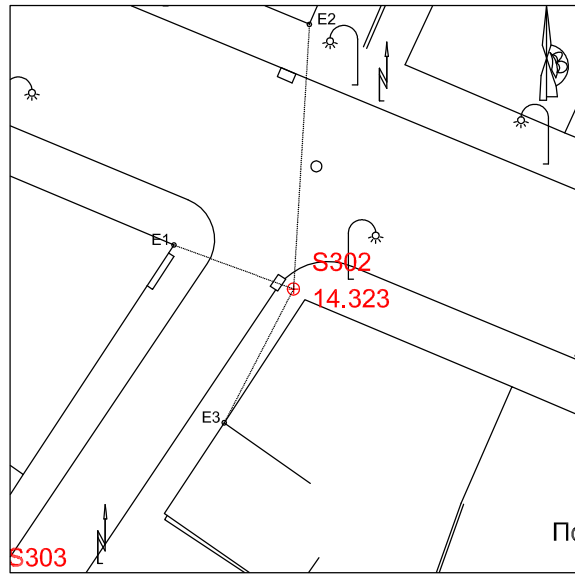

S303
 X= 409079.838
 Y=4500300.694
 H= 14.071
 E1= 10.32
 E2= 6.89
 E3= 5.32

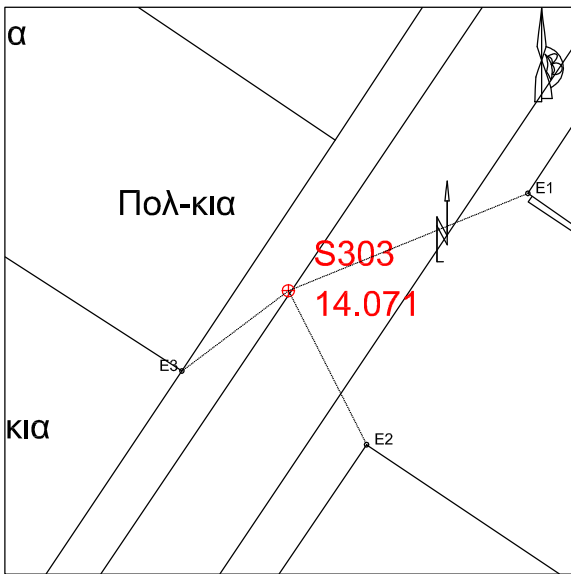

S304
 X= 409135.12
 Y=4500301.024
 H= 14.071
 E1= 6.38
 E2= 13.06
 E3= 13.84

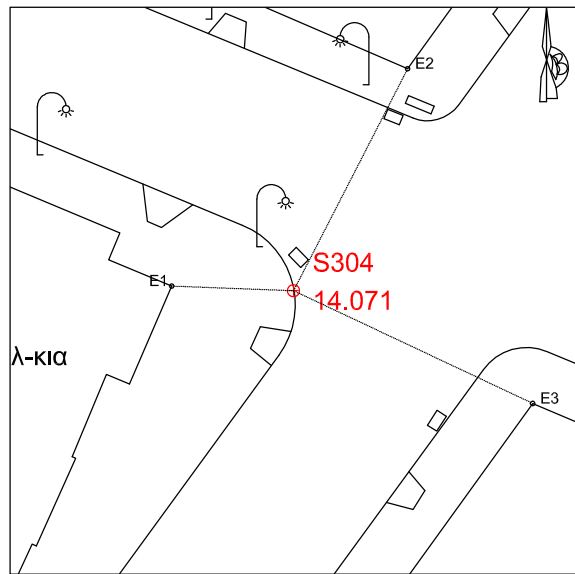

S305
 X= 408927.031
 Y=4500213.342
 H= 12.685
 E1= 6.77
 E2= 8.4
 E3= 11.82

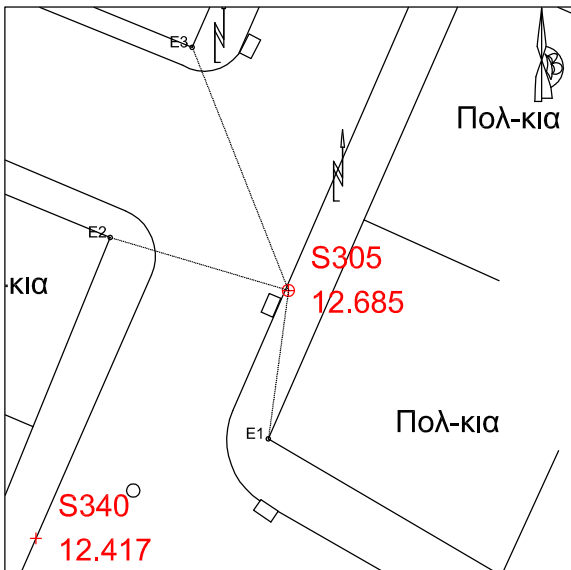

S306
 X= 408957.63
 Y=4500243.798
 H= 13.488
 E1= 12.74
 E2= 3.57
 E3= 12.41

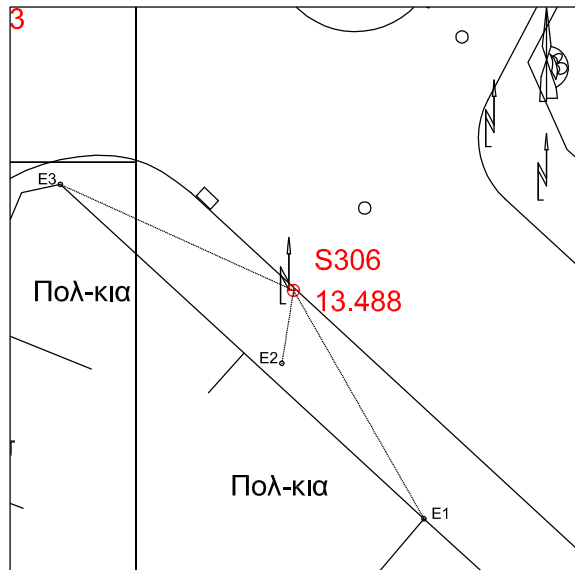

S307
 X= 408988.847
 Y=4500216.444
 H= 13.524
 E1= 9.72
 E2= 5
 E3= 16.3

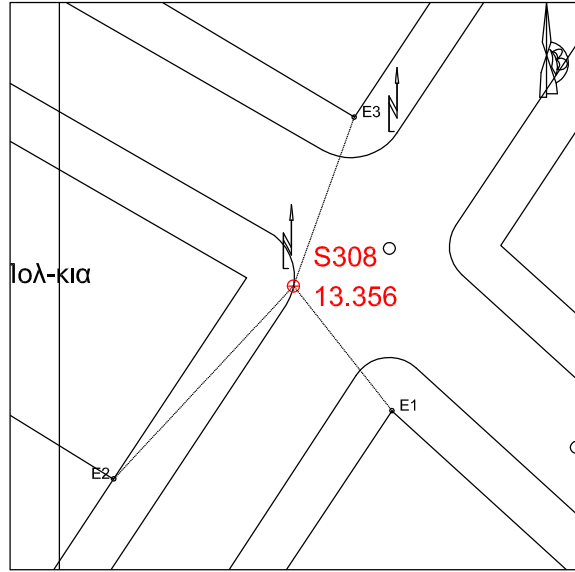
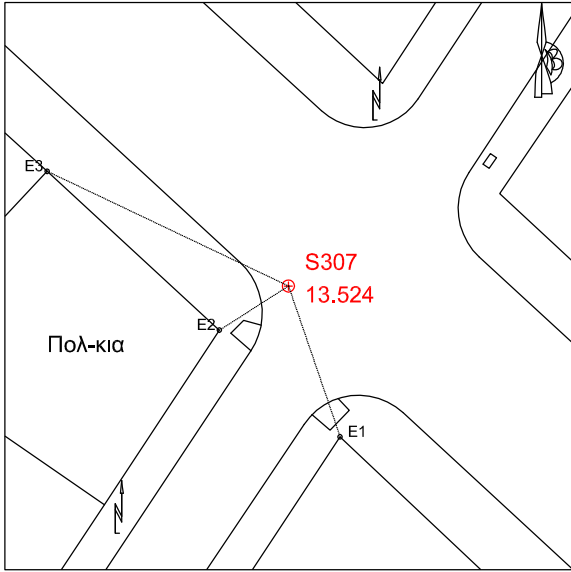

S308
 X= 408961.823
 Y=4500175.353
 H= 13.356
 E1= 8.02
 E2= 13.31
 E3= 9.07

S309
 X= 409016.596
 Y=4500207.967
 H= 13.688
 E1= 17.43
 E2= 17.94
 E3= 24.61

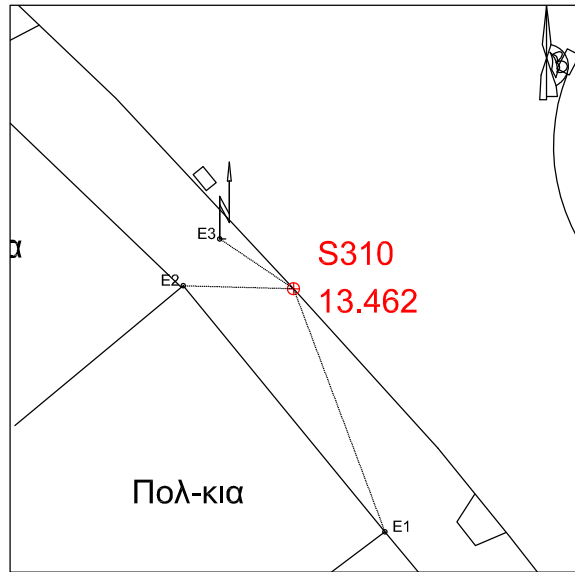
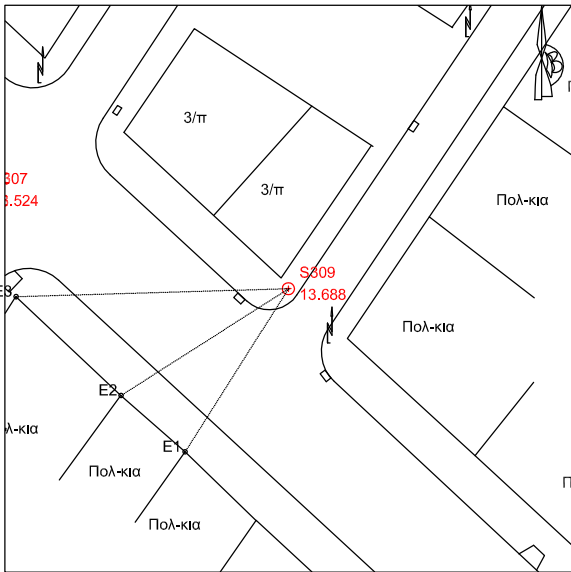

S310
 X= 409043.306
 Y=4500163.668
 H= 13.462
 E1= 10.92
 E2= 4.63
 E3= 3.74

S310A
 X= 409065.172
 Y=4500182.31
 H= 13.662
 E1= 5.55
 E2= 19.49
 E3= 15.3

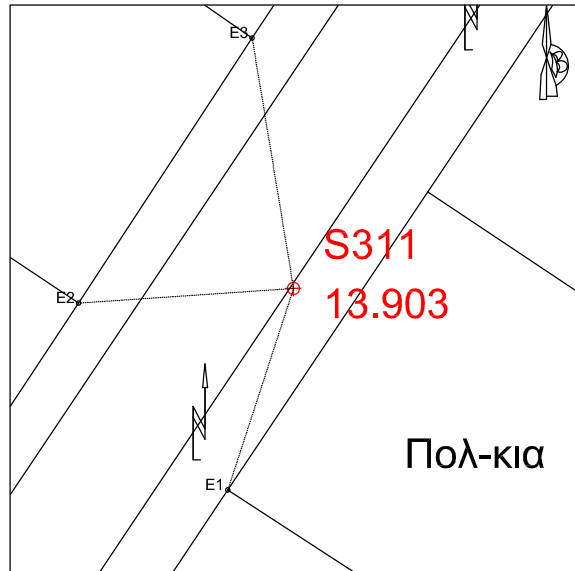
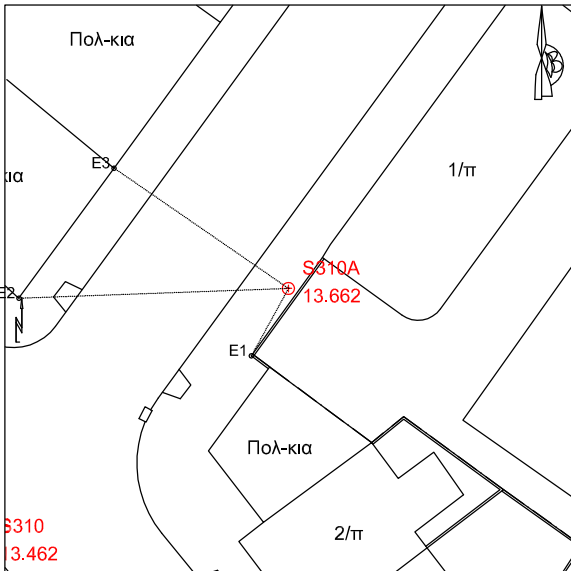

S311
 X= 409058.412
 Y=4500261.343
 H= 13.903
 E1= 7.12
 E2= 7.24
 E3= 8.53

S312
 X= 409104.267
 Y=4500240.849
 H= 13.836
 E1= 10.74
 E2= 14.68
 E3= 13.82

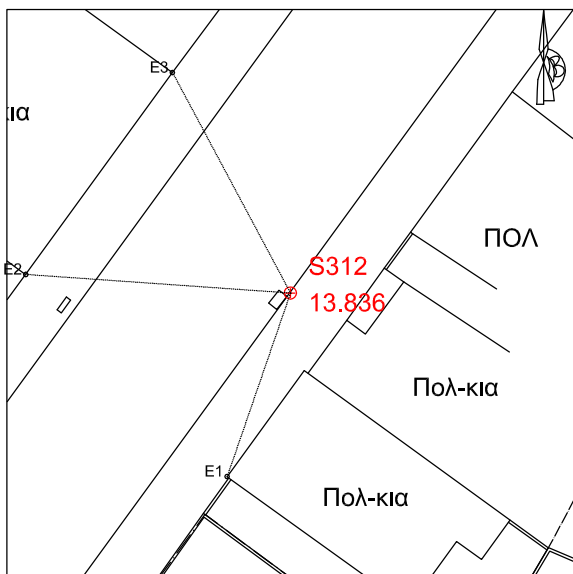

S313
 X= 409081.162
 Y=4500136.456
 H= 13.248
 E1= 13.36
 E2= 7.12
 E3= 18.56

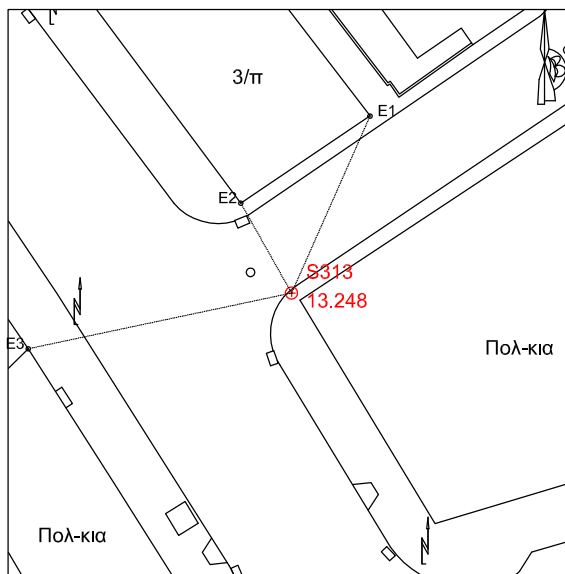

S314
 X= 409170.507
 Y=4500298.1
 H= 14.277
 E1= 12.45
 E2= 12.2
 E3= 4.93

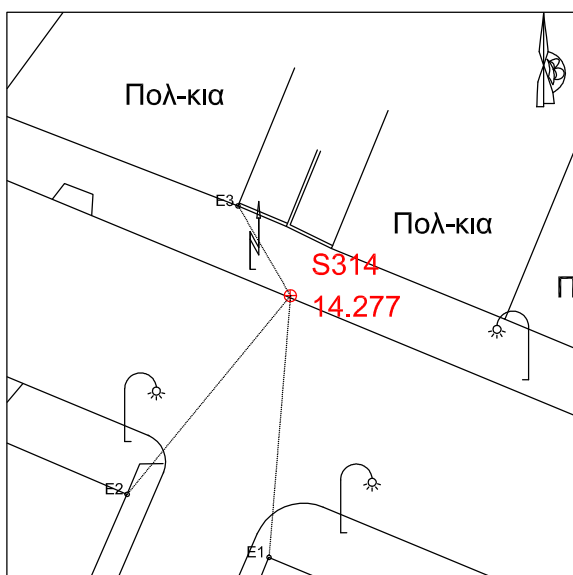

S315
 X= 409134.695
 Y=4500207.083
 H= 13.648
 E1= 7.23
 E2= 7.09
 E3= 13.52

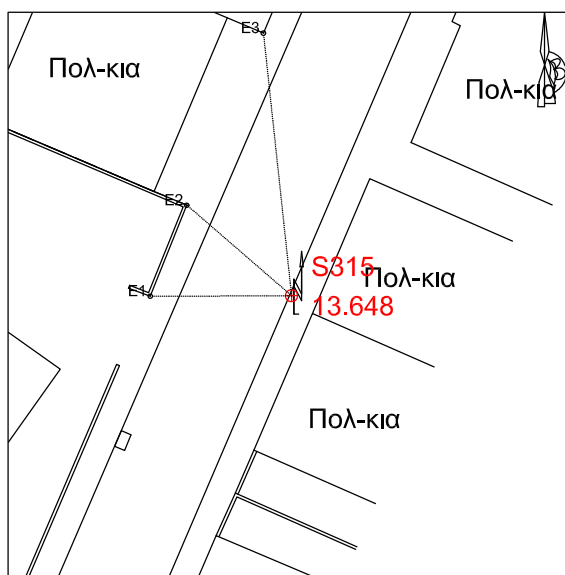

S316
 X= 409199.412
 Y=4500273.577
 H= 14.434
 E1= 10.97
 E2= 6.82
 E3= 15.93

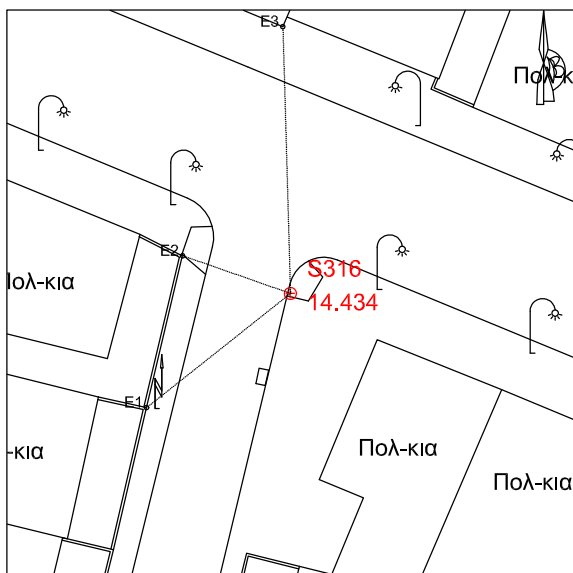

S317
 X= 409247.979
 Y=4500253.504
 H= 14.958
 E1= 13.58
 E2= 25.36
 E3= 25.39

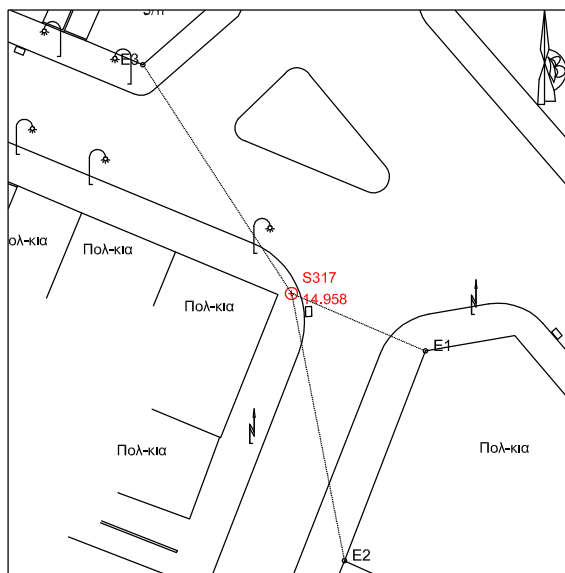

S318
 X= 409179.045
 Y=4500212.602
 H= 13.869
 E1= 10.62
 E2= 13.61
 E3= 11.55

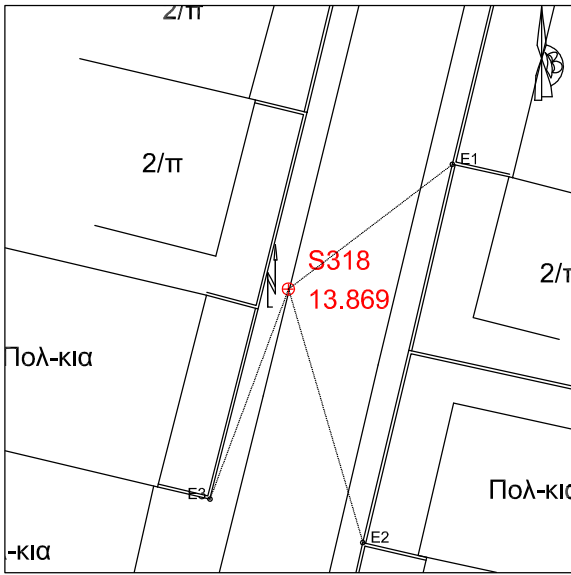

S319
 X= 409226.074
 Y=4500196.95
 H= 14.419
 E1= 11.31
 E2= 17.76
 E3= 4.78

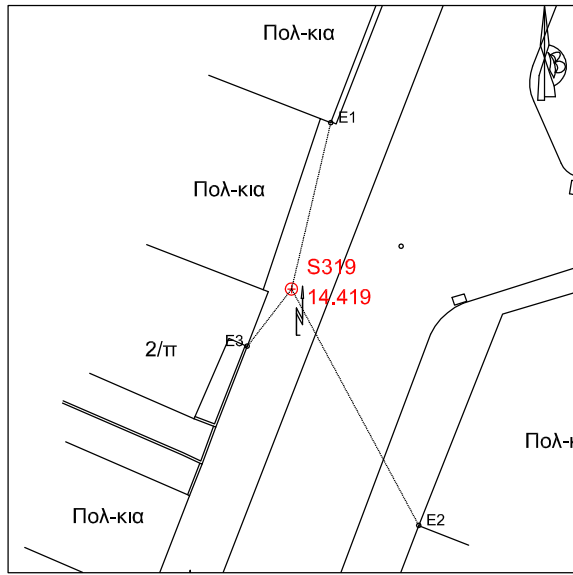

S320
 X= 409283.429
 Y=4500253.652
 H= 15.421
 E1= 8.02
 E2= 17.7
 E3= 15.23

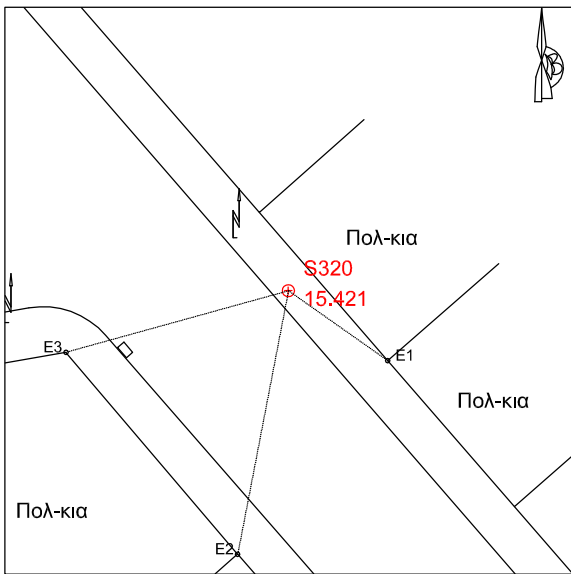

S321
 X= 409311.437
 Y=4500223.568
 H= 15.652
 E1= 19.09
 E2= 15.34
 E3= 7.6

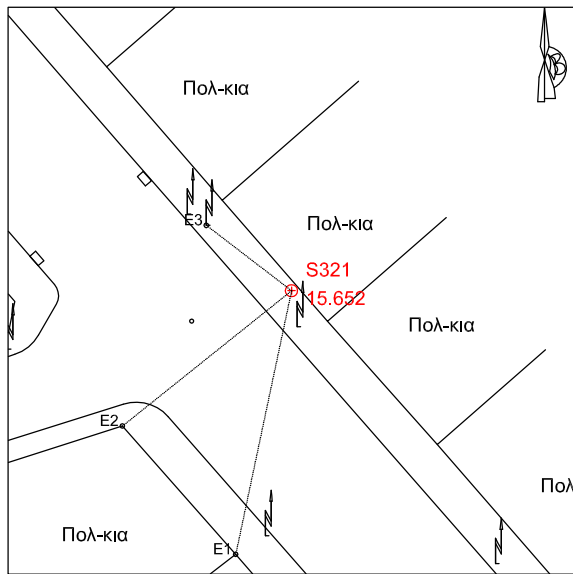

S322
 X= 409325.499
 Y=4500176.586
 H= 15.707
 E1= 11.56
 E2= 7.59
 E3= 15.55

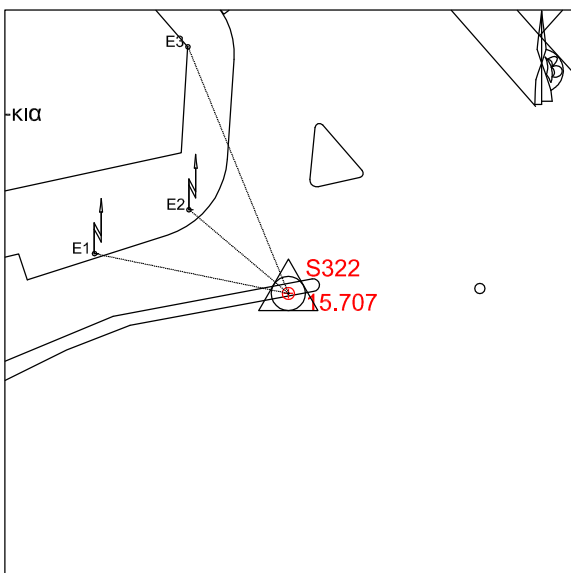

S323
 X= 409206.371
 Y=4500143.319
 H= 14.105
 E1= 18.27
 E2= 11.86
 E3= 12.14

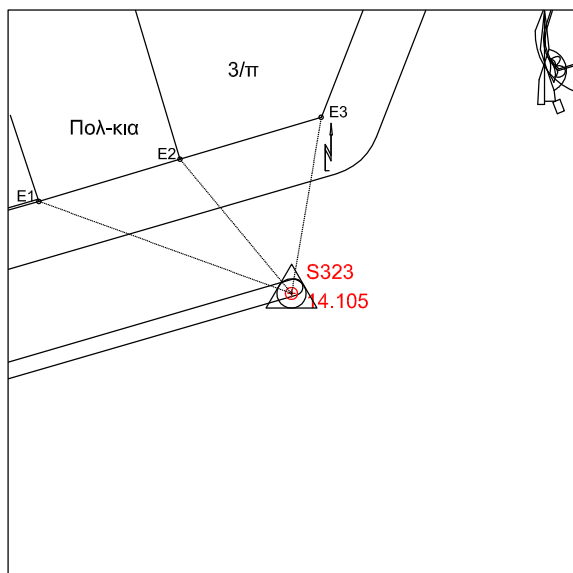

S324
 X= 409160.38
 Y=4500123.275
 H= 13.486
 E1= 22.71
 E2= 17.91
 E3= 17.29

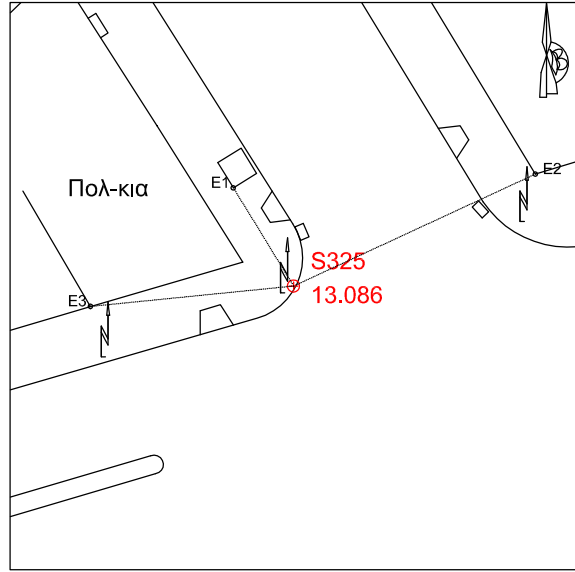
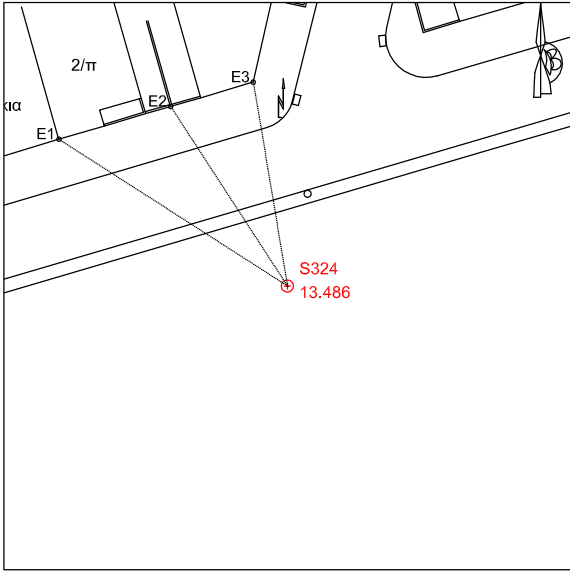

S325
 X= 409076.897
 Y=4500114.01
 H= 13.086
 E1= 6.74
 E2= 15.61
 E3= 11.96

S326
 X= 409105.194
 Y=4500153.124
 H= 13.336
 E1= 12.39
 E2= 3.69
 E3= 8.44

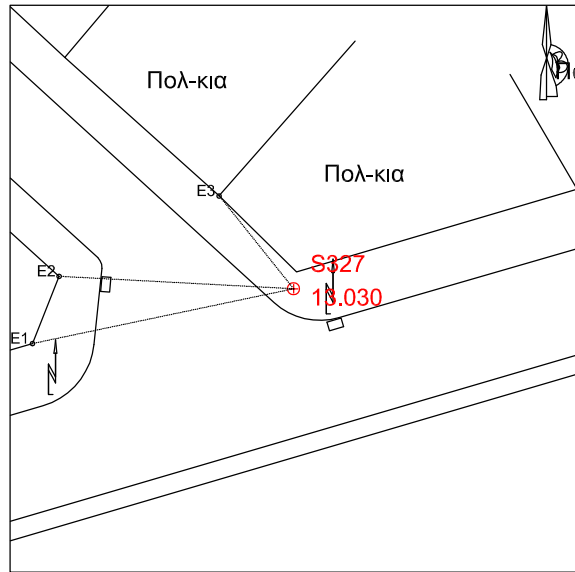
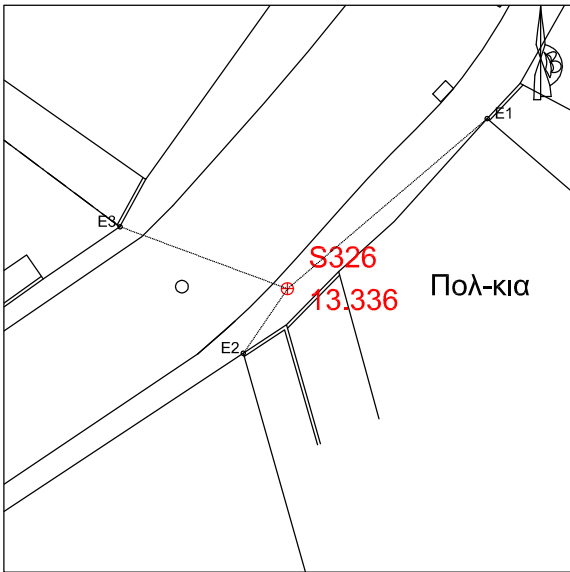

S327
 X= 409048.273
 Y=4500106.941
 H= 13.030
 E1= 15.72
 E2= 13.83
 E3= 7.01

S328
 X= 409011.326
 Y=4500096.042
 H= 12.784
 E1= 19.68
 E2= 18.97
 E3= 16.6

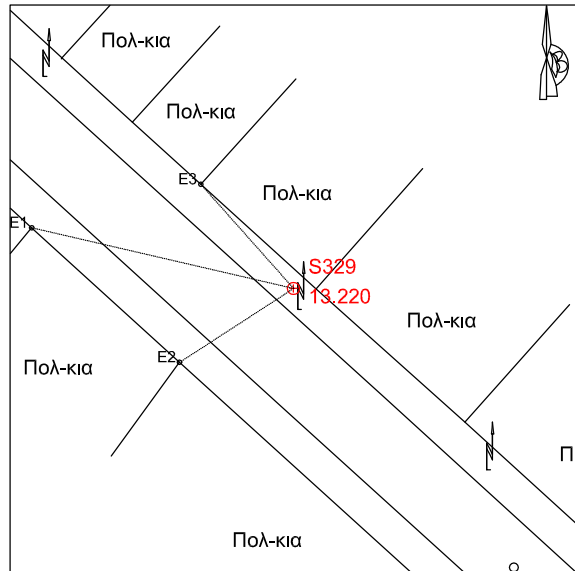
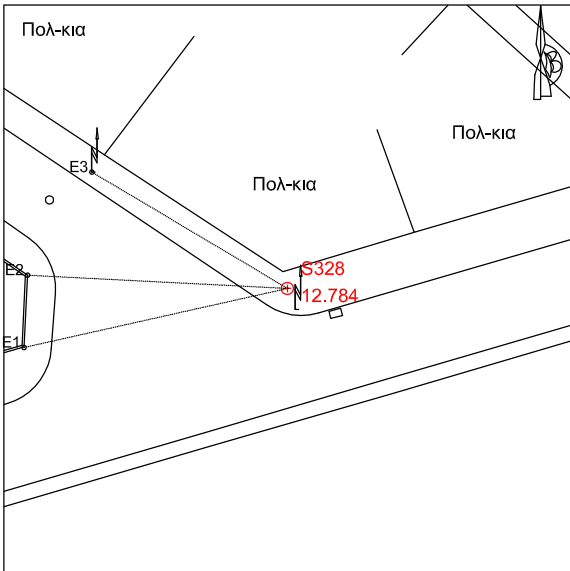

S329
 X= 409004.131
 Y=4500147.088
 H= 13.220
 E1= 18.16
 E2= 9.17
 E3= 9.42

S330
 X= 408833.658
 Y=4500101.923
 H= 11.379
 E1= 4.82
 E2= 9.6
 E3= 14.14

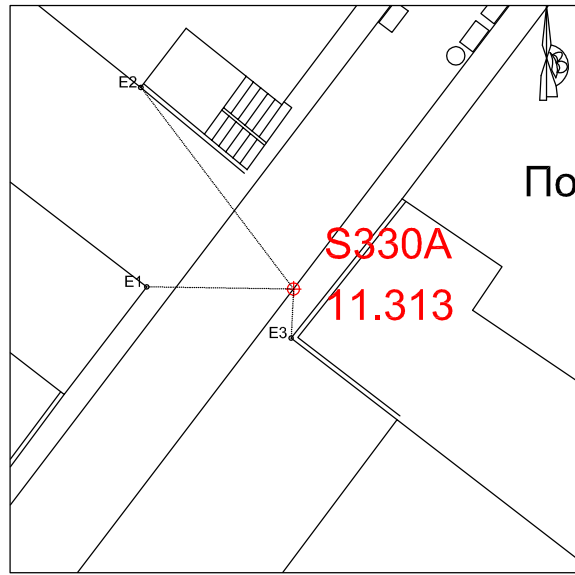
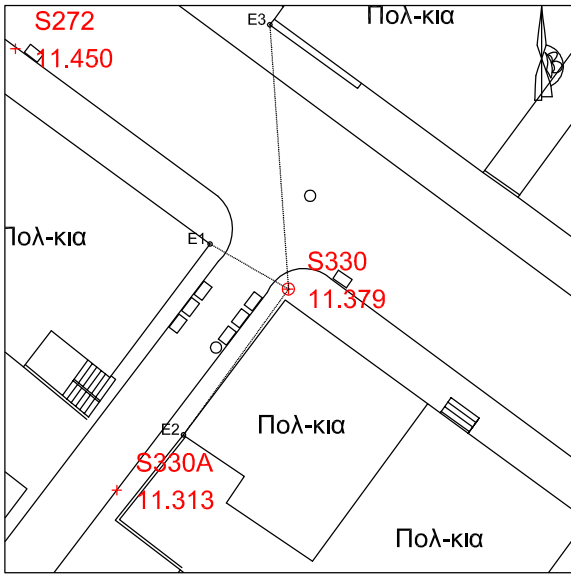

S330A
 X= 408824.505
 Y=4500091.198
 H= 11.313
 E1= 4.79
 E2= 8.25
 E3= 1.6

S330B
 X= 408809.408
 Y=4500076.689
 H= 11.237
 E1= 4.37
 E2= 8.71
 E3= 7.87

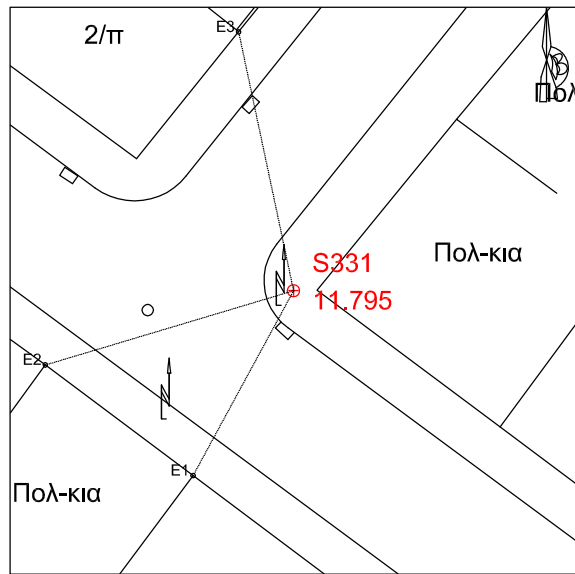
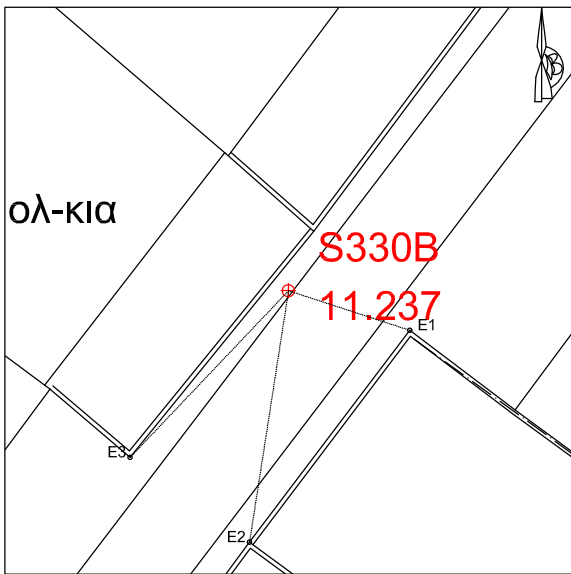

S331
 X= 408862.783
 Y=4500093.541
 H= 11.795
 E1= 11.16
 E2= 13.75
 E3= 14.05

S332
 X= 408794.459
 Y=4500049.557
 H= 11.027
 E1= 10.74
 E2= 12.98
 E3= 5.1

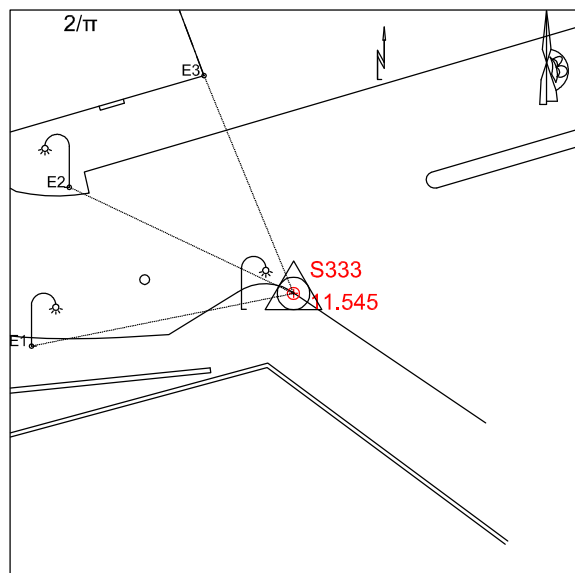
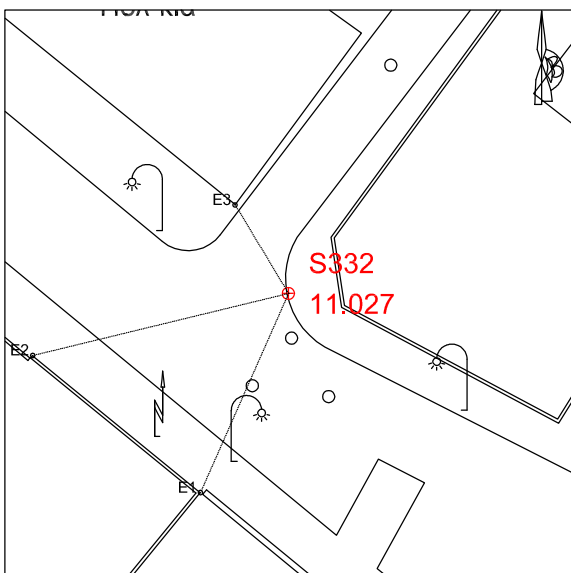

S333
 X= 408833.681
 Y=4500030.306
 H= 11.545
 E1= 16.44
 E2= 15.25
 E3= 14.47

S334
 X= 408895.476
 Y=4500053.218
 H= 12.208
 E1= 16.18
 E2= 16.77
 E3= 19.13

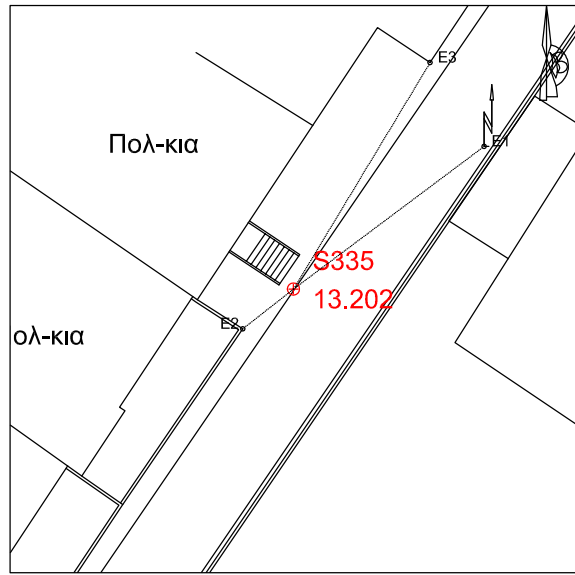
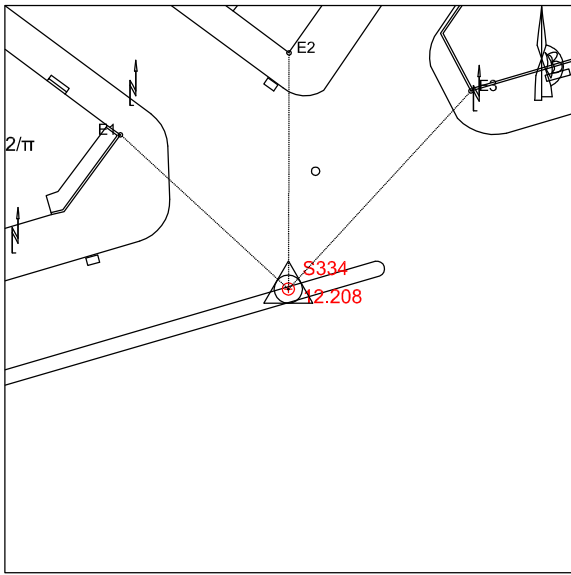

S335
 X= 408929.144
 Y=4500113.024
 H= 13.202
 E1= 12.46
 E2= 3.37
 E3= 13.84

S336
 X= 408973.049
 Y=4500075.91
 H= 12.713
 E1= 33.48
 E2= 12.61
 E3= 24.82

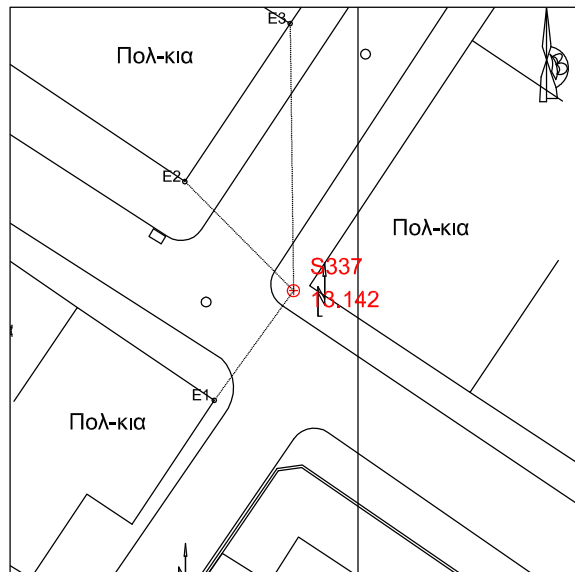
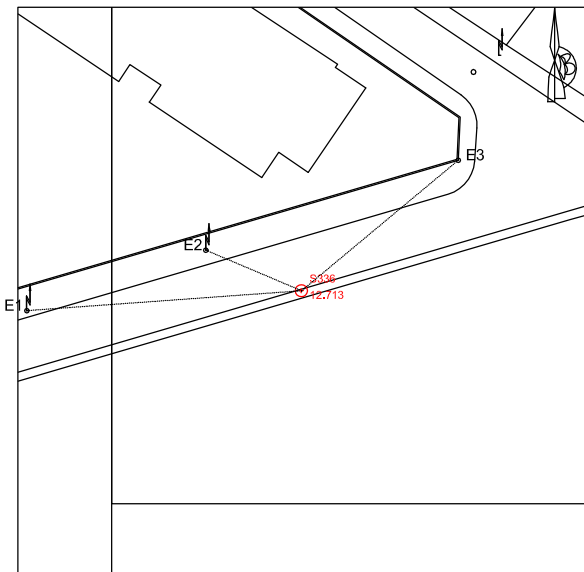

S337
 X= 408946.084
 Y=4500139.036
 H= 13.142
 E1= 8.2
 E2= 9.34
 E3= 16.2

S338
 X= 408907.274
 Y=4500165.199
 H= 12.096
 E1= 12.42
 E2= 9.12
 E3= 16.08

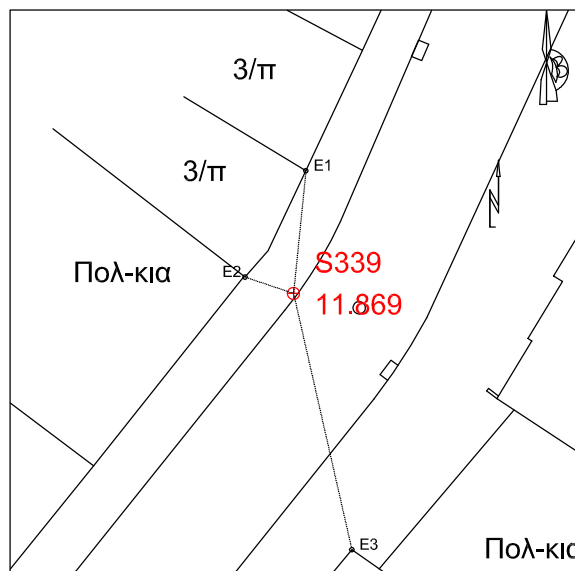
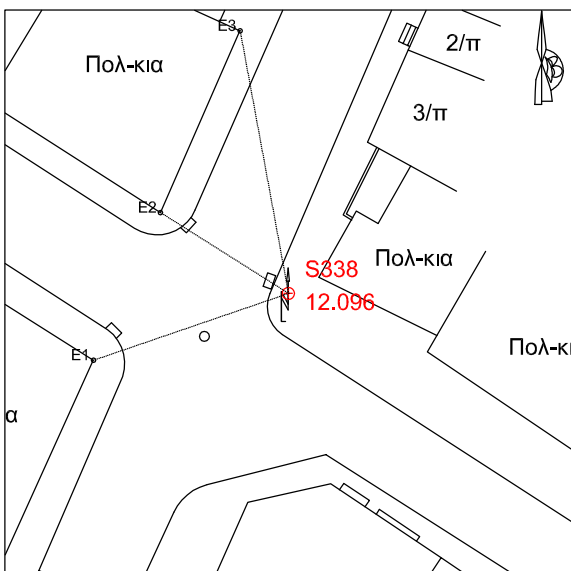

S339
 X= 408886.244
 Y=4500136.354
 H= 11.869
 E1= 5.92
 E2= 2.46
 E3= 12.61

S340
X= 408915.616
Y=4500202.132
H= 12.417
E1= 14.01
E2= 6.12
E3= 10.76

